



**WITTEX**  
INTERNATIONAL

Premium • Precision • Excellence



# DENTAL INSTRUMENTS

---

## CATALOG



[www.wittex.com](http://www.wittex.com)



[wittex.export@gmail.com](mailto:wittex.export@gmail.com)

Welcome to the **WITTEX INTERNATIONAL** Dental Instruments Catalog - your trusted partner in precision-driven dental solutions.

We are proud to present our comprehensive range of high-quality dental instruments, carefully designed to meet the daily clinical demands of modern dental professionals. Within these pages, you will find a complete selection of instruments for general dentistry, restorative procedures, periodontal treatment, oral surgery, orthodontics, endodontics, implantology, and cosmetic dentistry.

Each instrument is manufactured from premium German stainless steel under strict quality control standards. Our production process ensures exceptional precision, superior durability, corrosion resistance, and long-lasting performance - delivering reliability you can trust in every procedure.

At **WITTEX INTERNATIONAL**, we understand that precision and comfort are essential in dentistry. That is why our instruments are ergonomically designed to provide optimal control, reduced hand fatigue, and maximum efficiency during clinical use.

This catalog represents more than just our products - it reflects our commitment to quality, safety, and innovation in dental care.

We invite you to explore our collection and discover how **WITTEX INTERNATIONAL** Dental Instruments can enhance your daily practice. We are pleased to offer personalized quotations tailored to your needs, along with competitive pricing, reliable delivery schedules, and guaranteed manufacturing excellence.

In addition, we provide custom manufacturing services for specialized dental instruments not listed in our standard catalog.

Welcome to the **WITTEX INTERNATIONAL** Dental Family - where precision meets excellence in dentistry.



01 to 38	DIAGNOSTIC, PERIODONTAL INSTRUMENTS
39 to 89	RESTORATION SET-UP
90 to 103	LABOURATORY SET-UP
104 to 123	ENDODONTICS & ENDOMICROSURGERY
124 to 149	ROOT ELEVATORS
150 to 185	EXTRACTING FORCEPS
186 to 229	MAXIOFACIAL SURGERY
230 to 245	ORTHODONTICS
246 to 287	IMPLANTS INSTRUMENTS, IMPLANTS SURGERY KIT
288 to 298	IMPRESSION TRAY
299 to 315	HOLLOWEARS

## Our Scalers

*Compare our scalers and curettes with the best in the industry and you will immediately recognize we are equal in every way but one... price.*

*Note the deep precision knurling for better tactile feel. The same high-grade stainless steel tips, the same light weight (under 18 grams) for less hand fatigue, the same professional craftsmanship, and surpassing the highest industry standards. of course, any manufacturer can make these claims, but we guarantee and certify ours.*

DIAGNOSTIC, PERIODONTAL



**Beautiful, blasted finish on center bar.**

**Deep cross-cut, knurling for better non-slip control.**

**Titanium coated color to protect the blood stains.**

**CNC machined for excellent balance, precision and consistency.**

**9.5 mm diameter for easier handling and better tactile sensitivity ....**

**Better comfort throughout the day.**

**Evenly balanced for consistent control when switching from tip to tip.**

**90 mm length of handles without tips.**

**Dental Hand Instruments**

The types of hand instruments can be categorized based on their function:

Examining the mouth and teeth  
Scaling or professional cleaning of teeth  
Cutting teeth and removing cavities  
Placing and condensing filling materials  
Carving and finishing dental fillings  
Miscellaneous types  
Instruments used for examining the mouth and teeth

Mouth mirrors are used to examine the condition of the teeth and mouth, as well as to retract the tongue and cheeks upon examination.

Probes– There are many probes available but the main types are the straight probe, Briault probe and periodontal probe.

The straight probe is sharp and it is used to examine cavities in the dentine region as well as to check the margins of restorations or fillings. The Briault probe is also sharp and it is used to detect the junction between the enamel and dentine. Briault can also be used to detect tartar hidden in the gum pockets.

A periodontal probe can be used to measure the depth of the gum pockets and for other measurements. Instruments for cutting and scraping tissues and deposits

Scalers remove tartar (calculus) on the tooth surface as well as those hidden in the gum pockets. They can also be used to remove other surface deposits and temporary crowns.

Excavators are used to remove softened dentine and temporary fillings. The back of the blade can also be used for placing linings between filling materials. Sometimes excavators can be used for carving metal or amalgam fillings. Chisels are used to remove unsupported enamel during cavity preparation. Unsupported enamel can be harmful for it can compromise the longevity of the filling if not removed. Hatchets and hoes have similar purposes to chisels. Instruments used for placing and condensing filling materials

Plastic instruments convey and shape filling materials and are usually flat blades that do not use heavy pressure. Some instruments have rounded ends for shaping and burnishing the surfaces of fillings. Plastic instruments are usually made of stainless steel for most materials though there are also thin Teflon-coated or titanium nitride instruments which are non-stick for composite fillings. Condensers or pluggers are used for compressing and forming filling materials. Heavy pressure is applied on use therefore these instruments are usually used for metal or amalgam fillings. Instruments used for carving and finishing fillings  
Carving and finishing instruments have sharp or semi-sharp blades of various shapes. They are used to carve materials by cutting and scraping.



**VALUED BUYERS**

Compare our scalers and curettes with the best in the industry and you will immediately recognize we are equal in every way but one... price. Note the deep precision knurling for better tactile feel. The same high-grade stainless steel tips, the same light weight (under 20 grams) for less hand fatigue, the same professional craftsmanship, and surpassing the highest industry standards. Of course, any manufacturer can make these claims, but we guarantee and certify ours. We regularly manufacturing below articles in showing handles & pattern A to L for better grip & perfection. We are also fully equipped & capable to develop these instruments as per your own specific requirements & demands in materials, sizes, shapes and patterns.

DIAGNOSTIC, PERIODONTAL



**HANDLE DESIGN-1**



**HANDLE DESIGN-2**



**HANDLE DESIGN-3**



**HANDLE DESIGN-4**



**HANDLE DESIGN-5**



**HANDLE DESIGN-6**



**HANDLE DESIGN-7**



**HANDLE DESIGN-8**



**HANDLE DESIGN-9**



**HANDLE DESIGN-10**



**HANDLE DESIGN-11**



**HANDLE DESIGN-12**



**HANDLE DESIGN-13**



**HANDLE DESIGN-14**



**HANDLE DESIGN-15**



**HANDLE DESIGN-16**



**HANDLE DESIGN-17**



**HANDLE DESIGN-18**



**HANDLE DESIGN-19**



**HANDLE DESIGN-20**



**HANDLE DESIGN-21**



**HANDLE DESIGN-22**

■ Ручки для зеркал  
■ Manches pour miroirs à bouche  
■ Mundspiegelgriffe

■ Ручки для дзеркал  
■ Mangos para espejos de boca  
■ مقابض لعرايا الفم



**Article#**  
W11-001  
Pack of 12 Pcs

Plain

**Article#**  
W11-002 Fig.3 Ø20mm  
W11-003 Fig.4 Ø22mm  
W11-004 Fig.5 Ø24mm  
W11-005 Fig.6 Ø26mm



**Article#**  
W11-006  
Pack of 12 Pcs

Cone-socket Plain

**Article#**  
W11-007 Fig.3 Ø20mm  
W11-008 Fig.4 Ø22mm  
W11-009 Fig.5 Ø24mm



**Article#**  
W11-010  
Pack of 12 Pcs

Magnifying

**Article#**  
W11-011 Fig.3 Ø20 mm  
W11-012 Fig.4 Ø22 mm  
W11-013 Fig.5 Ø24 mm



**Article#**  
W11-014  
Pack of 12 Pcs

Cone-socket Magnifying

**Article#**  
W11-015 Fig.3 Ø20mm  
W11-016 Fig.4 Ø22mm  
W11-017 Fig.5 Ø24mm



**Article#**  
W11-018  
Pack of 12 Pcs

Rhodium

**Article#**  
W11-019 Fig.3 Ø20mm  
W11-020 Fig.4 Ø22mm  
W11-021 Fig.5 Ø24 mm



**Article#**  
W11-022  
Pack of 12 Pcs

Cone-socket Rhodium

**Article#**  
W11-023 Fig.3 Ø20mm  
W11-024 Fig.4 Ø22mm  
W11-025 Fig.5 Ø24mm

**DOUBLE SIDE MOUTH MIRRORS RHODIUM**

**PLANE/RHODIUM FRONT SURFACE**



**Article#**  
W11-026  
No. 4  
Rhodium



**Article#**  
W11-027  
No. 5  
Rhodium



**Article#**  
W11-028  
22mm  
W11-029  
24mm  
N. 3  
Front  
Surface



**Article#**  
W11-300  
Long Mirrors  
Rhodium  
18.0 x 33.0 mm

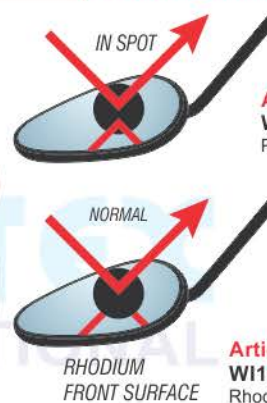

**Article#**  
W11-031  
Plane

**Article#**  
W11-032  
Rhodium



DIAGNOSTIC, PERIODONTAL



**Article#** W11-33 Mirror Handle Solid Stem with Rule 35mm

**MICRO MIRROR HANDLE SET 4 PCS**  
**Article#** W11-034



**Article#** W11-035  
Handle for laryngeal mirrors  
Laryngeal mirrors  
Specchietti laringei

**Article#**

- W11-036 (ø 10 mm)
- W11-037 (ø 12 mm)
- W11-038 (ø 14 mm)
- W11-039 (ø 16 mm)
- W11-040 (ø 18 mm)
- W11-041 (ø 20 mm)
- W11-042 (ø 22 mm)
- W11-043 (ø 24 mm)
- W11-044 (ø 26 mm)
- W11-045 (ø 28 mm)
- W11-046 (ø 30 mm)



3x9mm 3x6mm 5mm round 3mm round



**Article#** W11-047



**Article#** W11-048



**Article#** W11-049



**Article#** W11-050



**Article#** W11-051  
Ultra Light Aluminum Made

**PERIODONTAL  
SECTION 1**

■ Ручки для зеркал  
■ Manches pour miroirs à bouche  
■ Mundspiegelgriffe

■ Ручки для дзеркал  
■ Mangos para espejos de bica  
■ مقابض لمرآيا الفم

DIAGNOSTIC, PERIODONTAL



**Article# W11-052**  
Hollow Mirror Handle Round Ø 10 mm



**Article# W11-053**  
Hollow Mirror Hexagonal Handle Ø 8 mm



**Article# W11-054**  
Hollow Mirror Hexagonal Handle Ø 8 mm



**Article# W11-055**  
Hollow Mirror Hexagonal Handle Ø 10 mm



**Article# W11-056**  
Hollow Mirror Hexagonal Handle Ø 8 mm



**Article# W11-057**  
Hollow Mirror Handle Ø 10 mm



**Article# W11-058**  
Hollow Mirror Handle Ø 8 mm



**Article# W11-059**  
Mirror Handle Autoclavable Material Available in Various Colours Ø 9.5 mm



**Article# W11-060**  
Mirror Handle Autoclavable Material Available in Various Colours Ø 9.5 mm



**Article# W11-061**  
Mirror Handle Silicon Grip Autoclavable Available in Various Colours



**Article# W11-062**  
Mirror Handle Solid Ø 6 mm



**Article# W11-063**  
Mirror Handle Solid Ø 6 mm



**Article# W11-064**  
Mirror Handle Solid Octagonal Ø 6 mm



**Article# W11-065**  
Mirror Handle Solid Stem with Rule 35mm



**Article# W11-066**  
Cone-Socket Solid Octagonal Ø 6 mm



**Article# W11-067**  
Cone-socket Solid Ø 6 mm



**Article# W11-068**  
Cone-socket Hexagonal Handle Ø 6 mm

Cone-Socket Mirror Handle

**PERIODONTAL  
SECTION 1**

■ Комплект для обследования  
■ Ensemble d'examen  
■ Prüfungssatz

■ Экзаменаційний набір  
■ Conjunto de examen  
■ مجموعة الفحص

DIAGNOSTIC, PERIODONTAL

**Article# W11-69**

First Aid Examination kit Set of 3 Pieces



**Article# W11-70**

Examination Set of 3 Pcs



**Article# W11-71**

First Aid Examination Set of 4 Pieces



**Article# W11-72**

First Aid Examination Set of 3 Pieces



**Article# W11-73**

First Aid Examination Set of 3 Pieces



**W11-74**

First Aid Examination Set of 3 Pieces



**W11-75**

First Aid Examination Set of 3 Pieces



Зонды  
Sondes  
Zahnsonden

Зонди  
Sondas  
المستكشفين

**W1-76 Dental Probe - Flexible SET OF 5 PCS.**



Article# W1-77  
Fig-9 Dental Probe - Flexible

Article# W1-78  
Fig-23 Dental Probe - Flexible

Article# W1-79  
Fig-8 Dental Probe - Flexible

Article# W1-80  
Fig-3A Dental Probe - Flexible

Article# W1-81  
Fig-17 Dental Probe - Flexible

**W1-171 Dental Probe - Flexible SET OF 5 PCS.**



Article# W1-82  
Fig-23 Dental Probe - Flexible

Article# W1-83  
Fig-17 Dental Probe - Flexible

Article# W1-84  
Fig-9 Dental Probe - Flexible

Article# W1-85  
Fig-8 Dental Probe - Flexible

Article# W1-86  
Fig-3a Dental Probe - Flexible

- Large diameter handle 9.5mm is used for all explorers.
- The thin, unbreakable, yet flexible tips from a special steel alloy guarantee an extremely long life.
- This section includes the most commonly use diagnostic explorers.
- All explorers are,
- Made from Stainless Steel Material
- Ultrasound Resistant & Completely Sterilizable

Fig. 3A;  
Fig. 8;  
Fig. 9;  
Fig. 17;  
Fig. 23;  
Fig. 3A  
Fig. 8  
Fig. 9  
Fig. 17  
Fig. 23

**W1-87 Dental Probe - Extra Flexible SET OF 8 PCS.**



Article# W1-88 Exp 17

Article# W1-89 Exp 23

Article# W1-90 Exp 9

Article# W1-91 Exp 8

Article# W1-92 Exp 6A

Article# W1-93 Exp 6L

Article# W1-94 Exp 6

Article# W1-95 Exp 3A

DIAGNOSTIC, PERIODONTAL

A dental explorer or sickle probe is an instrument in dentistry commonly used in the dental armamentarium. A sharp point at the end of the explorer is used to enhance tactile sensation.

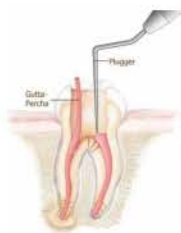

Economy Line Handle B

Economy Line Handle C



Зонды  
Sondes  
Zahnsonden

Зонди  
Sondas  
المستكشفين

**W11-96 DENTAL PROBE RIGID SINGLE ENED SET OF 5 PCS.**



Article# W11-97 Fig-6 Dental Probe Rigid



Article# W11-98 Fig-8 Dental Probe Rigid



Article# W11-99 Fig-9 Dental Probe Rigid



Article# W11-100 Fig-17 Dental Probe Rigid



Article# W11-101 Fig-23 Dental Probe Rigid

**W11-102 RIGID PROBES SINGLE ENED SET OF 8 PCS.**



Article# W11-103 Probe



Article# W11-104 Probe



Article# W11-105 Probe



Article# W11-106 Probe



Article# W11-107 Probe



Article# W11-108 Probe



Article# W11-109 Probe

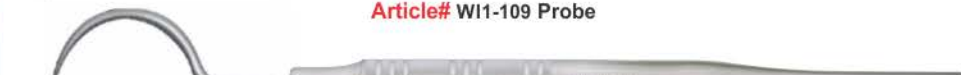

Article# W11-110 Probe

Зонды  
Sondes  
Zahnsonden

Зонди  
Sondas  
المستكشفين

**W11-111 Dental Probe - Flexible Duple Ended SET OF 9 PCS.**



Made of high quality stainless steel. Designed to assess periodontal pocket depths, attachment levels, anatomy configurations and gingival bleeding. Measures the sulcus or pocket depth of the periodontic of each tooth. Working end has calibrated markings in millimeters.

Clinical probing depths and measurements of attachment loss obtained with periodontal probes are a practical and important method of determining a patient's periodontal status. When selecting a probe for measuring pocket depth, you should consider selecting a probe that has markings that you are familiar with. This section includes the most commonly used Probes.

Stainless Steel Material  
Ultrasound Resistant  
completely Sterilizable

The thin, unbreakable, yet flexible tips from a special steel alloy guarantee an extremely long life.

All our Periodontal probes are prepared by a high-speed cutting machine.

Working parts are in very fine to very precise dimensions and the color markings are (do not dissolve or fade off) ultrasound-resistant.

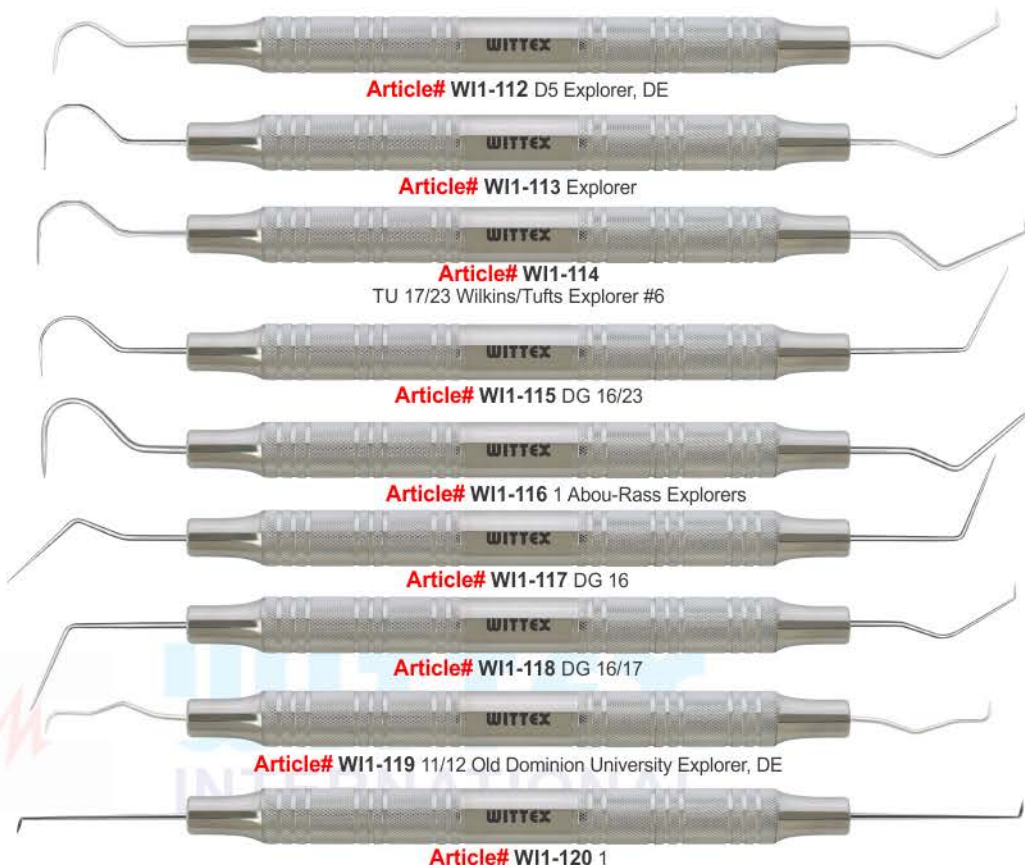

**Article# W11-112** D5 Explorer, DE

**Article# W11-113** Explorer

**Article# W11-114**  
TU 17/23 Wilkins/Tufts Explorer #6

**Article# W11-115** DG 16/23

**Article# W11-116** 1 Abou-Rass Explorers

**Article# W11-117** DG 16

**Article# W11-118** DG 16/17

**Article# W11-119** 11/12 Old Dominion University Explorer, DE

**Article# W11-120** 1

**W11-121 DEPTH MEASURING PROBES SET OF 4 PCS.**

Available Handles  
A,B,C,D

Economy Line Handle A

Economy Line Handle B



**Article# W11-122**  
UNC

**Article# W11-123**  
UNC

**Article# W11-124**  
Cp12

**Article# W11-125**  
Periodontal Probe, UNC 15 CNC North Carolina,  
graduation 1-15 in mm steps



WI-126 WILLIAMS PROBES SINGLE ENDED SET OF 7 PCS.

Function

These are double-ended instruments with an explorer on one end and a probe on the other end. An Explorers is excellent for dental examinations and charting. This section includes the most commonly used Explorers.

These are, Made from Stainless Steel Material  
 Ultrasound Resistant &  
 Completely Sterilizable Color Coded  
 Large diameter handle 9.5mm is used for all Explors



Article# WI1-127 Williams

Article# WI1-128 Merrit A

Article# WI1-129 Merrit B

Article# WI1-130 Goldman Fox

Article# WI1-131 University of Michigan

Article# WI1-132 Fig. 26G

Article# WI1-133 Fig. 26G/A

WI-134 WILLIAMS PROBES DOUBLE ENDED SET OF 8 PCS.



Article# WI1-135  
 6/Williams Color Coded Explorer, 1-2-3-5-7-8-9-10, DE

Article# WI1-136  
 23/UNC12 University of North Carolina Color Coded Explorer, 1-12mm, DE

Article# WI1-137  
 UNC15 23/UNC15 University of North Carolina Color Coded Explorer, 1-15mm, DE

Article# WI1-138  
 3A/UNC15 University of North Carolina Color Coded Explorer, 1-15mm

Article# WI1-139 Goldman Fox Fig. 17

Article# WI1-140 University of Michigan Fig. 17

Article# WI1-141 Williams Fig. 17

Article# WI1-142 Goldman Fox Fig. 16

Function

The thin, unbreakable, yet flexible tips from a special steel alloy guarantee an extremely long life.  
 All our Periodontal probes are prepared by a high-speed cutting machine.  
 Working parts are in very fine to very precise dimensions and the color markings are (do not dissolve or fade off) ultrasound-resistant.



**W11-143 WILLIAMS PROBES SINGLE ENDED SET OF 10 PCS.**



**W11-154 WILLIAMS PROBES DOUBLE ENDED SET OF 8 PCS.**



DIAGNOSTIC, PERIODONTAL

Зонды  
Sondes  
Zahnsonden

Зонди  
Sondas  
المستكشفين

**W11-163 ANTERIOR SINGLE ENDED SET OF 9 PCS.**



**Article# W11-173 LUKS SET OF 4 PCS.**



Зонды  
Sondes  
Zahnsonden

Зонди  
Sondas  
المستكشفين

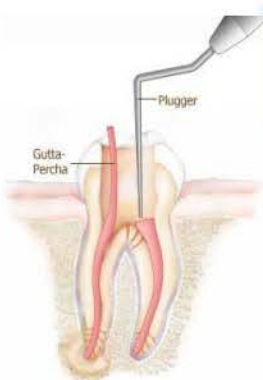

Article# W11-178  
POSTERIOR SINGLE ENDED SET OF 9 PCS.



- |            |            |
|------------|------------|
| Зонды      | Зонди      |
| Sondes     | Sondas     |
| Zahnsonden | المستكشفين |



**Endo Pluggers**

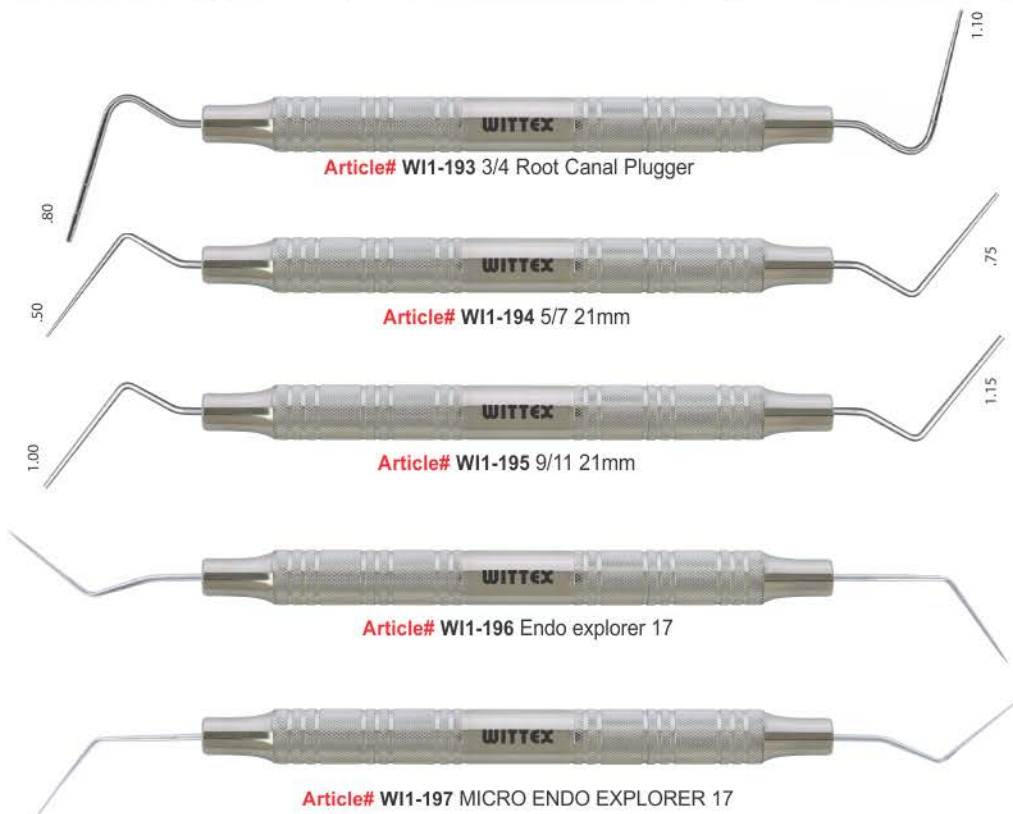

**PERIODONTAL  
SECTION 1**

■ Зонды      ■ Зонди  
■ Sondes      ■ Sondas  
■ Zahnsonden      ■ المستكشفين

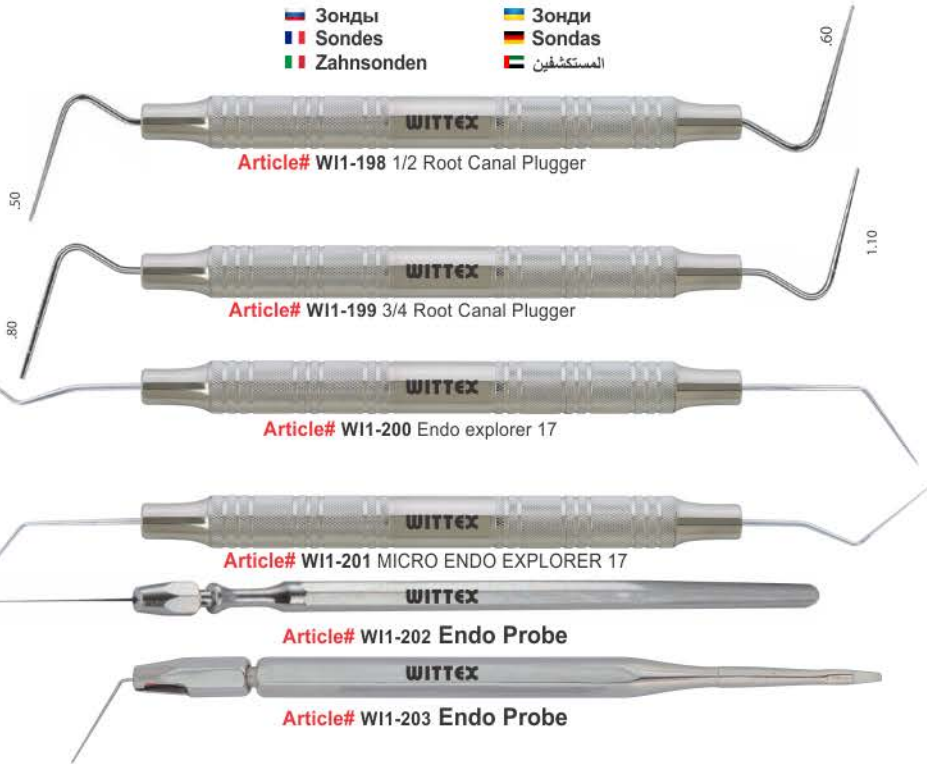

**Article# W11-198** 1/2 Root Canal Plugger

**Article# W11-199** 3/4 Root Canal Plugger

**Article# W11-200** Endo explorer 17

**Article# W11-201** MICRO ENDO EXPLORER 17

**Article# W11-202** Endo Probe

**Article# W11-203** Endo Probe

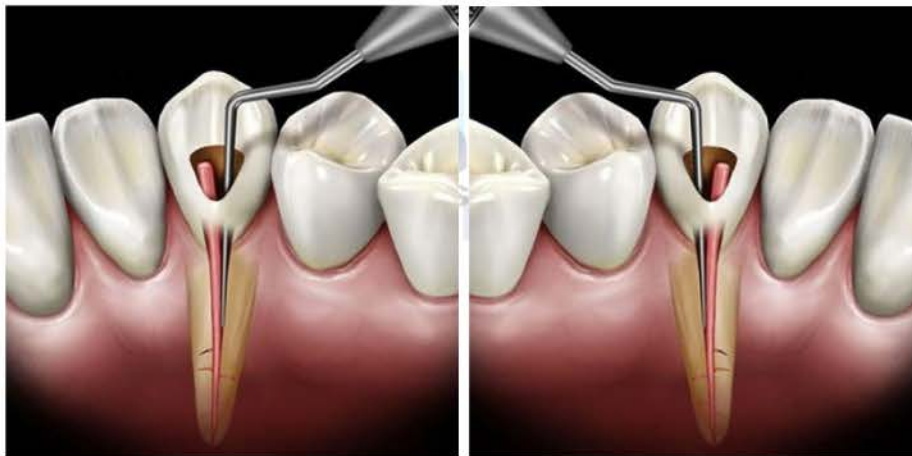

DIAGNOSTIC, PERIODONTAL



**Article# W11-204**

**HAND PLUGGER SET OF 4 PCS**

**Article# W11-205**

**Article# W11-206**

Stainless steel-Tip  
Taper: 02  
Tip Size: 1.3mm

**Article# W11-207**

Stainless steel-Tip  
Taper: 02  
Tip Size: 0.80mm

**Article# W11-208**

Stainless steel-Tip  
Taper: 02  
Tip Size: .75mm

**Article# W11-209**

Stainless steel-Tip  
Taper: 02  
Tip Size: .68mm



■ Кюрети    ■ Кюрети  
■ Curetas    ■ Curette  
■ Kùretten    ■ كرتس

**Gracey Curettes -Standard SET OF 9 PCS.**

Gracey Curette Blade design is offset from the terminal shank at 70°. This creates one cutting edge which is referred to as the lower edge. Gracey Curettes are area specific to allow for deep scaling, root planning and periodontal debridement. The offset blade provides a perfect working angulation for the tooth surface. Gracey Curettes are used in a set to completely scale the dentition.

In the following chart you can find the exact application areas for the various Gracey Curettes.

- Gracey #1/2  
For all surface of the front teeth and canines.
- Gracey #3/4 & 5/6  
For all surface of the front teeth and bicuspids.
- Gracey #7/8 & 9/10  
For all facial and oral surfaces of the bicuspids and molars.
- Gracey #11/12 & 15/16  
For all mesial surfaces of the bicuspids and molars.
- Gracey #13/14 & 17/18  
For all distal surfaces of the bicuspids and molars.

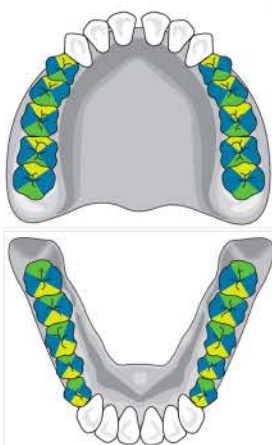
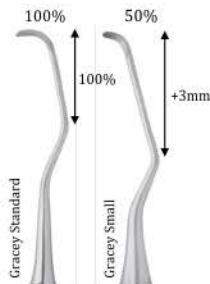
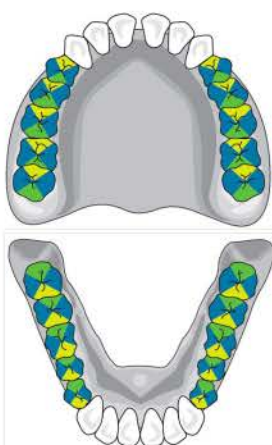

**Article# W11-302 Gracey Curettes -Small SET OF 7 PCS.**

The terminal shank of the Gracey curette Small is 3mm longer and the work endpieces are 50% shorter. This modification allows better access to the narrow root surfaces. A reduction in the widening of the gingival tissue when inserting the instrument is also an advantage of the shortened blade. Perfect for the front tooth region and for better access to all mesial and distal surfaces.



Кюрети  
Curetas  
Küretten

Кюрети  
Curette  
کرتس

**W11-227 Gracey Mini Five Set of 6 Pcs**

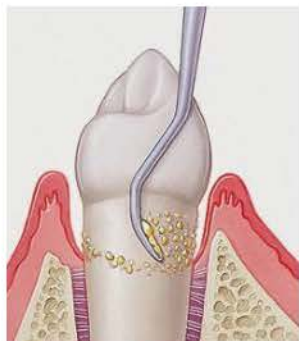

**Article# W11-228 Gracey 1/2**



**Article# W11-229 Gracey 3/4**



**Article# W11-230 Gracey 5/6**



**Article# W11-231 Gracey 7/8**



**Article# W11-232 Gracey 11/12**



**Article# W11-233 Gracey 13/14**



**Article# W11-234 Gracey After Five Set of 6 Pcs**



**Article# W11-235 Gracey 1/2 AF**



**Article# W11-236 Gracey 3/4 AF**



**Article# W11-237 Gracey 5/6 AF**



**Article# W11-238 Gracey 7/8 AF**



**Article# W11-239 Gracey 11/12 AF**



**Article# W11-240 Gracey 13/14 AF**



**SCALING AND ROOT PLANING**



Scaling removes plaque and tartar from below the gumline. Root planing smooths the tooth root and helps the gums reattach to the tooth.

**H6/H7 Hygienist Anterior Sickle Scaler**

Super-thin, contra-angle design.  
 Very effective for interproximal areas.  
 Shank angulation provides accessibility to all anterior and premolar surfaces.  
 Made with stronger and longer-lasting Stainless Steel

**7/8 Younger Good Universal Curette**

Blade designed with two cutting edges and a rounded toe for use on all surfaces.  
 Particularly use for the removal of supragingival / subgingival calculus.  
 Stainless steel  
 Completely sterilizable  
 Super-durable to stay sharper longer.

**13/14 Columbia Universal Curette DE**

Anterior Columbia Universal Curette blade designed with two cutting edges and a rounded toe for use on all surfaces.  
 Use for all side teeth and anterior tooth area.  
 Made from surgical grade stainless steel.  
 Large diameter handle design, 9.5mm  
 Completely sterilizable  
 Super-durable to stay sharper longer.

**4R/4L Columbia Universal Curette DE**

Posterior Columbia Universal Curette blade designed with two cutting edges and a rounded toe for use on all surfaces.  
 Use for the side tooth area.  
 Made from surgical grade stainless steel.  
 Large diameter handle design, 9.5mm  
 Completely sterilizable  
 Super-durable to stay sharper longer.

**2R/2L Columbia Universal Curette DE**

Anterior Columbia Universal Curette blade designed with two cutting edges and a rounded toe for use on all surfaces.  
 Use for the anterior tooth area.  
 Made from surgical grade stainless steel.  
 Large diameter handle design, 9.5mm  
 Completely sterilizable  
 Super-durable to stay sharper longer.

**GF-3 Goldman-Fox Curette, DE**

Super-thin, contra-angle design.  
 Same blade surface as GF-2.  
 Specifically designed for the proximal surface of the posterior teeth  
 Made with stronger and longer-lasting Stainless Steel

**PR1/2 Prichard Periodontal Surgical Curette, DE**

The Prichard Surgical Curette is a larger and heavier curette for the removal of granulation tissue and tenacious sub gingival deposits. Curette is 7.5" long with 1.5mm wide working ends with a 45 degree angle.

Made from surgical grade stainless steel for longevity and corrosion resistance.  
 Features a large diameter Satin Steel handle for a more comfortable, controlled grip.

**CURETTES**

Article# WI1-241



Article# WI1-242 H6/H7 Hygienist, Anterior Sickle Scaler, DE



Article# WI1-243 7/8 Younger Good Universal Curette, DE



Article# WI1-244 13/14 Columbia Universal Curette DE



Article# WI1-245 4R/4L Columbia Universal Curette DE



Article# WI1-246 2R/2L Columbia Universal Curette DE



Article# WI1-247 GF-3 Goldman-Fox Curette, DE



Article# WI1-248 PR1/2 Prichard periodontal Surgical Curette, DE

DIAGNOSTIC, PERIODONTAL

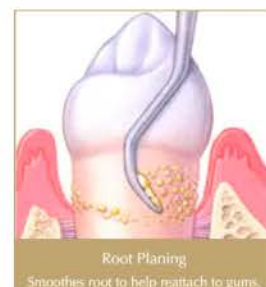

**Langer Universal Curettes**

The Langer Curette design combines the benefits of a Universal Curette blade, and the shank designs of area specific Curettes. A Universal blade allows Instrumentation on both the Mesial and Distal surfaces with one Instrument. The Gracey Style shanks allow adaptation on difficult Posterior Root surfaces. Suitable for scaling and Root planning and Periodontal Surgery. Langer Curettes have a thicker shank diameter that provides greater rigidity for Heavy calculus removal. Made from surgical grade stainless steel. Large diameter handle design, 9.5mm Completely sterilizable Super-durable to stay sharper longer.



**McCall Universal Curettes**

Pointed McCall Curette designed for the removal of supragingival calculus. McCall scalers have tapered, pointed working ends and are highly suitable for interdental cavities. Made from surgical grade stainless steel. Large diameter handle design, 9.5mm. Completely sterilizable. Super-durable to stay sharper longer.



Кюрети    Кюрети  
Curetas   Curette  
Küretten   کرتس



**QUALITY INNOVATION**

**DIAGNOSTIC, PERIODONTAL**



**Article# W11-256** 1/2 Barnhart (shown)



**Article# W11-257** 5/6 Barnhart (shown)



**Article# W11-258** IU13/14 Indiana University Anterior



**Article# W11-259** IU13/14 Indiana University



**Article# W11-260** 204S For posterior supra-gingival interproximal scaling



**Article# W11-261** 30/33 Jacquette



**Article# W11-262** 31/32 Jacquette



**Article# W11-263** 34/35 Jacquette



**Article# W11-264** H3/H4 Jacquette



**Article# W11-265** 14/15 Posterior



**Article# W11-266** H5/33 Hygienist-Jacquette



**Article# W11-267** 6/7 Goldman



**Article# W11-268** U15/30 Towner-Jacquette



*Smile*

Our goal is provide you with a comfortable experience and a beautiful smile that you desire



Стоматологический набор скейлеров  
Instruments a detartrer  
Zahnreiniger

Стоматологічний набір скейлерів  
Limpiadores de sarro  
المتسلفون



EASY TO USE THIS PRODUCT



HEALTHY GUMS & TOOTH

GINGIVITIS

PERIODONTITIS

ADVANCED PERIODONTITIS



Scaling at and just below the gumline reaches tartar deposits that can't be removed in an ordinary dental cleaning.

Root planing smooths rough spots on the roots where bacteria collect.

SCALERS Hollow Handle Ø 9.5 mm



Tartar Remover Instruments Hollow Handle Ø 9.5 mm

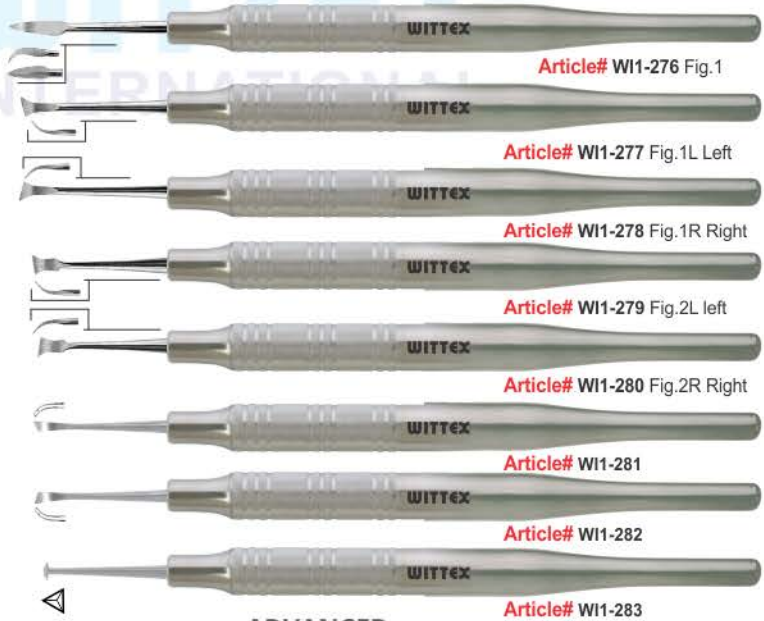

■ Кюрети    ■ Кюрети  
■ Curetas    ■ Curette  
■ Küretten    ■ کرتس

**BONE CURETTES OVAL**



Article# W11-284 Hemingway Fig.1

Article# W11-285 Hemingway Fig.2

Article# W11-286 Hemingway Fig.3

Article# W11-287 Hemingway Fig.4

Article# W11-288 Martin

Article# W11-289 Martin

Article# W11-290 Martin

**LUCAS SPOON SHAPE**



Article# W11-291 84

Article# W11-292 85

Article# W11-293 86

Article# W11-294 87

Article# W11-295 88

Article# W11-296 85/86 Lucas Surgical Curette

Article# W11-297 86/87 Lucas Surgical Curette

Article# W11-298 Lucas

Article# W11-299 Lucas

DIAGNOSTIC, PERIODONTAL

🇷🇺 Инструменты пародонтологические  
🇫🇷 Instruments pour la parodontologie  
🇩🇪 Instrumente für die Parodontologie

🇺🇦 Інструменти пародонтологічні  
🇪🇸 instrumentos para periodoncia  
🇸🇦 الصكوك اللثة

**Article# W11-300 Sugarman File Set OF 4 PCS**



**Article# W11-301** 9/10 Schluger Curved File

**Article# W11-302** 11/12 Buck Straight File

**Article# W11-303** 1S/2S Sugarman File

**Article# W11-304** 3S/4S Sugarman File



**QUALITY INNOVATION**

**Article# W11-305 Excellent to remove and to crush strong calculus deposits SET OF 3 PCS.**



**Article# W11-306** 3-7 Hirschfeld

**Article# W11-307** 5-11 Hirschfeld

**Article# W11-308** 9-10 Hirschfeld

**Article# W11-309 Gingival Retractors SET OF 3 PCS.**



**Article# W11-310**

**Article# W11-311**

**Article# W11-312**

DIAGNOSTIC, PERIODONTAL

■ Инструменты пародонтологические  
■ Instruments pour la parodontologie  
■ Instrumente für die Parodontologie

■ Інструменти пародонтологічні  
■ instrumentos para periodoncía  
■ الصكوك اللثة

**PERIODONTAL KNIVES**

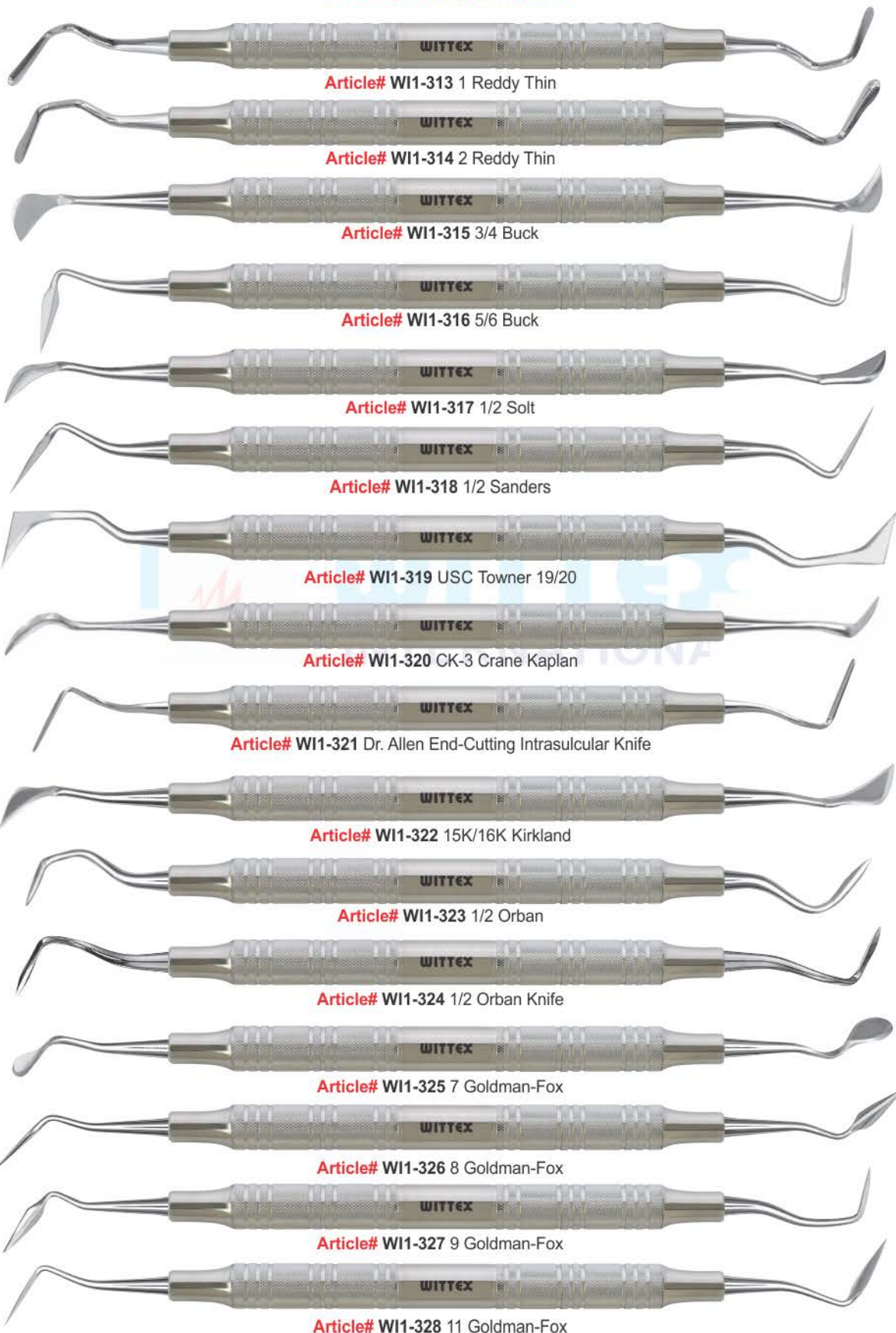

**Article# WI1-313 1 Reddy Thin**

**Article# WI1-314 2 Reddy Thin**

**Article# WI1-315 3/4 Buck**

**Article# WI1-316 5/6 Buck**

**Article# WI1-317 1/2 Solt**

**Article# WI1-318 1/2 Sanders**

**Article# WI1-319 USC Towner 19/20**

**Article# WI1-320 CK-3 Crane Kaplan**

**Article# WI1-321 Dr. Allen End-Cutting Intrасulcular Knife**

**Article# WI1-322 15K/16K Kirkland**

**Article# WI1-323 1/2 Orban**

**Article# WI1-324 1/2 Orban Knife**

**Article# WI1-325 7 Goldman-Fox**

**Article# WI1-326 8 Goldman-Fox**

**Article# WI1-327 9 Goldman-Fox**

**Article# WI1-328 11 Goldman-Fox**

- 
- 
- 
- 

PERIODONTAL CHISELS



Article# WI1-329 1/2 Kramer-Nevis

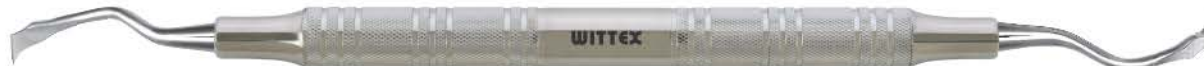

Article# WI1-330 36/37 Rhodes Back-Action



Article# WI1-331 44/45 Remington Hoe



Article# WI1-332 TG



Article# WI1-333 TG-0 Modified TG with Ochsendein cutouts



Article# WI1-334 3/4 Solt



Article# WI1-335 13K/TG



Article# WI1-336 13K/13KL

Best Ways  
To Keep  
Your Teeth  
and Gum  
Healthy



FEDI



Article# WI1-337 1 Fedi



Article# WI1-338 2 Fedi



Article# WI1-339 3 Fedi



Article# WI1-340 4 Fedi

- 
- 
- 

**PERIOSTEALS ELEVATORS**

Immediate Dentoalveolar Restoration (IDR) Kit

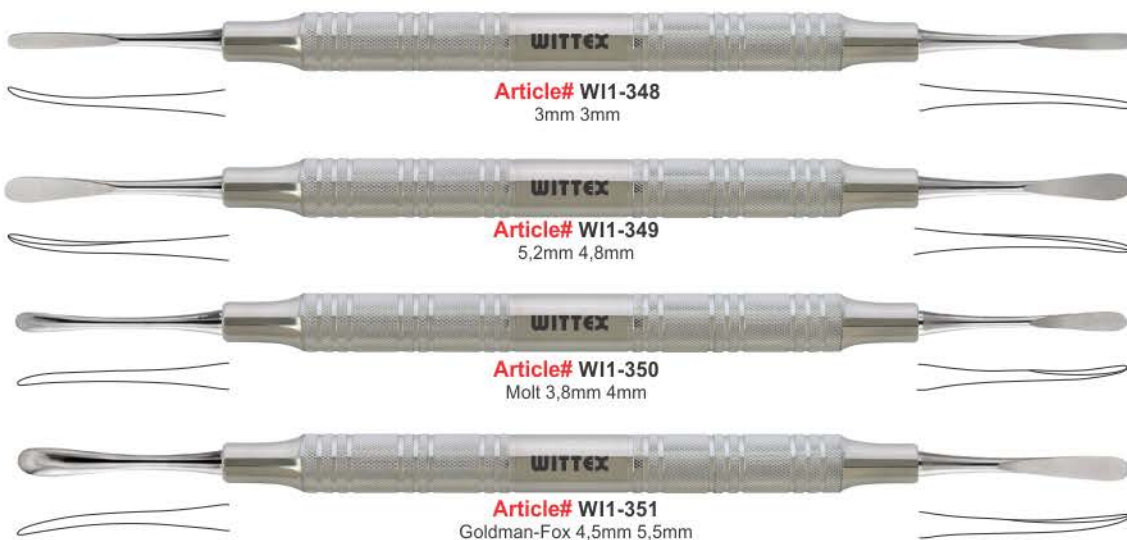
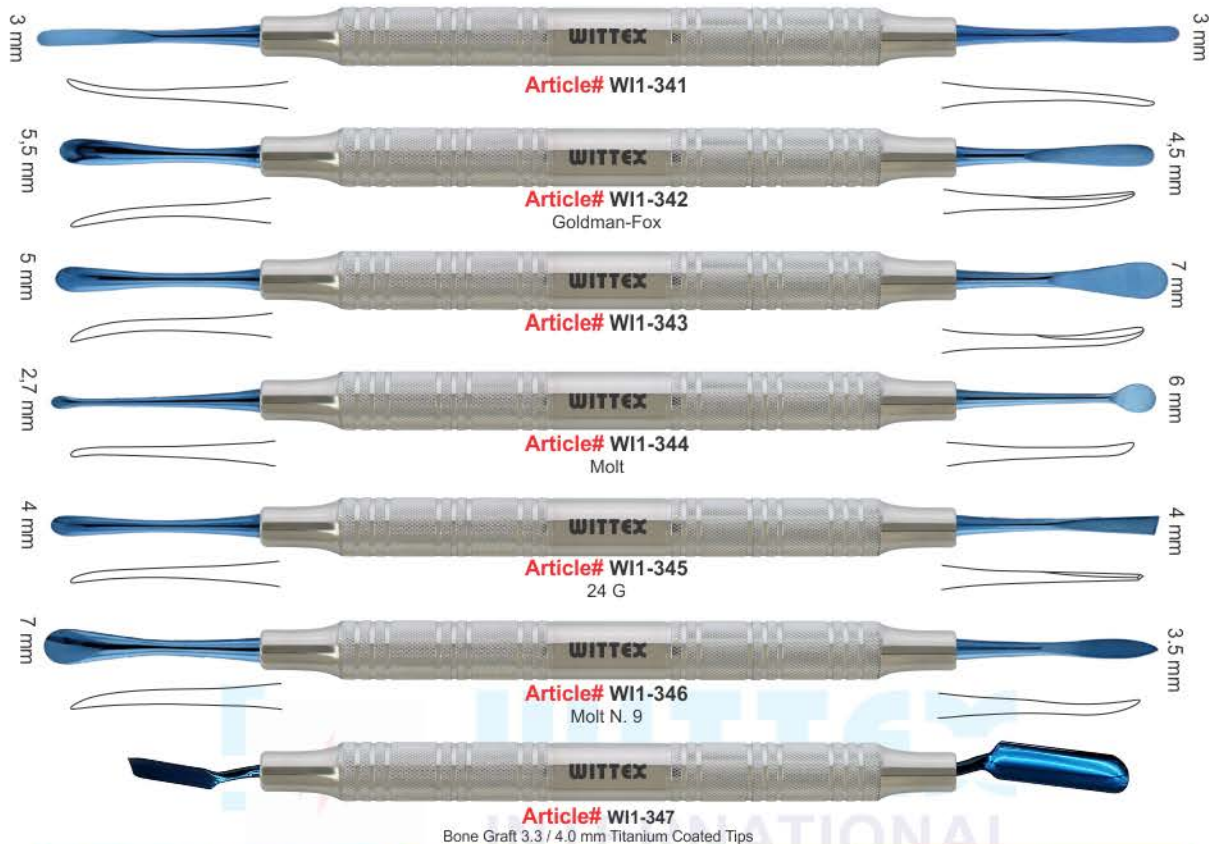

**PERIODONTAL  
SECTION 1**

- Инструменты пародонтологические
 ■ Инструменти пародонтологічні
- Instruments pour la parodontologie
 ■ instrumentos para periodoncía
- Instrumente für die Parodontologie
 ■ الصكوك اللثة



DIAGNOSTIC, PERIODONTAL

Инструменты пародонтологические  
 Instruments pour la parodontologie  
 Instrumente für die Parodontologie

Инструменти пародонтологічні  
 instrumentos para periodoncia  
 الصكوك اللثة



Article# W11-364 Prichard Periosteal



Article# W11-365 Prichard Periosteal



Article# W11-366 Prichard Periosteal



Article# W11-367 Prichard Periosteal



perio knife



Article# W11-368 Tunnelling Knife



Article# W11-369 Tunnelling Knife



Article# W11-370 Tunnelling Knife



Article# W11-371 Tunnelling Knife



Article# W11-372 Desmotome straight



Article# W11-373 Desmotome Mesial



Article# W11-374 Desmotome Distal

Инструменты пародонтологические  
 Instruments pour la parodontologie  
 Instrumente für die Parodontologie

Инструменти пародонтологічні  
 instrumentos para periodoncia  
 الصكوك اللثة

OCHSENBEIN

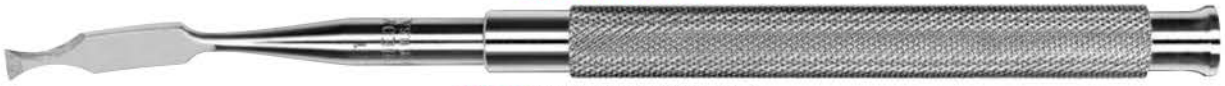

Article# W11-375 1 Ochsenbein

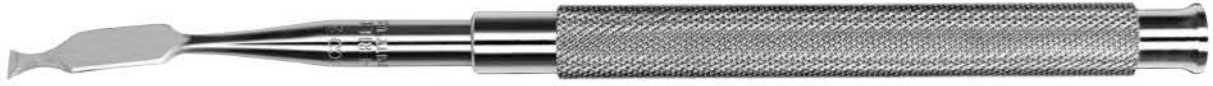

Article# W11-376 2 Ochsenbein



Article# W11-377 3 Ochsenbein



Article# W11-378 3 Ochsenbein



*Smile*

DIAGNOSTIC, PERIODONTAL



Set of 4 Straight chisels 2mm thick

Set of 4 Curved chisels 2mm thick



Teflon Point Head Mallet



Article# W11-380

Article# W11-379 4 Ochsenbein

Инструменты пародонтологические  
 Instruments pour la parodontologie  
 Instrumente für die Parodontologie

Инструменти пародонтологічні  
 instrumentos para periodoncia  
 الصكوك اللثة

OCHSENBEIN



Article# W11-381 SURGICAL BONE FILES-MILLER Bf45



Article# W11-382 SURGICAL BONE FILES-MILLER Bf1X



Article# W11-383 SURGICAL BONE FILES-MILLER Bf3X



Article# W11-384 SURGICAL BONE FILES-MILLER Bf21



Article# W11-385  
 Kramer-Nevins  
 Bone Chisel



Article# W11-386  
 Kramer-Nevins  
 Bone Chisel



ø 28 mm  
 Teflon  
 interchangeable  
 inserts  
 Autoclavable.

Article# W11-387  
 Mead 19cm



ø 26 mm  
 With  
 interchangeable  
 inserts  
 320 gr – 11 ¼ oz

Article# W11-388  
 Mead 17cm



ø 22 mm  
 Lead filled  
 200 gr – 7 oz

Article# W11-389  
 Partson 18cm

- |  |   |
|--|---|
|  Кюрети   |  Кюрети  |
|  Curetas  |  Curette |
|  Kuretten |  کورتس   |

**FD1-483 Gracey Curettes Set of 7 Pices**

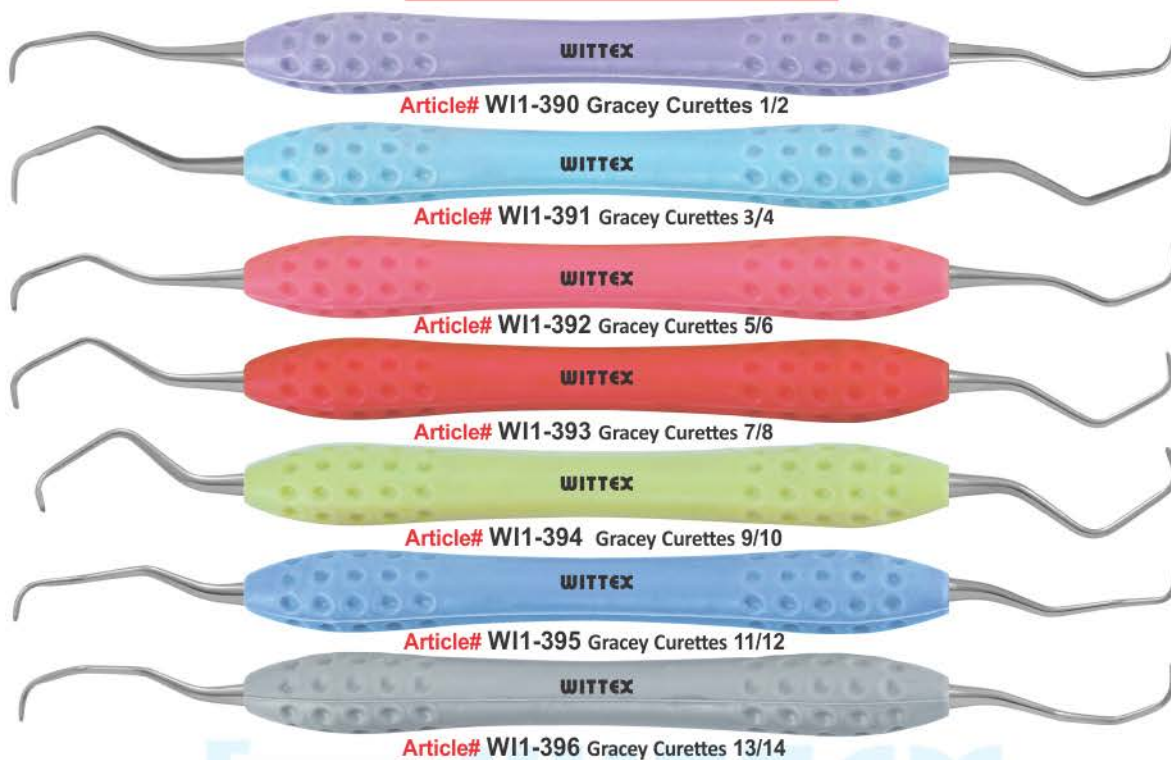

**Gracey Curettes Set of 7 Pices**

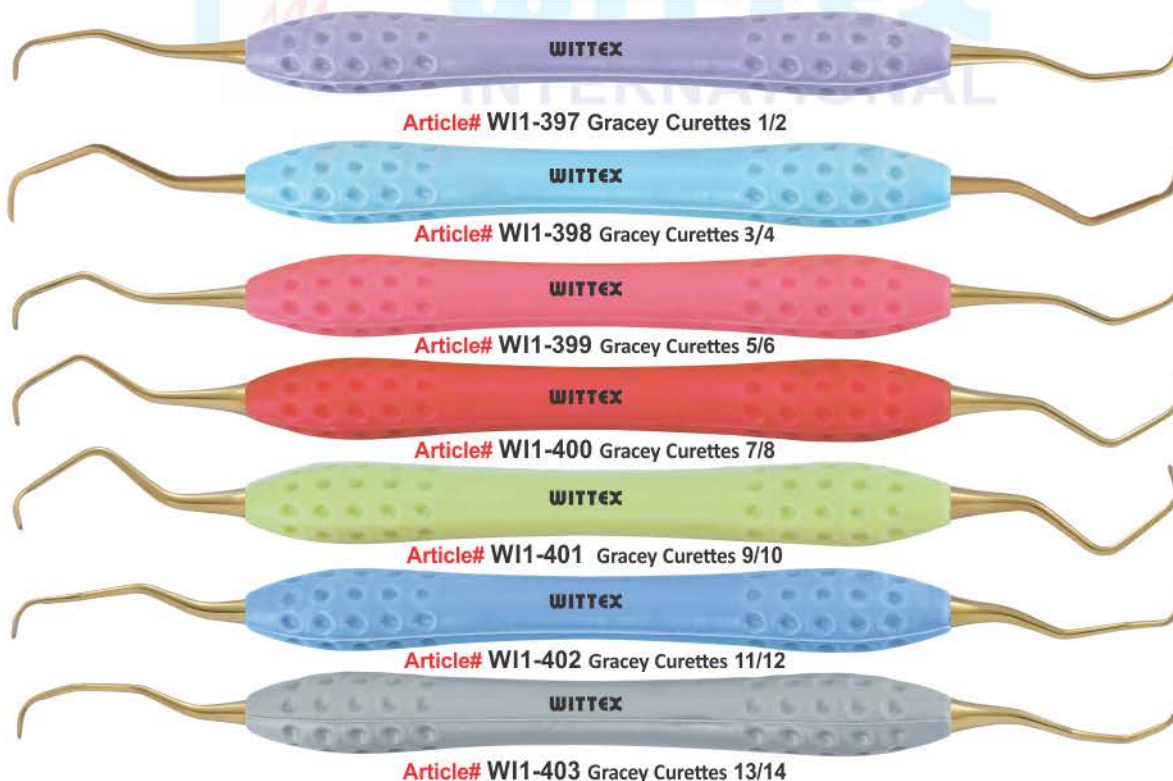

DIAGNOSTIC, PERIODONTAL

■ Кюрети    ■ Кюрети  
■ Curetas    ■ Curette  
■ Kùretten    ■ كرتس

**W11-404 GRACEY MINI FIVE SET OF 6 PCS**

Hollow Handle 9.5mm, Length 170mm Ceramic Coated Handle

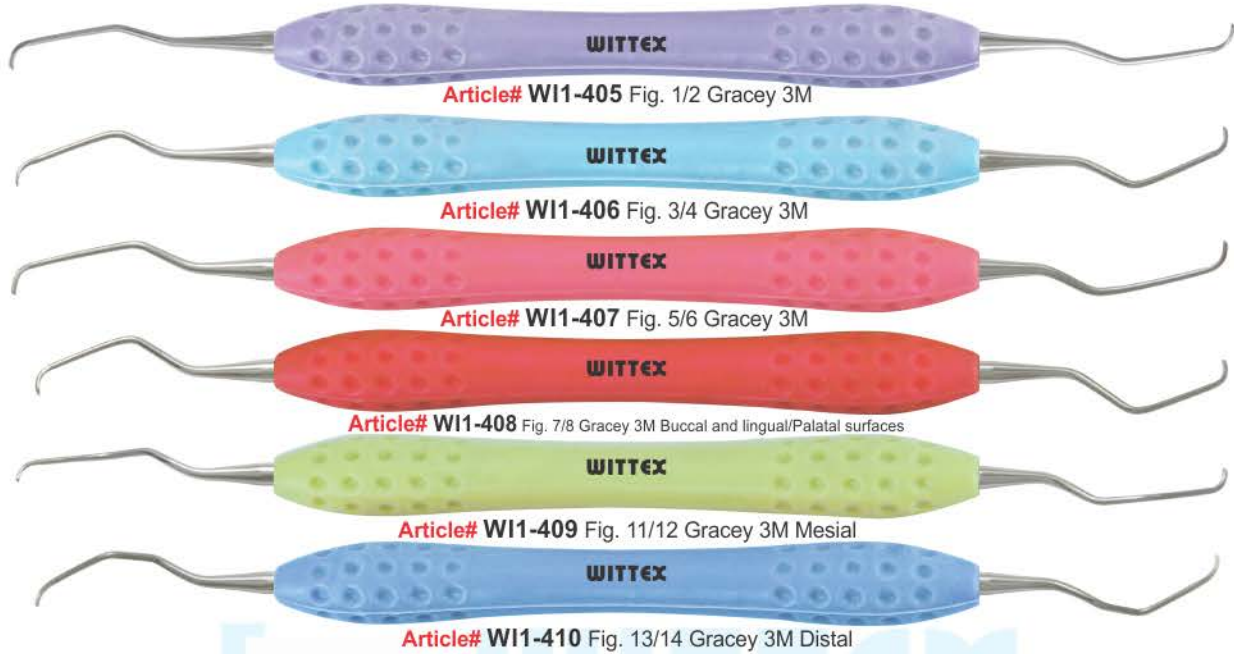

Article# W11-405 Fig. 1/2 Gracey 3M

Article# W11-406 Fig. 3/4 Gracey 3M

Article# W11-407 Fig. 5/6 Gracey 3M

Article# W11-408 Fig. 7/8 Gracey 3M Buccal and lingual/Palatal surfaces

Article# W11-409 Fig. 11/12 Gracey 3M Mesial

Article# W11-410 Fig. 13/14 Gracey 3M Distal

**Article# W11-411 GRACEY AFTER FIVE SET OF 6 PCS.**

Hollow Handle 9.5mm, Length 170mm Ceramic Coated Handle

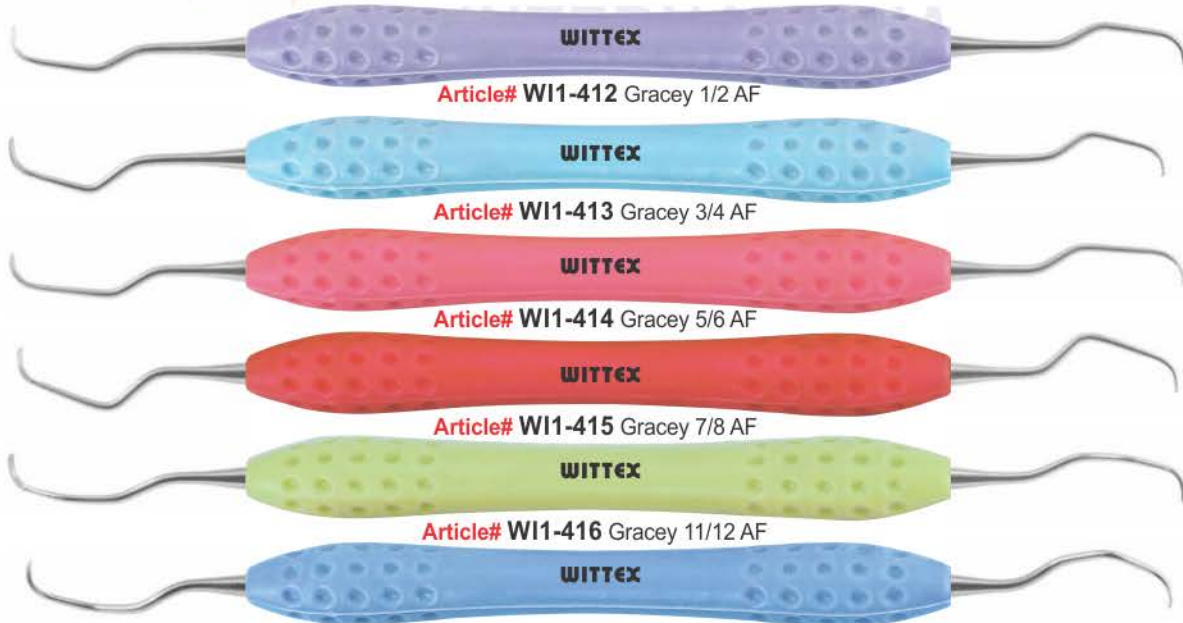

Article# W11-412 Gracey 1/2 AF

Article# W11-413 Gracey 3/4 AF

Article# W11-414 Gracey 5/6 AF

Article# W11-415 Gracey 7/8 AF

Article# W11-416 Gracey 11/12 AF

Article# W11-417 Gracey 13/14 AF

DIAGNOSTIC, PERIODONTAL



■ Кюрети    ■ Кюрети  
■ Curetas    ■ Curette  
■ Küretten    ■ كرتس

Gracey Curettes

3...1	1...3
3...1	1...3

**Article# W11-418** Fig. 1/2 GR - Gracey  
 Buccal surfaces

5...1	1...5
5...1	1...5

**Article# W11-419** Fig. 3/4 GR - Gracey  
 Lingual/Palatal surfaces

5...1	1...5
5...1	1...5

**Article# W11-420** Fig. 5/6 GR - Gracey

8...4	4...8
8...4	4...8

**Article# W11-421** Fig. 7/8 GR - Gracey  
 Buccal and lingual/  
 palatal surfaces

8...4	4...8
8...4	4...8

**Article# W11-422** Fig. 9/10 GR - Gracey  
 Buccal and lingual/  
 palatal surfaces more angled

8...4	4...8
8...4	4...8

**Article# W11-423** Fig. 11/12 GR - Gracey  
 Mesial

8...4	4...8
8...4	4...8

**Article# W11-424** Fig. 13/14 GR - Gracey  
 Distal

8...4	4...8
8...4	4...8

**Article# W11-425** Fig. 15/16 GR - Gracey  
 Mesial

8...4	4...8
8...4	4...8

**Article# W11-426** Fig. 17/18 GR - Gracey  
 Distal

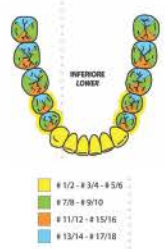
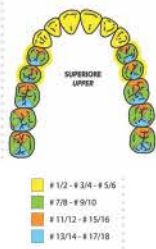

DIAGNOSTIC, PERIODONTAL

Стоматологический набор скейлеров  
Instruments a detartrer  
Zahnreiniger

Стоматологічний набір скейлерів  
Limpiadores de sarro  
المستلفون

Sickle Scalars



Article# WI1-427 Fig. U15/33 - Towner-Jaquette



Article# WI1-428 Fig. U15/30 - Towner-Jaquette



Article# WI1-429 Fig. H5/33



Article# WI1-430 Fig. H6/H7



Article# WI1-431 Fig. 30/33 - Jaquette



Article# WI1-432 Fig. T2/T3 - Taylor



Article# WI1-433 Fig. 204



Article# WI1-434 Fig. 204S



Article# WI1-435 Fig. 11/12 - MC - McCall Mesial



Article# WI1-436 Fig. 13/14 - MC - McCall Distal

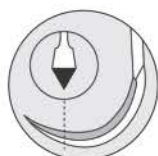
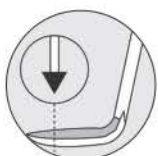

**Straight and curved sickle scalars**  
Feature: 2 cutting edges curved facial component tipped ends

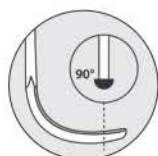

**Universal curettes**  
are characterized by an angle of 90° between the terminal stem and the cutting component.

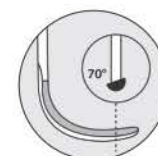

**Gracey curettes**  
are characterized by an angle of 70° between the terminal stem and the cutting component.

 Кюрети	 Кюрети
 Curetas	 Curette
 Küretten	 کرتس

**Universal Curettes**



**Article# WI1-437** Fig. 13S/14S - MC - McCall



**Article# WI1-438** Fig. 17S/18S - MC - McCall  
Distal



**Article# WI1-439** Fig. M23



**Article# WI1-440** Fig. 204SD



**Article# WI1-441** Fig. YG7/8-Younger Good



**Article# WI1-442** Fig. L 1/2 - Langer



**Article# WI1-443** Fig. L 3/4 - Langer



**Article# WI1-444** Fig. L 5/6 - Langer



**Article# WI1-445** Fig. M 23A



**Article# WI1-446** Fig. M 23B

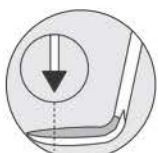

**Straight and curved sickle scalers**

Feature: 2 cutting edges curved facial component tipped ends

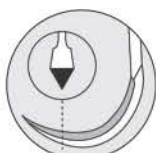

**Universal curettes**

are characterized by an angle of 90° between the terminal stem and the cutting component.

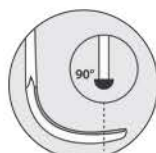

**Gracey curettes**

are characterized by an angle of 70° between the terminal stem and the cutting component.

**Dental Hand Instruments**

The types of hand instruments can be categorized based on their function:

Examining the mouth and teeth  
 Scaling or professional cleaning of teeth  
 Cutting teeth and removing cavities  
 Placing and condensing filling materials  
 Carving and finishing dental fillings  
 Miscellaneous types  
 Instruments used for examining the mouth and teeth

Mouth mirrors are used to examine the condition of the teeth and mouth, as well as to retract the tongue and cheeks upon examination. Probes— There are many probes available but the main types are the straight probe, Briault probe and periodontal probe.

The straight probe is sharp and it is used to examine cavities in the dentine region as well as to check the margins of restorations or fillings. The Briault probe is also sharp and it is used to detect the junction between the enamel and dentine. Briault can also be used to detect tartar hidden in the gum pockets.

A periodontal probe can be used to measure the depth of the gum pockets and for other measurements. Instruments for cutting and scraping tissues and deposits

Scalers remove tartar (calculus) on the tooth surface as well as those hidden in the gum pockets. They can also be used to remove other surface deposits and temporary crowns.

Excavators are used to remove softened dentine and temporary fillings. The back of the blade can also be used for placing linings between filling materials. Sometimes excavators can be used for carving metal or amalgam fillings. Chisels are used to remove unsupported enamel during cavity preparation. Unsupported enamel can be harmful for it can compromise the longevity of the filling if not removed. Hatchets and hoes have similar purposes to chisels. Instruments used for placing and condensing filling materials Plastic instruments convey and shape filling materials and are usually flat blades that do not use heavy pressure.

Some instruments have rounded ends for shaping and burnishing the surfaces of fillings. Plastic instruments are usually made of stainless steel for most materials though there are also thin Teflon-coated or titanium nitride instruments which are non-stick for composite fillings. Condensers or pluggers are used for compressing and forming filling materials. Heavy pressure is applied on use therefore these instruments are usually used for metal or amalgam fillings. Instruments used for carving and finishing fillings Carving and finishing instruments have sharp or semi-sharp blades of various shapes. They are used to carve materials by cutting and scraping.



Here we have a cavity that has destroyed a part of the tooth.

The cavity is removed with a drill and the site is prepared. Note that this preparation is smaller than the other methods of tooth restoration.

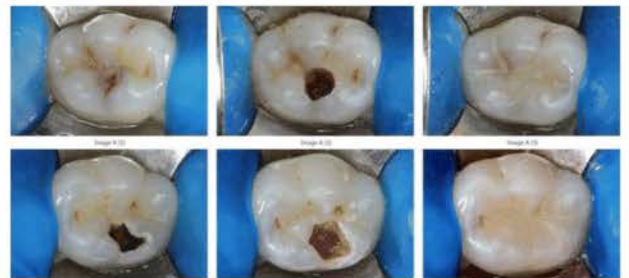

*Your Smile is our Priority*



DIAGNOSTIC, PERIODONTAL



- Инструменты для реставрации
- Instruments pour plombage
- Füllungsinstrumente (mit Kontrawinkel)
- Инструменти для реставрації
- Instrumentos para obturaciones
- ملء الصكوك

**Article# W12-01 COMPOSITE SPATULA SET OF 4 PCS**



**Article# W12-02** Composite spatula, fine, 1.7 / 0.9 mm rigid



**Article# W12-03** Composite spatula, 1.4 / 1.4mm rigid



**Article# W12-04** Heidemann Fig. 1 composite spatula, 1.6 / 1.5mm, flexible



**Article# W12-05** Heidemann Fig. 1 composite spatula, 2.2 / 2.2mm, flexible



**Article# W12-06 COMPOSITE SPATULA SET OF 4 PCS**



**Article# W12-07**



**Article# W12-08**



**Article# W12-09**

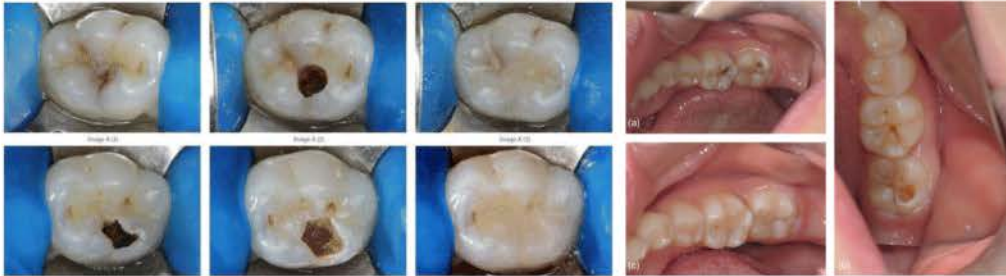

**Article# W12-10 COMPOSITE SPATULA SET OF 3 PCS**



**Article# W12-11** Spatula, 2.0 / 2.0mm



**Article# W12-12** Spatula, 2.5 / 2.5mm



**Article# W12-13** Williams Spatula, 3.2 / 3.2mm

RESTORATIVE INSTRUMENTS

- 
- 

W12-14 FILLING INSTRUMENTS SPATULA GOLD TIP SET OF 3 PCS



W12-18 FILLING INSTRUMENTS BALL GOLD TIP SET OF 3 PCS



Article# W12-22 Filling instrument, SET OF 3 PCS spatula



Article# W12-26 Ball Burnisher SET OF 3 PCS



RESTORATIVE INSTRUMENTS

■ Инструменты для реставрации    ■ Инструменти для реставрації  
■ Instruments pour plombage       ■ Instrumentos para obturaciones  
■ Füllungsinstrumente (mit Kontrawinkel)    ■ ملء الصكوك

Available in Hollow Handle Ø8mm - 9.5mm

**Article# W12-30 COMPOSITE GOLD TIP INSTRUMENTS SET OF 5 PCS**



**Article# W12-31 Double Paddle #1T 7 mm long/2.0 mm wide.**



**Article# W12-32 Paddle/Condenser #3T 7mm long/2mm wide with a 1.1mm**



**Article# W12-33 Double Paddle #4T 11mm long/2.0mm wide.**



**Article# W12-34 Paddle/Condenser #20T 11mm long/2mm wide with a 2.0mm**



**Article# W12-35 Paddle/Acorn #23T 11mm long/2mm wide 2.3mm diameter.**



**Article# W12-36 PLUGGER, CONDENSER & BURNISHER SET OF 6 PCS**



**Article# W12-37 Multifunction Plugger & Condenser PLGS/M Plugger Medium**



**Article# W12-38 Multifunction Plugger & Condenser PLGS/L Plugger Large**



**Article# W12-39 Universal Amalgam Kto Titanium Coated**



**Article# W12-40 B27/29 BALL BURNISHER - Titanium Coated**



**Article# W12-41 EGG Burnisher DE**



**Article# W12-42 T Ball Burnisher**

■ Инструменты для реставрации    ■ Инструменти для реставрації  
■ Instruments pour plombage    ■ Instrumentos para obturaciones  
■ Füllungsinstrumente (mit Kontrawinkel)    ■ ملء الصكوك

**Article# W12-43 Excavator Set of 4 Pices**



**Article# W12-44 Excavator D/E No. 17**



**Article# W12-45 Excavator D/E No. 18**



**Article# W12-46 Excavator D/E No. 19**



**Article# W12-47 14**



**Article# W12-48 Amalgam Plugger Set of 4 Pices**



**Article# W12-49 Amalgam Plugger Serrated**



**Article# W12-50 Amalgam Plugger Serrated**



**Article# W12-51 Amalgam Plugger Smooth**



**Article# W12-52 Amalgam Plugger Smooth**

**Article# W12-53 Ball Burnisher Set of 4 Pices**



**Article# W12-54 Hopson**



**Article# W12-55 Burnisher 1**



**Article# W12-56 Fig.6**

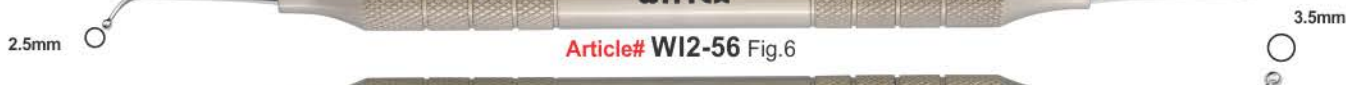

**Article# W12-57 Fig.7**

RESTORATIVE INSTRUMENTS

■ Инструменты для реставрации  
■ Instruments pour plombage  
■ Füllungsinstrumente (mit Kontrawinkel)

■ Инструменти для реставрації  
■ Instrumentos para obturaciones  
■ ملء الصكوك

**Article# WI2-58 COMPOSITE SPATULA SET OF 4 PCS**



**Article# WI2-59** Composite spatula, fine, 1.7 / 0.9 mm rigid



**Article# WI2-60** Composite spatula, 1.4 / 1.4mm rigid



**Article# WI2-61** Heidemann Fig. 1 composite spatula, 1.6 / 1.5mm, flexible



**Article# WI2-62** Heidemann Fig. 1 composite spatula, 2.2 / 2.2mm, flexible



**Article# WI2-63 COMPOSITE SPATULA SET OF 3 PCS**



**Article# WI2-64**



**Article# WI2-65**



**Article# WI2-66**

**Article# WI2-67 COMPOSITE SPATULA SET OF 3 PCS**



**Article# WI2-68** Spatula, 2.0 / 2.0mm



**Article# WI2-69** Spatula, 2.5 / 2.5mm



**Article# WI2-70** Williams Spatula, 3.2 / 3.2mm

RESTORATIVE INSTRUMENTS

Article# W12-71 FILLING INSTRUMENTS SPATULA GOLD TIP SET OF 3 PCS



Article# W12-75 FILLING INSTRUMENTS BALL GOLD TIP SET OF 3 PCS.



Article# W12-79 Filling instrument, SET OF 3 PCS spatula



Article# W12-83 Ball Burnisher SET OF 3 PCS



RESTORATIVE INSTRUMENTS

- 
- 
- 
- 

Available in Hollow Handle Ø8mm - 9.5mm

Article# W12-87 COMPOSITE GOLD TIP INSTRUMENTS SET OF 5 PCS

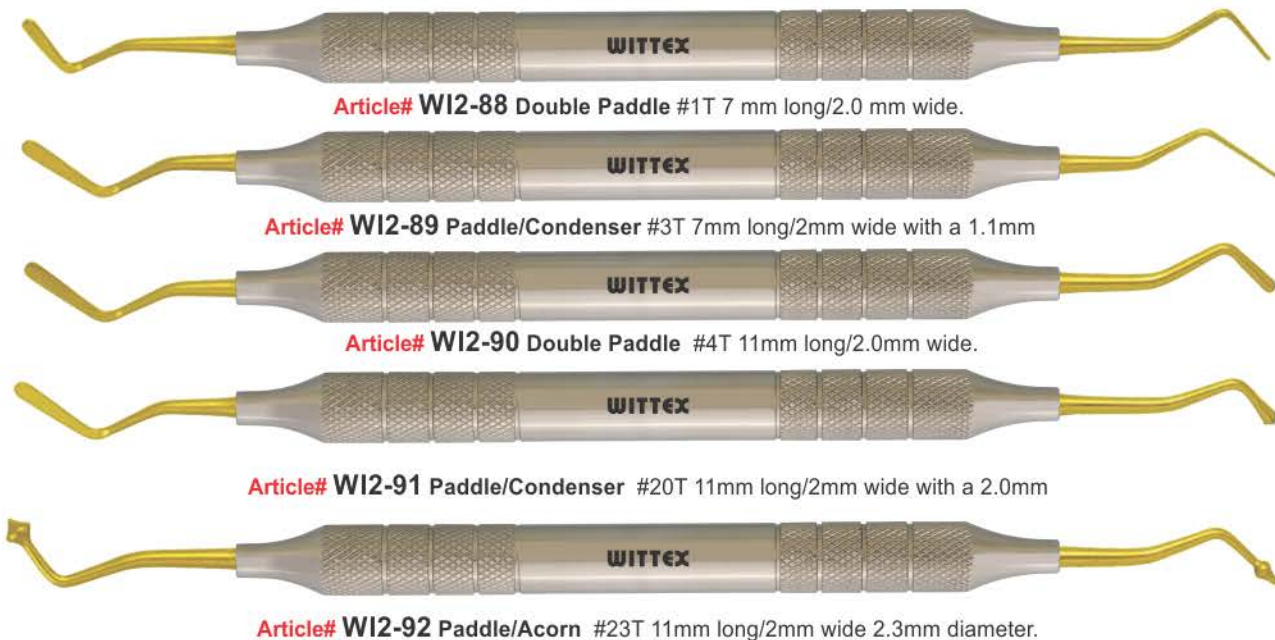

Article# W12-88 Double Paddle #1T 7 mm long/2.0 mm wide.

Article# W12-89 Paddle/Condenser #3T 7mm long/2mm wide with a 1.1mm

Article# W12-90 Double Paddle #4T 11mm long/2.0mm wide.

Article# W12-91 Paddle/Condenser #20T 11mm long/2mm wide with a 2.0mm

Article# W12-92 Paddle/Acorn #23T 11mm long/2mm wide 2.3mm diameter.

RESTORATIVE INSTRUMENTS



Article# W12-93 PLUGGER, CONDENSER & BURNISHER SET OF 6 PCS

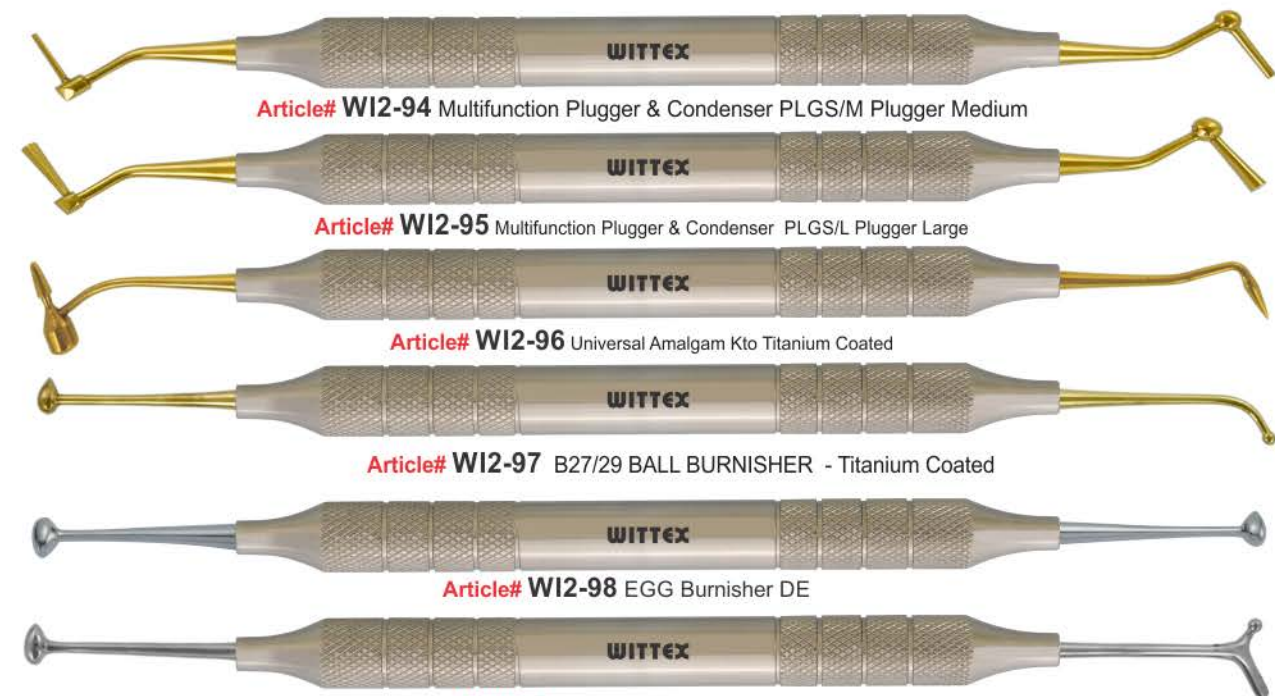

Article# W12-94 Multifunction Plugger & Condenser PLGS/M Plugger Medium

Article# W12-95 Multifunction Plugger & Condenser PLGS/L Plugger Large

Article# W12-96 Universal Amalgam Kto Titanium Coated

Article# W12-97 B27/29 BALL BURNISHER - Titanium Coated

Article# W12-98 EGG Burnisher DE

Article# W12-99 T Ball Burnisher

■ Инструменты для реставрации  
■ Instruments pour plombage  
■ Füllungsinstrumente (mit Kontrawinkel)
 ■ Инструменти для реставрації  
■ Instrumentos para obturaciones  
■ ملء الصكوك

**Article# WI2-100 Excavator Set of 4 Pices**

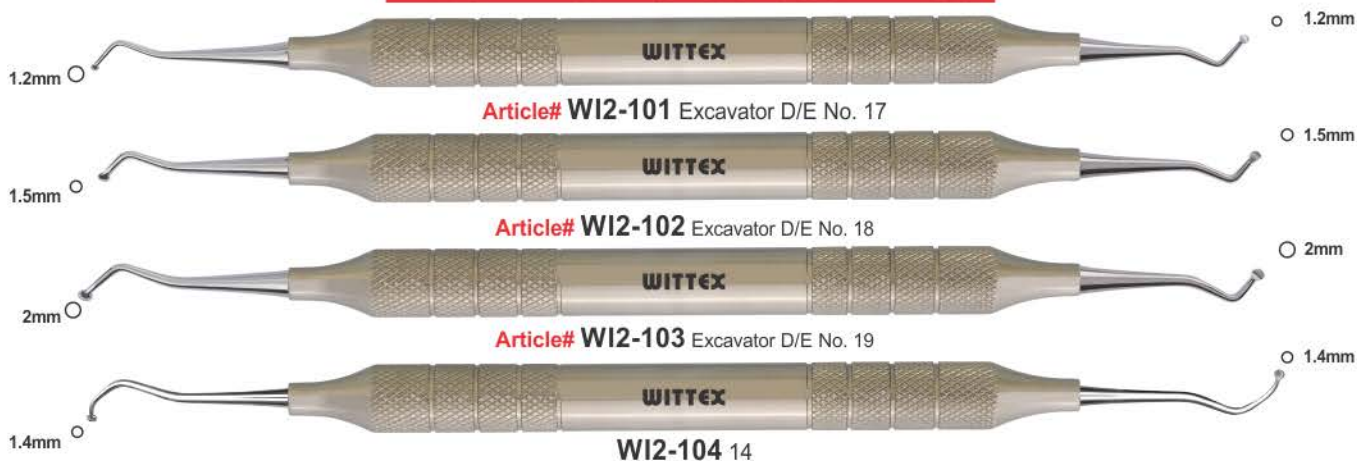

**Article# WI2-105 Amalgam Plugger Set of 4 Pices**



**Article# WI2-110 Ball Burnisher Set of 4 Pices**



RESTORATIVE INSTRUMENTS

■ Инструменты для реставрации      ■ Инструменти для реставрації  
■ Instruments pour plombage      ■ Instrumentos para obturaciones  
■ Füllungsinstrumente (mit Kontrawinkel)      ■ ملء الصكوك

**Article# W12-115 COMPOSITE GOLD TIP INSTRUMENTS SET OF 5 PCS**



**Article# W12-121 COMPOSITE GOLD TIP INSTRUMENTS SET OF 6 PCS**



**Article# W12-128 COMPOSITE GOLD TIP INSTRUMENTS SET OF 5 PCS**



- Инструменты для реставрации
- Instruments pour plombage
- Füllungsinstrumente (mit Kontrawinkel)
- Инструменти для реставрації
- Instrumentos para obturaciones
- ملء الصكوك

**Article# WI2-134 COMPOSITE GOLD TIP INSTRUMENTS SET OF 5 PCS**



**Article# WI2-140 COMPOSITE INSTRUMENTS SET OF 5 PCS**

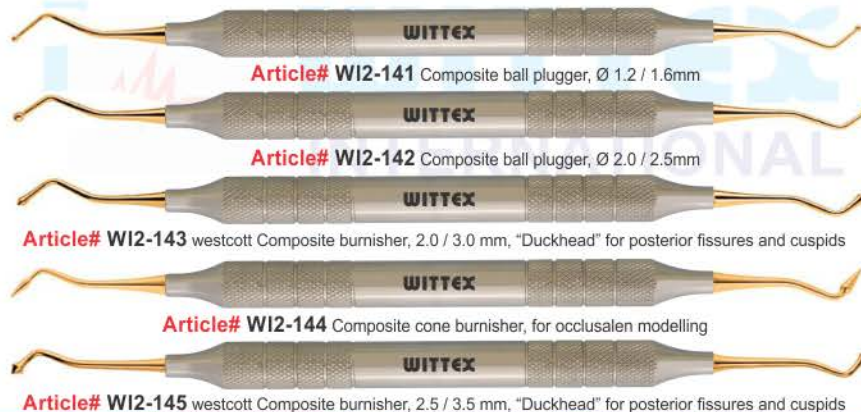

**Article# WI2-146 ANTERIOR SET OF 5 PCS**



- |  |                                  |
|--|----------------------------------|
| ■ Инструменты для реставрации            | ■ Инструменти для реставрації    |
| ■ Instruments pour plombage              | ■ Instrumentos para obturaciones |
| ■ Füllungsinstrumente (mit Kontrawinkel) | ■ ملء الصكوك                     |

**Article# W12-152 COMPOSITE FILLING INSTRUMENTS SE OF 7 PCS**



**Article# W12-160 MI1-1138 Composit Set of 5 Pcs With Gold Tips**



**Article# W12-165 Plastic Filling Instruments**



**Article# W12-166 Composit Set of 5 Pcs With Gold Tips**



- 
- Инструменты для реставрации  
 Инструменти для реставрації  
 Instruments pour plombage  
 Instrumentos para obturaciones  
 Füllungsinstrumente (mit Kontrawinkel)  
 ملء الصكوك

**Article# WI2-172 COMPOSITE GOLD TIP INSTRUMENTS SET OF 11 PCS**

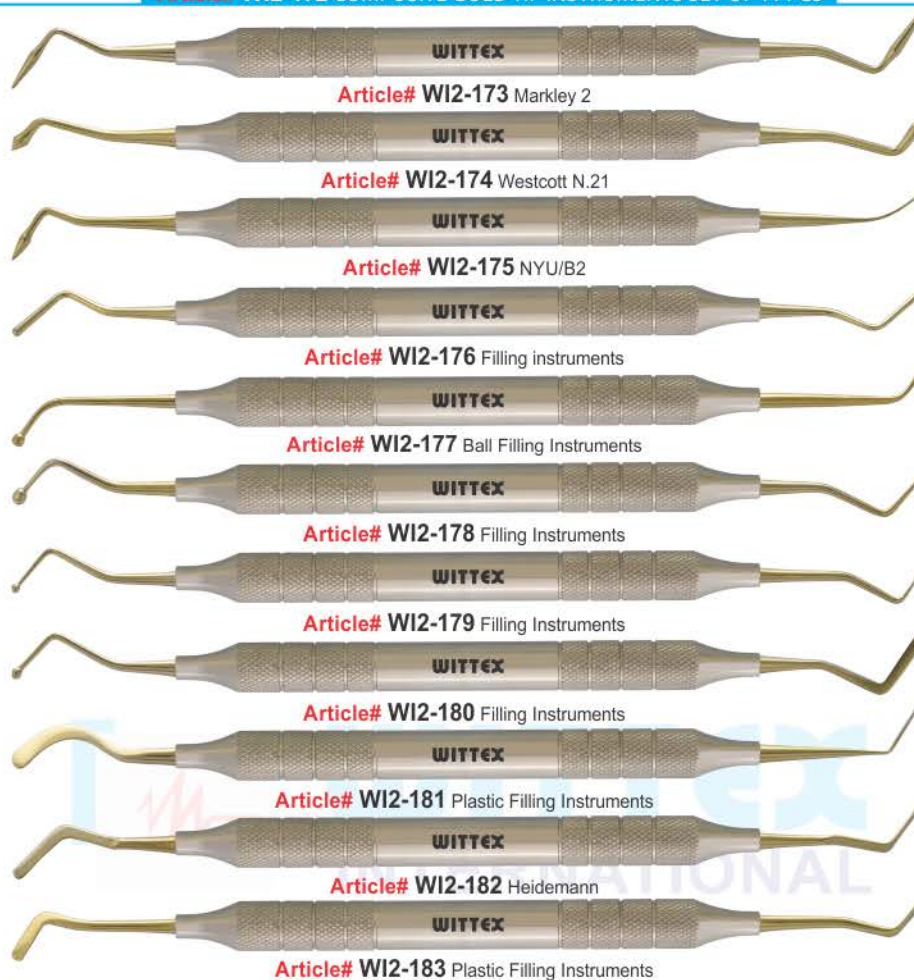

**Article# WI2-184 COMPOSITE INSTRUMENTS SET OF 5 PCS**

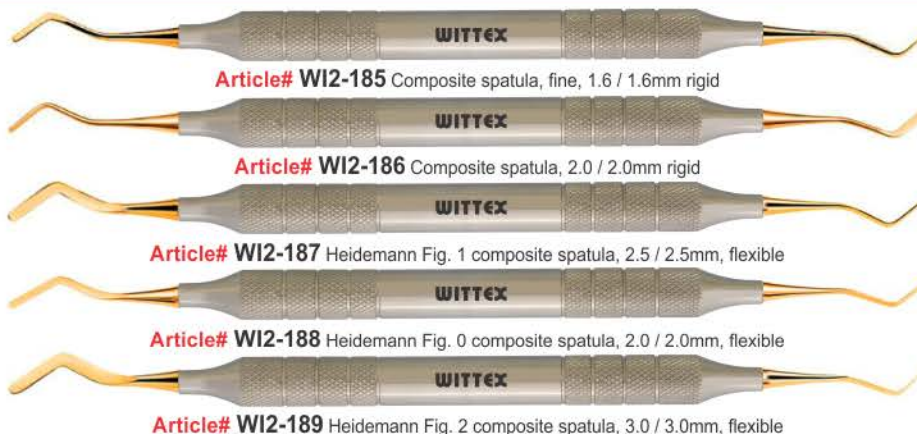

RESTORATIVE INSTRUMENTS

■ Инструменты для реставрации     ■ Инструменти для реставрації  
■ Instruments pour plombage     ■ Instrumentos para obturaciones  
■ Füllungsinstrumente (mit Kontrawinkel)     ■ ملء الصكوك

**Article# WI2-190 FILLING INSTRUMENTS SPATULA GOLD TIP SET OF 3 PCS**



**Article# WI2-194 FILLING INSTRUMENTS BALL GOLD TIP**



**Article# WI2-198 Filling instrument, set of 3 pieces spatula**



**Article# WI2-202 FILLING INSTRUMENTS BALL GOLD TIP SET OF 7 PCS**



■ Инструменты для реставрации  
■ Instruments pour plombage  
■ Füllungsinstrumente (mit Kontrawinkel)

■ Инструменти для реставрації  
■ Instrumentos para obturaciones  
■ ملء الصكوك

**Article# WI2-210 COMPOSITE FILLING INSTRUMENTS SET OF 9 PCS**

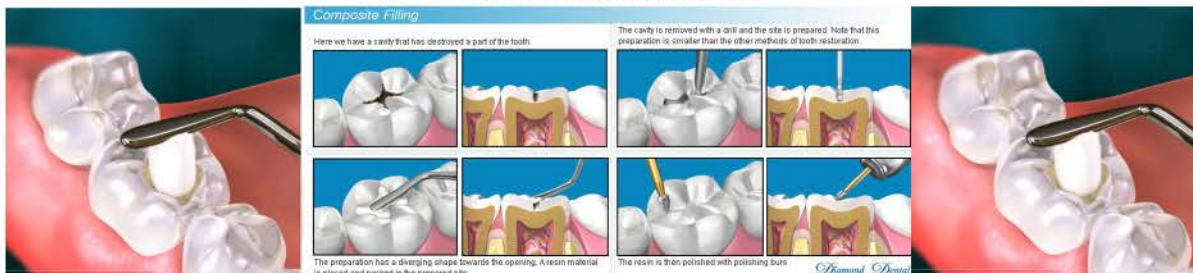
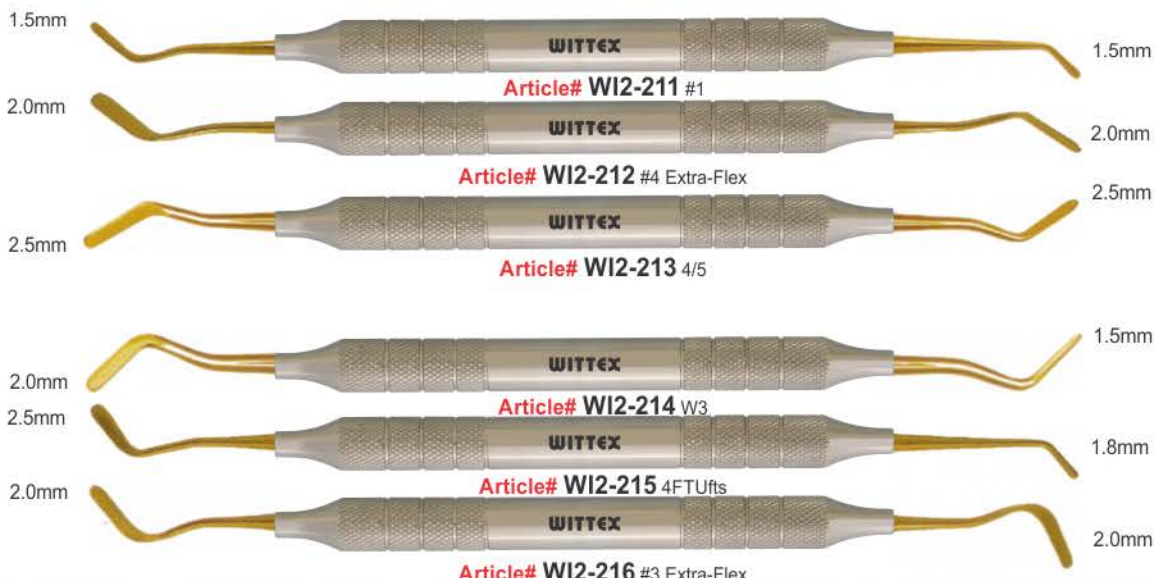

**Article# WI2-220 COMPOSITE FILLING INSTRUMENTS SET OF 6 PCS**



■ Инструменты для реставрации ■ Инструменти для реставрації  
■ Instruments pour plombage ■ Instrumentos para obturaciones  
■ Füllungsinstrumente (mit Kontrawinkel) ■ ملء الصكوك

**Article# WI2-227 COMPOSITE INSTRUMENTS SET OF 4 PCS**

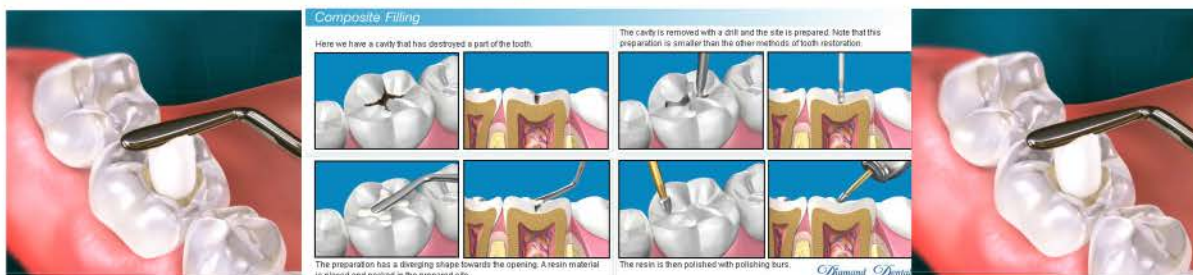
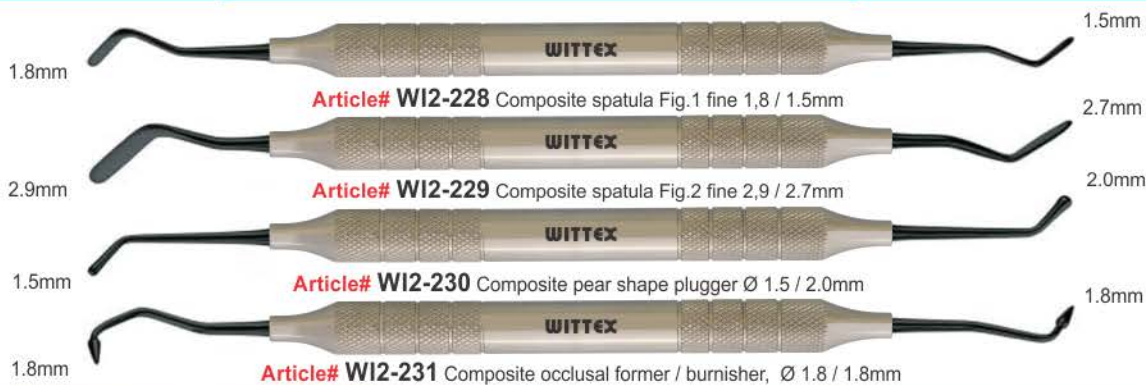

**Article# WI2-232 COMPOSITE BALL PLUGGER SET OF 4 PCS**



**Article# WI2-237 AMALGAM PLUGGER SET OF 6 PCS**



RESTORATIVE INSTRUMENTS

■ Инструменты для реставрации    ■ Инструменти для реставрації  
■ Instruments pour plombage       ■ Instrumentos para obturaciones  
■ Füllungsinstrumente (mit Kontrawinkel)    ■ ملء الصكوك

**Article# WI2-244 GINGIVAL MARGIN TRIMMERS / FILLING REMOVER SET OF 5 PCS**

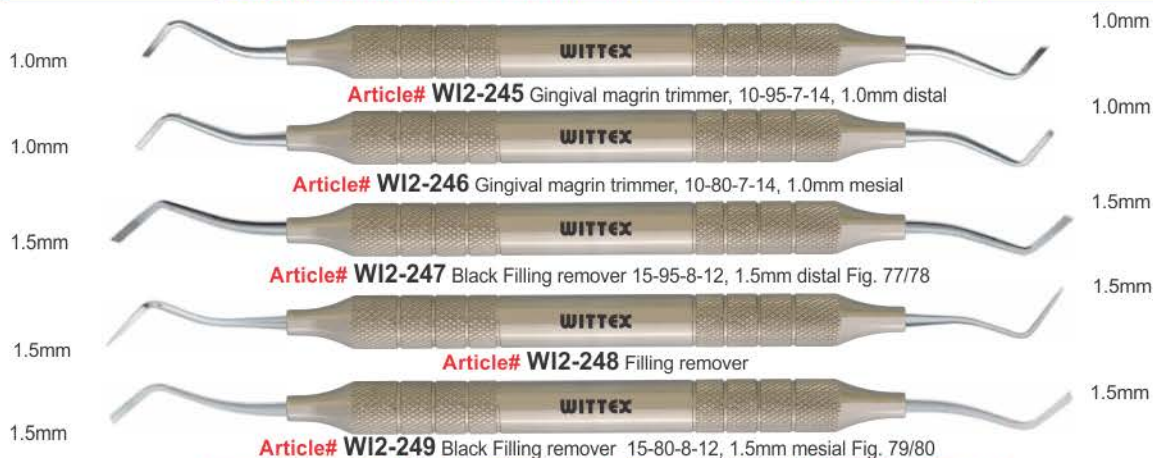

**Article# WI2-250 PLASTIC FILLING INSTRUMENTS SET OF 10 PCS**



HEIDEMANN SPATULAS

SPATULAS



RESTORATIVE INSTRUMENTS

Инструменты для реставрации

Instruments pour plombage

Füllungsinstrumente (mit Kontrawinkel)

Инструменти для реставрації

Instrumentos para obturaciones

ملء الصكوك

**RESTORATIVE INSTRUMENTS**



**RESTORATIVE PLUGGER**



🇷🇺 Инструменты для реставрации    🇺🇦 Інструменти для реставрації  
🇫🇷 Instruments pour plombage    🇩🇪 Instrumentos para obturaciones  
🇮🇹 Füllungsinstrumente (mit Kontrawinkel)    🇸🇦 ملء الصكوك



Article# WI2-289 Plugger, Ø 1.0 / 0.8mm

Article# WI2-290 Plugger, Ø 1.6 / 1.2mm

Article# WI2-291 Plugger, Ø 2.0 / 1.6mm

SPATULA / PLUGGER BURNISHER SET OF 5 PCS



Article# WI2-292 Spatula, 2.5 / 2.5mm

Article# WI2-293 Spatula, 3.2 / 3.2mm

Article# WI2-294 Spatula, 1.8 / 1.8mm

Article# WI2-295 Spatula, 1.8 / 2.0mm

Article# WI2-296 Plugger Ø 2.7 / 1.6mm



Here we have a cavity that has destroyed a part of the tooth.

The cavity is removed with a drill and the site is prepared. Note that this preparation is smaller than the other methods of tooth restoration.

The preparation has a diverging shape towards the opening. A resin material is placed and packed in the prepared site.

The resin is then polished with polishing burs.

CARVING INSTRUMENTS



Article# WI2-297 Hollenback carving instrument Fig. 3

Article# WI2-298 Hollenback Carving instrument Fig. 3S

Article# WI2-299 NYSTRÖM Carving instrument 2.3mm N1

Article# WI2-300 NYSTRÖM Carving instrument 1.8mm N3

Article# WI2-301 ward Carving instrument

Article# WI2-302 NYSTRÖM Carving instrument 2.1mm N2

Article# WI2-303 Cleoid Discoid Carving Instrument

Article# WI2-304 Frahm Carving Instrument, 45° angled

■ Инструменты для реставрации    ■ Инструменти для реставрації  
■ Instruments pour plombage    ■ Instrumentos para obturaciones  
■ Füllungsinstrumente (mit Kontrawinkel)    ■ ملء الصكوك

**COMPOSITE BURNISHER FILLING INSTRUMENTS**



Article# W12-311 PKT-3R Rounded-cone POSTERIOR



**WOODSON FILLING INSTRUMENTS**

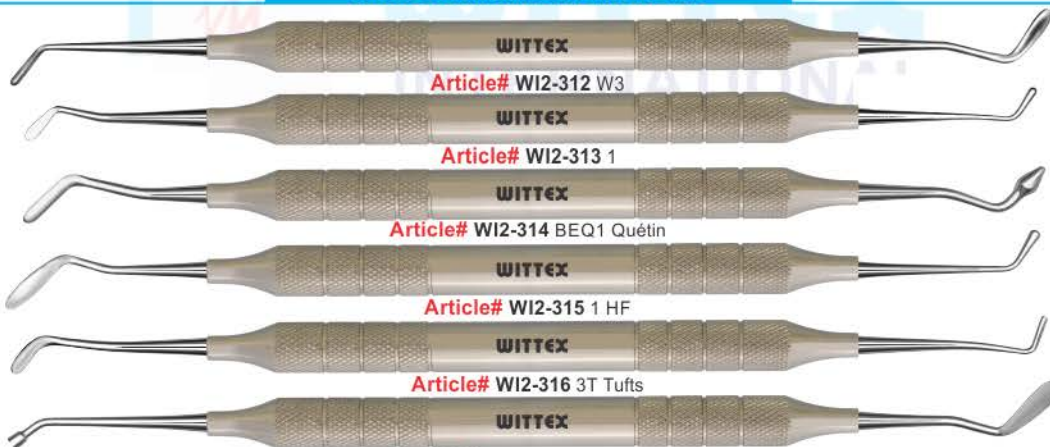

Article# W12-317 2 Woodson

**PLUGGERS/CONDENSERS BLACK & HOLLENBACK**



**MARQUETTE CONDENSER**

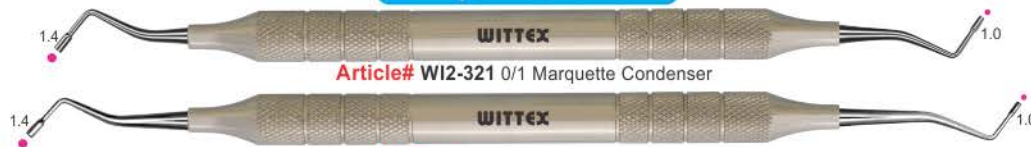

Article# W12-322 0/1 Marquette

- |  |                                  |
|--|----------------------------------|
| ■ Инструменты для реставрации            | ■ Инструменти для реставрації    |
| ■ Instruments pour plombage              | ■ Instrumentos para obturaciones |
| ■ Füllungsinstrumente (mit Kontrawinkel) | ■ ملء الصكوك                     |

**PLUGGERS/CONDENSERS BLACK & HOLLENBACK**



**MORTONSON**



**PLUGGERS/CONDENSERS**



**OREGON**



**WARD**



- 
- 

**TANNER FILLING INSTRUMENTS**



**BURNISHERS SET OF 5 PCS**

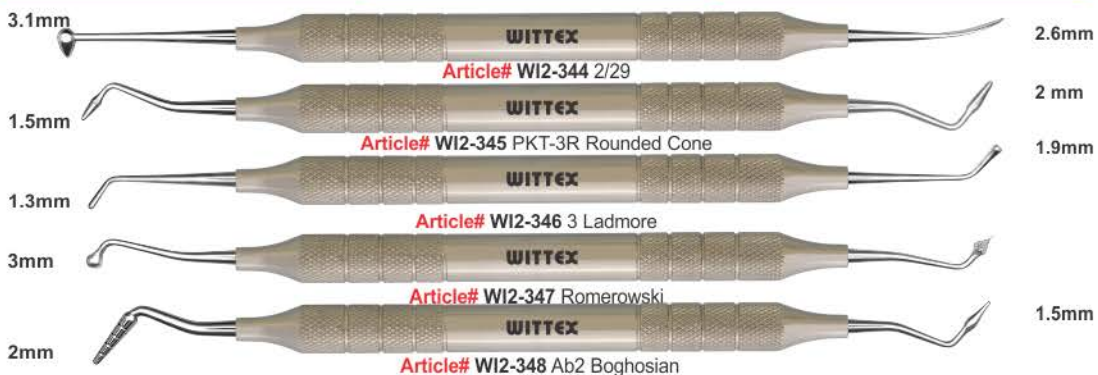

🇷🇺 Инструменты для реставрации  
🇮🇹 Instruments pour plombage  
🇩🇪 Füllungsinstrumente (mit Kontrawinkel)
 🇺🇦 Інструменти для реставрації  
🇪🇸 Instrumentos para obturaciones  
🇸🇦 ملء الصكوك

**AMALGAM CARVERS**



**PLASTIC-FILLING INSTRUMENTS, EXAXIAL SET**



**SPATULA / PLUGGER BURNISHER**



- 
- 
- 
- 

**SPATULA/PLUGGER COMBINATIONS**



**Article# W12-376** Spatula / Ball Plugger, 2.0 / Ø 1.0mm

**Article# W12-377** Spatula / Ball Plugger, 2.5 / Ø 1.6mm

**Article# W12-378** Spatula / Pear Plugger, 2.0 / Ø 1.0mm



**Article# W12-379** Dycal, Ø 0.6 / 0.9mm

**Article# W12-380** Mini Spatula / Dycal, 1.6 / Ø 0.8mm

**Article# W12-381** Planator, Ø 2.3 / 1.9mm

**Article# W12-382** Spatula / Ball Plugger, 3.2 / Ø 2.5mm

**Article# W12-383** Spatula / Pear Plugger, 2.5 / Ø 1.6mm

**Article# W12-384** Dycal, Ø 0.6 / 0.9mm

**Article# W12-385** Planator, Ø 1.7 / 1.4mm

**Article# W12-386** Ball plugger, Ø 1.6 / 1.2mm



**BALL / PLUGGER**

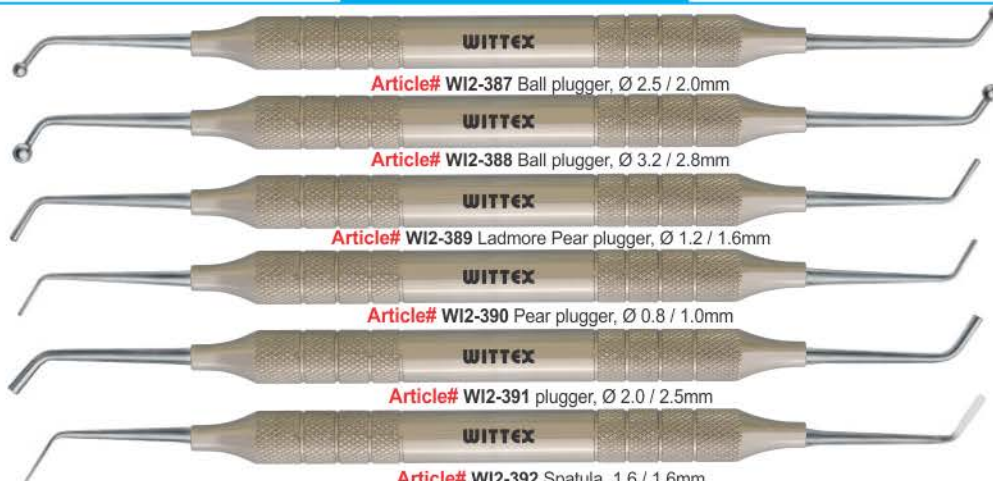

**Article# W12-387** Ball plugger, Ø 2.5 / 2.0mm

**Article# W12-388** Ball plugger, Ø 3.2 / 2.8mm

**Article# W12-389** Ladmore Pear plugger, Ø 1.2 / 1.6mm

**Article# W12-390** Pear plugger, Ø 0.8 / 1.0mm

**Article# W12-391** plugger, Ø 2.0 / 2.5mm

**Article# W12-392** Spatula, 1.6 / 1.6mm

- Инструменты для реставрации
- Instruments pour plombage
- Füllungsinstrumente (mit Kontrawinkel)
- Инструменти для реставрації
- Instrumentos para obturaciones
- ملء الصكوك

BURNISHERS CONSERVATIVE TREATMENT SET OF 6 PCS

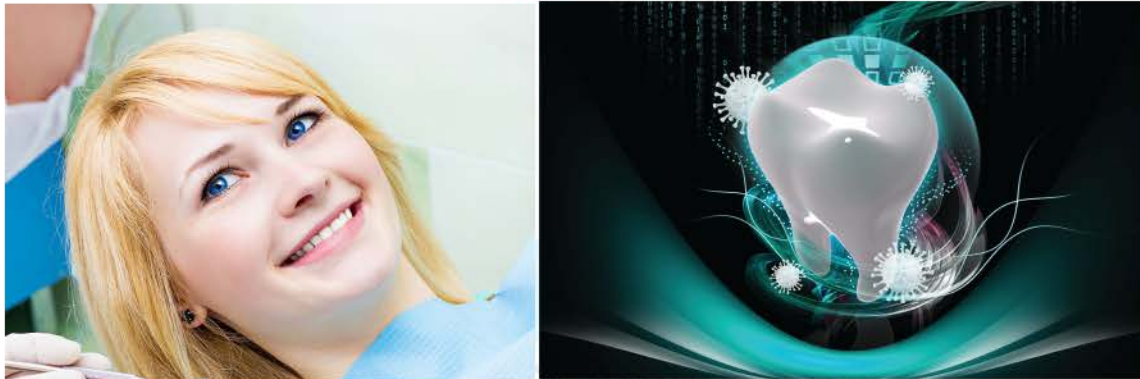

CARVER HOLLENBACK WAXING INSTRUMENTS



DISCOID-CLEOID INTERPROXIMAL CARVER Titanium Nitride (Tin) Carvers

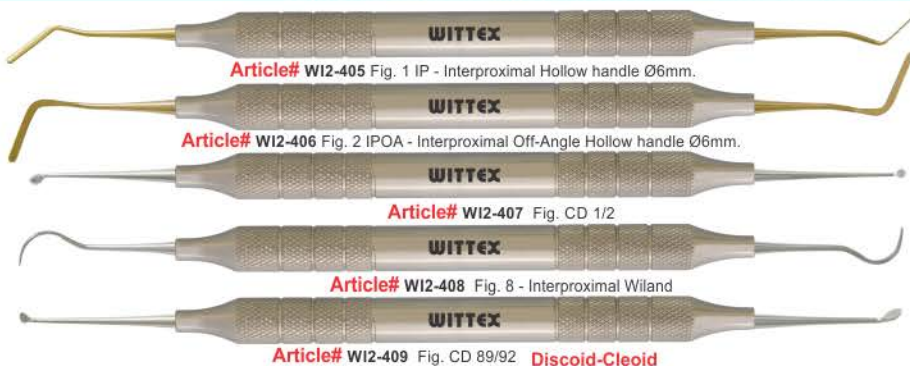

- |  |                                  |
|--|----------------------------------|
| ■ Инструменты для реставрации            | ■ Инструменти для реставрації    |
| ■ Instruments pour plombage              | ■ Instrumentos para obturaciones |
| ■ Füllungsinstrumente (mit Kontrawinkel) | ■ ملء الصكوك                     |

**DISCOID-CLEOID INTERPROXIMAL CARVER**



**TANNER FILLING INSTRUMENTS**



**BACK ACTION FILLING INSTRUMENTS**



**BALL BURNISHERS**



**RESTORATIVE  
SECTION 2**

■ Инструменты для реставрации  
■ Instruments pour plombage  
■ Füllungsinstrumente (mit Kontrawinkel)
 ■ Инструменти для реставрації  
■ Instrumentos para obturaciones  
■ ملء الصكوك

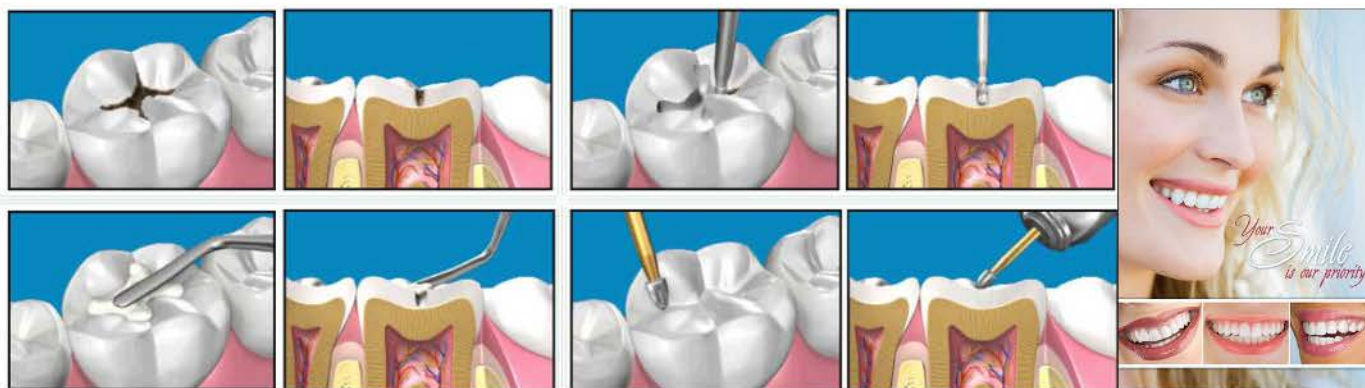
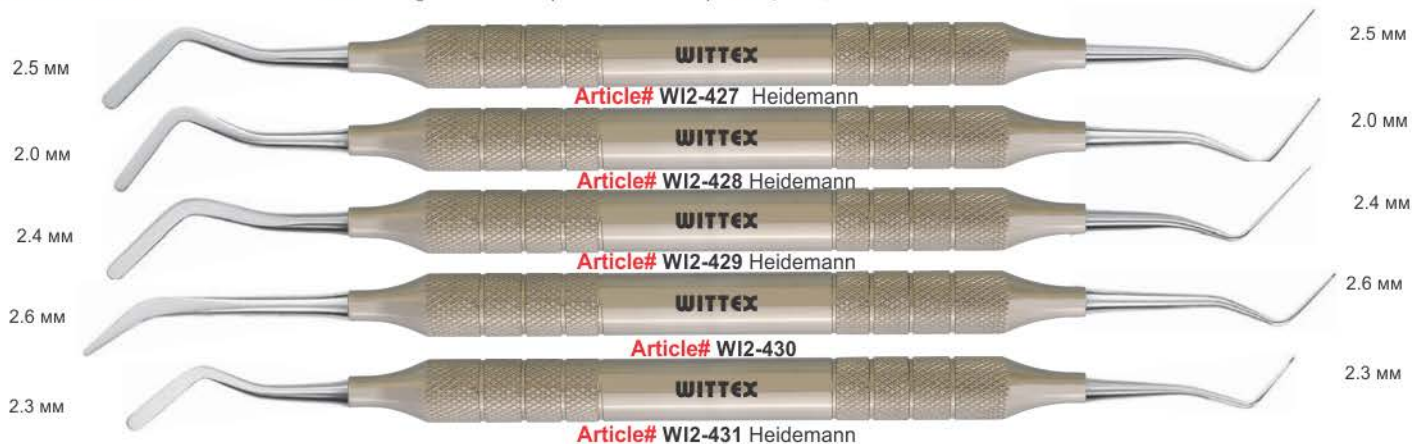

**SPATULAS-PLUGGERS**

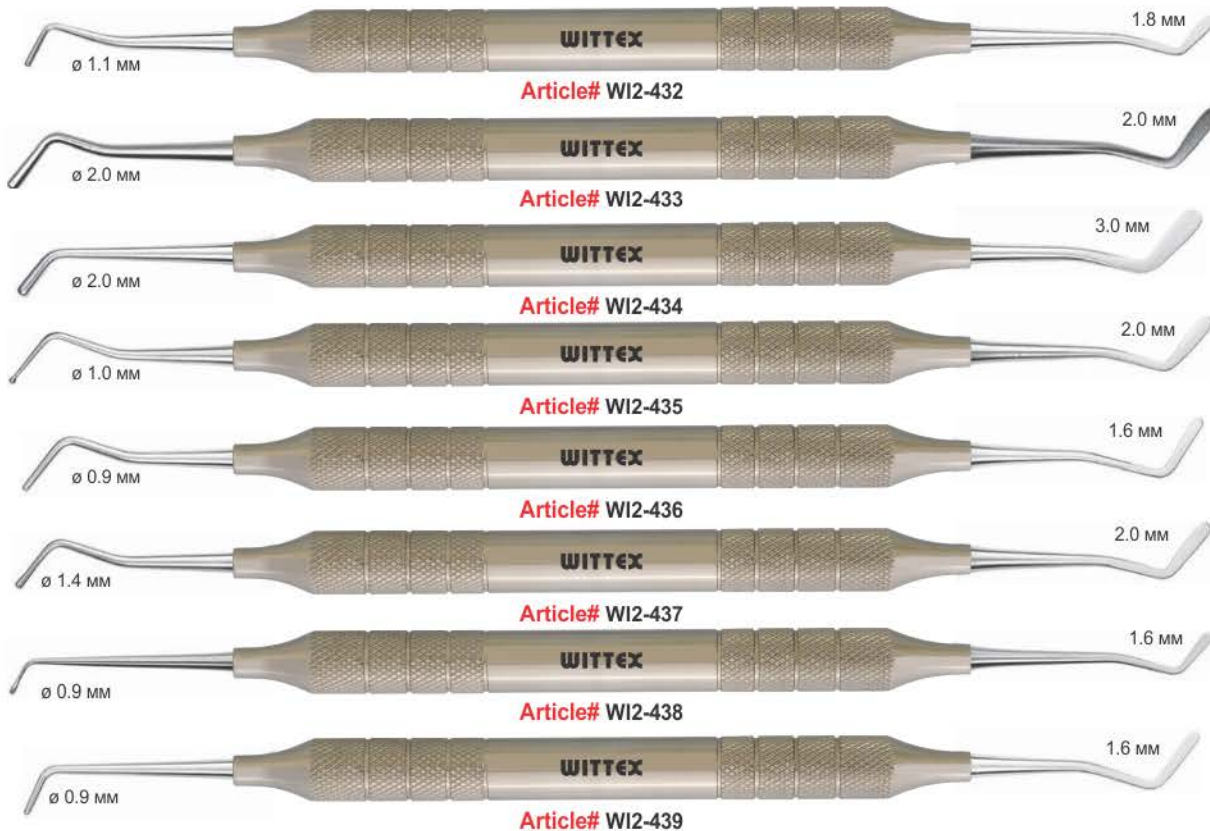

RESTORATIVE INSTRUMENTS

**BURNISHERS SET OF 5 PCS**

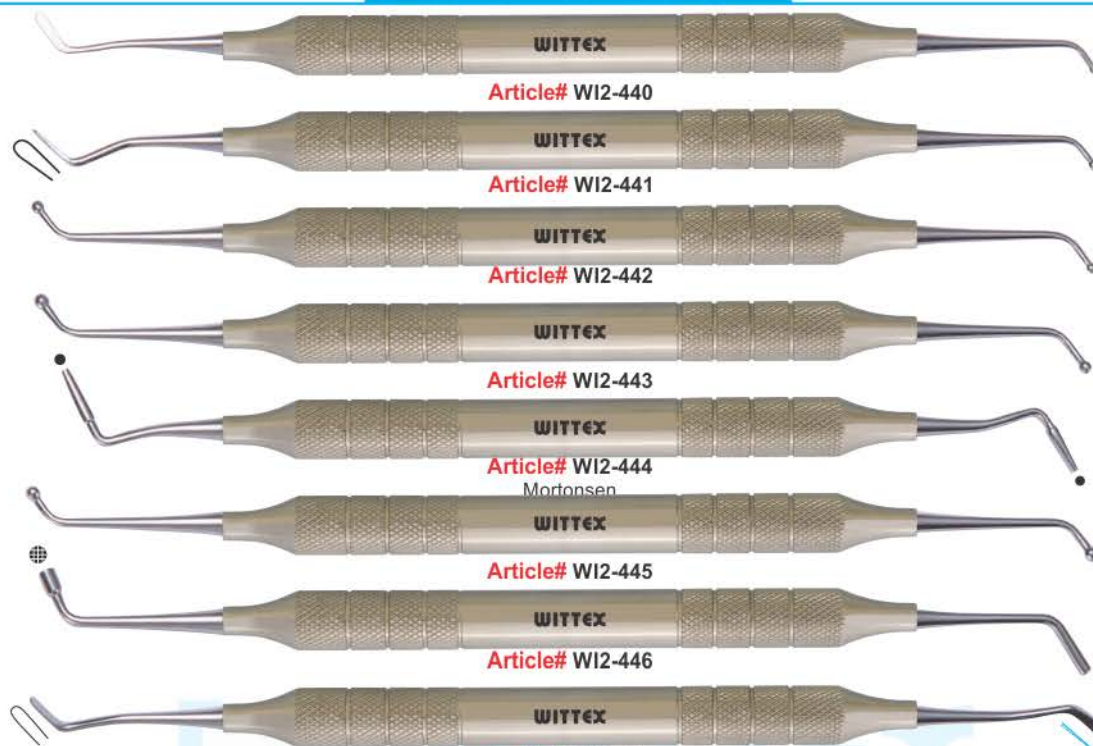

Article# W12-440

Article# W12-441

Article# W12-442

Article# W12-443

Article# W12-444

Mortensen

Article# W12-445

Article# W12-446

Article# W12-447



Article# W12-448 CPRO3C

Article# W12-449 Mo1 Monari

Article# W12-450 TH28C Hirt

Article# W12-451 HZ25C

Article# W12-452 Ck10

Article# W12-453 CK28BC

Article# W12-454 Op37 Carver

Article# W12-455 28BR29

- Инструменты для реставрации
- Instruments pour plombage
- Füllungsinstrumente (mit Kontrawinkel)
- Инструменти для реставрації
- Instrumentos para obturaciones
- ملء الصكوك

PLUGGER FILLING INSTRUMENTS



Here we have a cavity that has destroyed a part of the tooth.

The cavity is removed with a drill and the site is prepared. Note that this preparation is smaller than the other methods of tooth restoration.

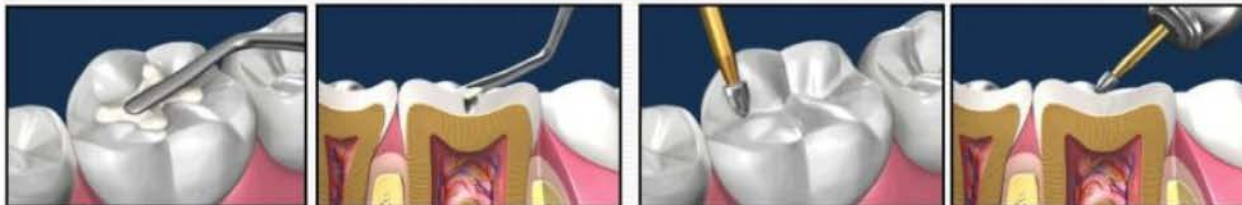

The preparation has a diverging shape towards the opening. A resin material is placed and packed in the prepared site.

The resin is then polished with polishing burs.

PLASTIC SPATULA FILLING INSTRUMENTS



- 
- 
- 
- 

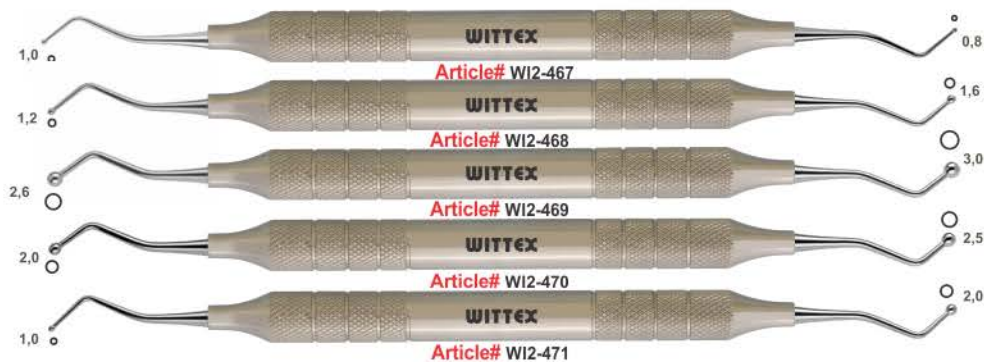

**FILLING INSTRUMENTS CONSERVATIVE TREATMENT**



Инструменты для реставрации

Instruments pour plombage

Füllungsinstrumente (mit Kontrawinkel) ملء الصكوك

Инструменти для реставрації

Instrumentos para obturaciones

**COMPOSITE PLUGGERS INSTRUMENTS**



**FILLING INSTRUMENTS CONSERVATIVE TREATMENT**

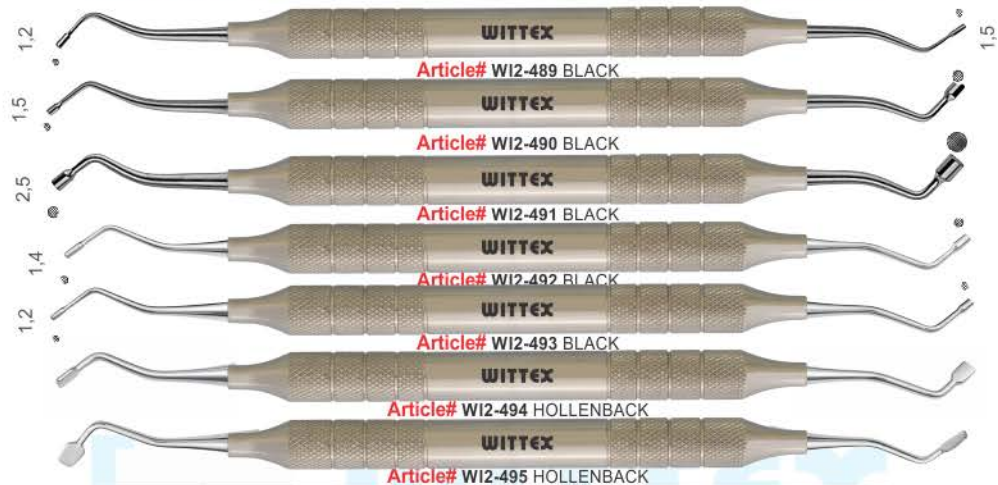

Here we have a cavity that has destroyed a part of the tooth.

The cavity is removed with a drill and the site is prepared. Note that this preparation is smaller than the other methods of tooth restoration.



🇷🇺 Инструменты для реставрации  
🇫🇷 Instruments pour plombage  
🇩🇪 Füllungsinstrumente (mit Kontrawinkel)  
🇮🇹 Инструменти для реставрації  
🇪🇸 Instrumentos para obturaciones  
🇸🇦 ملء الصكوك

RESTORATIVE INSTRUMENTS

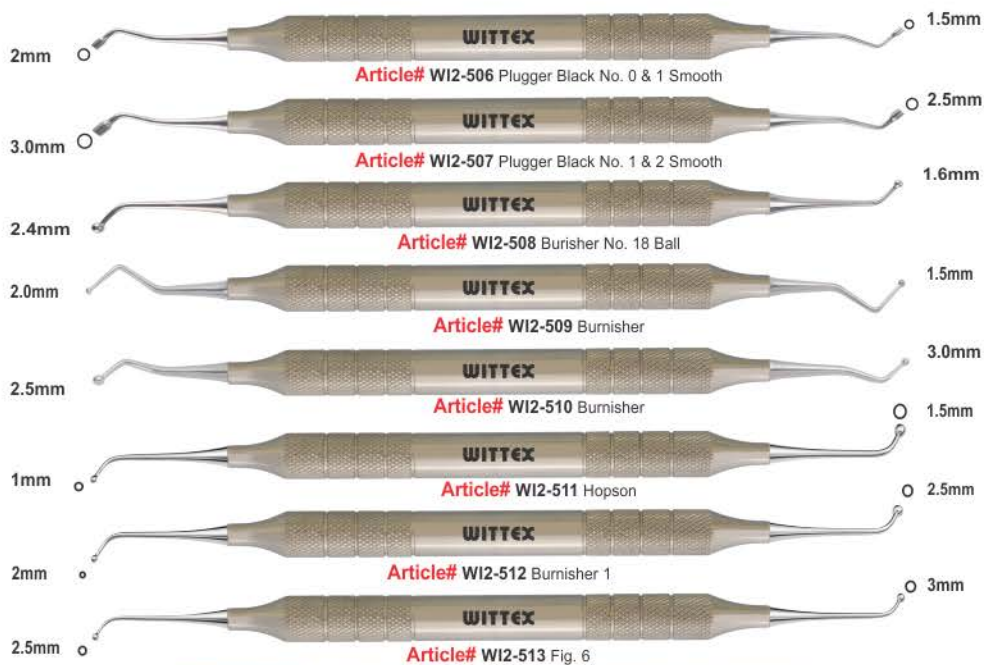

■ Инструменты для реставрации    ■ Инструменти для реставрації  
■ Instruments pour plombage    ■ Instrumentos para obturaciones  
■ Füllungsinstrumente (mit Kontrawinkel)    ■ ملء الصكوك



**COMPOSITE PLUGGERS INSTRUMENTS**

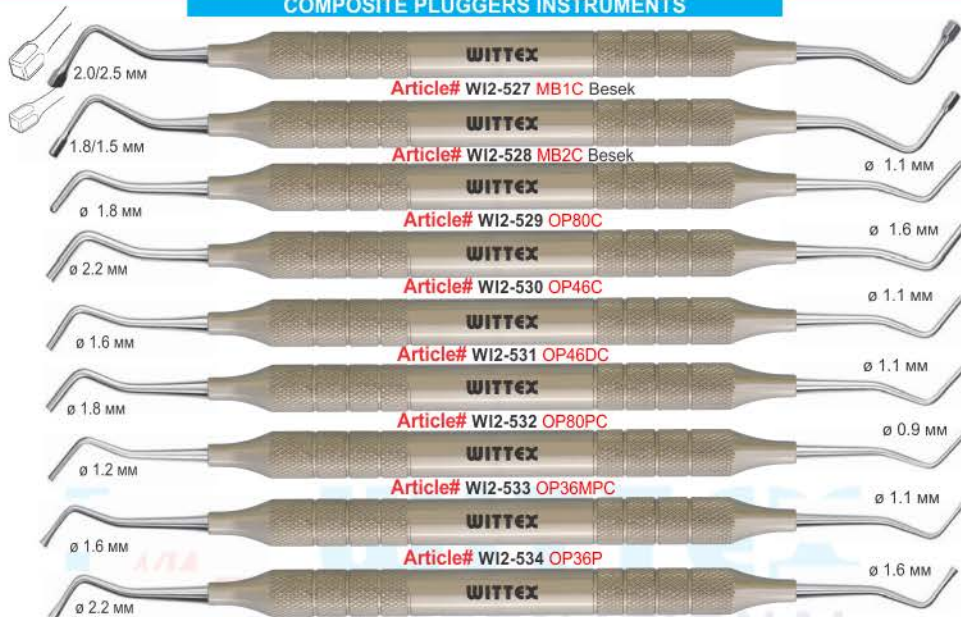

**White Dental Filling**



RESTORATIVE INSTRUMENTS

■ Инструменты для реставрации    ■ Инструменти для реставрації  
■ Instruments pour plombage    ■ Instrumentos para obturaciones  
■ Füllungsinstrumente (mit Kontrawinkel)    ■ ملء الصكوك

**EXCAVATORS SPOONS**



**OVAL SPOONS/DARBY-PERRY**



**EXCAVATORS**

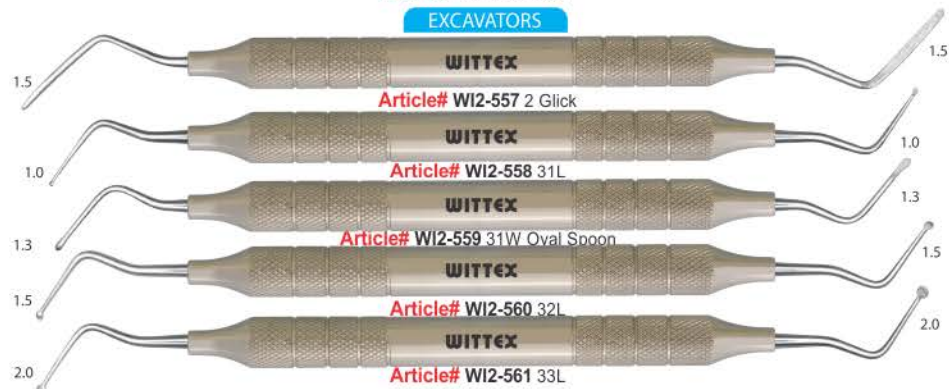

- 
- 
- 
- 

**EXCAVATORS INSTRUMENTS**



- 
- Инструменты для реставрации  
 Инструменти для реставрації  
 Instruments pour plombage  
 Instrumentos para obturaciones  
 Füllungsinstrumente (mit Kontrawinkel)  
 ملء الصكوك

**APPLICATIONS FOR EXCAVATORS**



A filling is a way to restore a tooth damaged by decay back to its normal function and shape

**HATCHETS RESTORATIVE INSTRUMENTS**



🇷🇺 Инструменты для реставрации     🇺🇦 Інструменти для реставрації  
🇫🇷 Instruments pour plombage     🇪🇸 Instrumentos para obturaciones  
🇩🇪 Füllungsinstrumente (mit Kontrawinkel)     🇸🇦 ملء الصكوك

**EXCAVATORS INSTRUMENTS**

1.2mm		1.5mm
	<b>Article# W12-592</b> Excavator D/E No. 17	
1.5mm		1.8mm
	<b>Article# W12-593</b> Excavator D/E No. 18	
2mm		2.2mm
	<b>Article# W12-594</b> Excavator D/E No. 19	
2.2mm		2.5mm
	<b>Article# W12-595</b> Excavator D/E No. 20	
2mm		1.5mm
	<b>Article# W12-596</b> Plugger Black No. 0 & 1 Serrated	
2.5mm		2mm
	<b>Article# W12-597</b> Plugger Black No. 1 & 2 Serrated	
2mm		1.5mm
	<b>Article# W12-598</b> Plugger Black No. 0 & 1 Smooth	
2.5mm		2mm
	<b>Article# W12-599</b> Plugger Black No. 1 & 2 Smooth	
	<b>Article# W12-600</b> Burisher No. 18 Ball	
1.2mm		1.5mm
	<b>Article# W12-601</b> Burnisher Michigan No. 1	
2mm		2.5mm
	<b>Article# W12-602</b> Burnisher Michigan No. 2	



**PLUGGER INSTRUMENTS**

1.2mm		1.5mm
	<b>Article# W12-603</b> Excavator D/E No. 17	
1.5mm		1.8mm
	<b>Article# W12-604</b> Excavator D/E No. 18	
2mm		2.2mm
	<b>Article# W12-605</b> Excavator D/E No. 19	
		1.4mm
	<b>Article# W12-606</b> Excavator 14	
2mm		1.5mm
	<b>Article# W12-607</b> Plugger Black No. 0 & 1 Serrated	
3.0mm		2.5mm
	<b>Article# W12-608</b> Plugger Black No. 1 & 2 Serrated	

EXCAVATORS SET OF 7 PCS

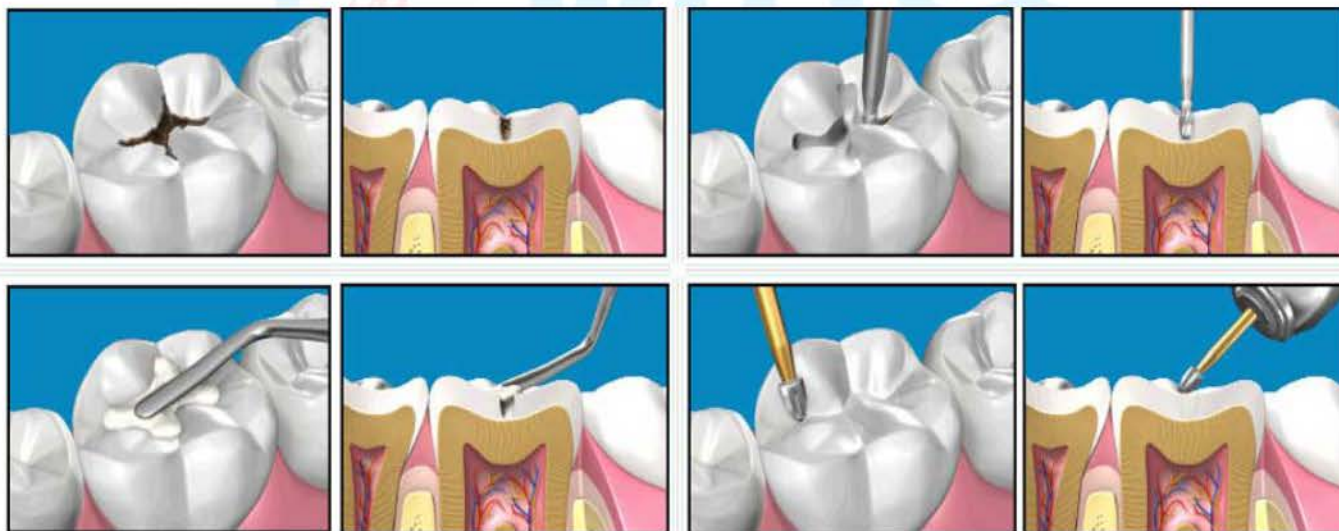
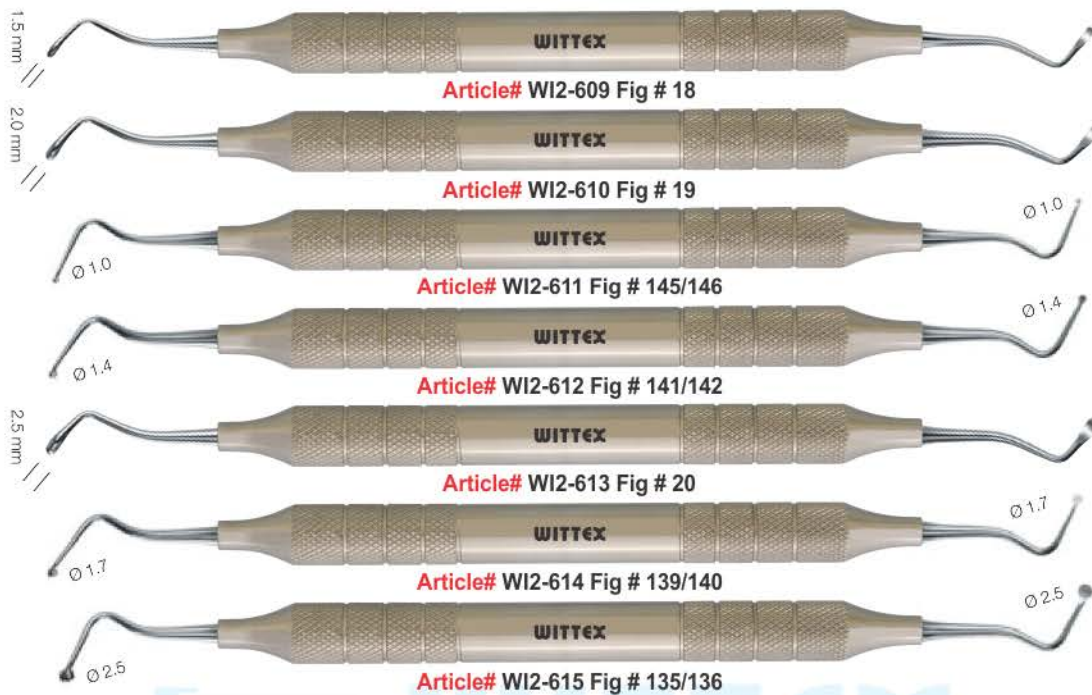

HOES



■ Инструменты для реставрации      ■ Инструменти для реставрації  
■ Instruments pour plombage      ■ Instrumentos para obturaciones  
■ Füllungsinstrumente (mit Kontrawinkel)      ■ ملء الصكوك

**ANTERIOR RESTORATIVE INSTRUMENTS**



**CARVERS INSTRUMENTS**



**TANNER**



🇷🇺 Инструменты для реставрации     🇮🇹 Инструменти для реставрації  
🇫🇷 Instruments pour plombage     🇪🇸 Instrumentos para obturaciones  
🇩🇪 Füllungsinstrumente (mit Kontrawinkel)     🇸🇦 ملء الصكوك

**WALL**



**WARD**



**ANDREW**



**CLAPPISON/FRAHAM**



**HOLLENBACK**



- |  |   |
|--|---|
| <ul style="list-style-type: none"> <li>■ Инструменты для реставрации</li> <li>■ Instruments pour plombage</li> <li>■ Füllungsinstrumente (mit Kontrawinkel)</li> </ul> | <ul style="list-style-type: none"> <li>■ Инструменти для реставрації</li> <li>■ Instrumentos para obturaciones</li> <li>■ ملء الصكوك</li> </ul> |
|--|---|

**CARVERS INSTRUMENTS**



**THARP**



**CARVERS**



Our goal is provide you with a comfortable experience and a beautiful smile that you desire



**AMALGAM FILES**



**HOES**

Forming Line Angles on Anterior Preparations.



- 
- 
- 
- 

**DISCOID-CLEOIDS**

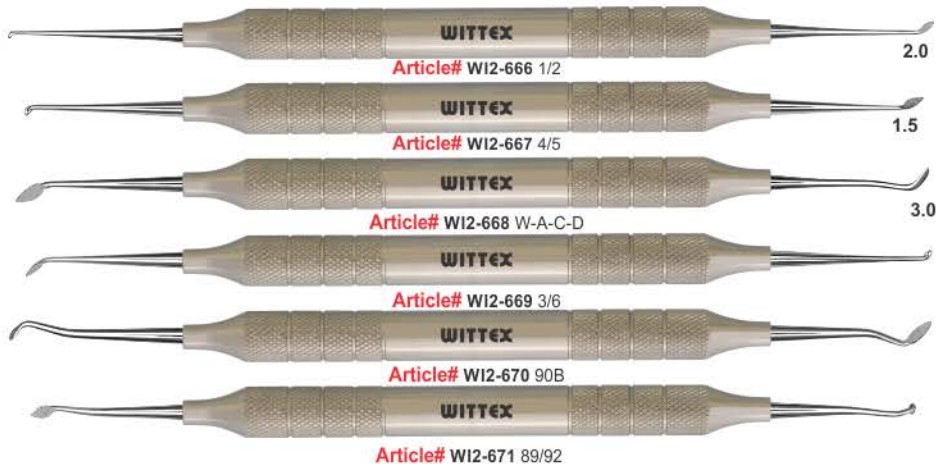

*Smile*



**MARGIN TRIMMERS**



**ANGLE FORMERS**



**PLUGGER**



■ Инструменты для реставрации    ■ Инструменти для реставрації  
■ Instruments pour plombage    ■ Instrumentos para obturaciones  
■ Füllungsinstrumente (mit Kontrawinkel)    ■ ملء الصكوك

**BEAVERTAIL**



**ACORN**



**HATCHETS**



**ANTERIOR**



**WALL**



- |  |                                  |
|--|----------------------------------|
| ■ Инструменты для реставрации            | ■ Инструменти для реставрації    |
| ■ Instruments pour plombage              | ■ Instrumentos para obturaciones |
| ■ Füllungsinstrumente (mit Kontrawinkel) | ■ ملء الصكوك                     |

**CARVERS**



Article# W12-704 Inter-proximal

Article# W12-705 Inter-proximal Off-Angle

Article# W12-706 3S Hollenback

Article# W12-707 1/2-3 Hollenback

Article# W12-708 3 Hollenback

Article# W12-709 8 Wiland Minn.IPC1



**TANNER**

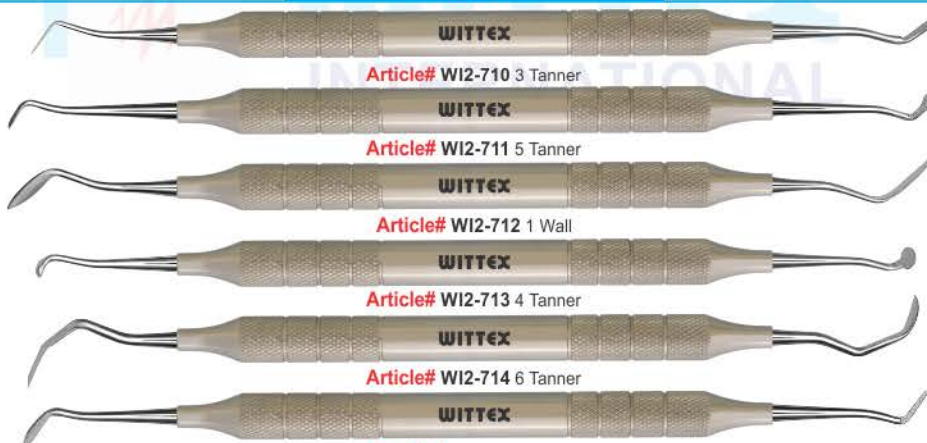

Article# W12-710 3 Tanner

Article# W12-711 5 Tanner

Article# W12-712 1 Wall

Article# W12-713 4 Tanner

Article# W12-714 6 Tanner

Article# W12-715 3 Wall

**ANDREW**



Article# W12-716 1 Andrew

Article# W12-717 2 Andrew

Article# W12-718 3 Andrew

**CLAPPISON/FRAHAM**



Article# W12-719 4 Clappison

Article# W12-720 2/3 Frahm

Article# W12-721 104

- 
- Инструменты для реставрации  
 Instruments pour plombage  
 Füllungsinstrumente (mit Kontrawinkel)  
 Инструменти для реставрації  
 Instrumentos para obturaciones  
 ملء الصكوك

**HOLLENBACK**



**THARP**



**CARVERS**



**DISCOID-CLEOIDS**

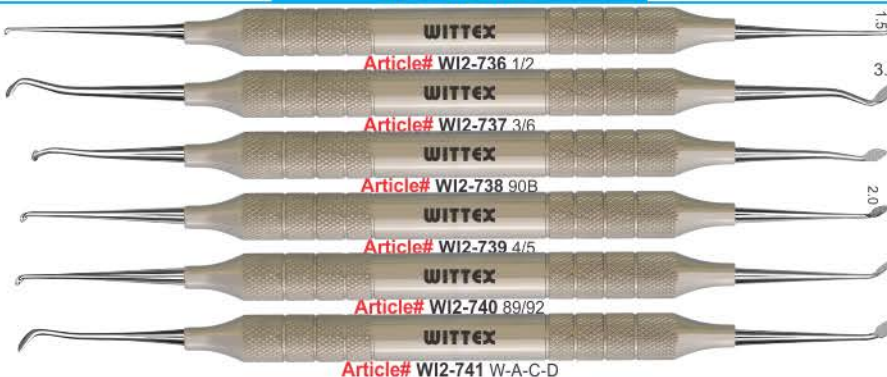

Инструменты пародонтологические  
Instruments pour la parodontologie  
Instrumente für die Parodontologie

Инструменти пародонтологічні  
instrumentos para periodoncia  
الصكوك اللثة

Periodontal Instruments Set



Article# WI2-750  
Set of 10 Pieces.



Cotton Meriam Tweezer



Dental Mirror Magnify No.5 with Handle



Article# WI2-742 Probe Fig. 9



Article# WI2-743 Excavator Tip Size Ø2mm-1,5mm



Article# WI2-744 Excavator Tip Size Ø1,2mm-1,5mm

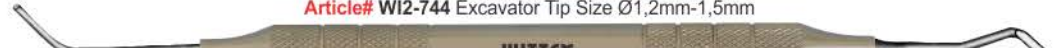

Article# WI2-745 Plugger Tip Size Ø1,5mm-2mm

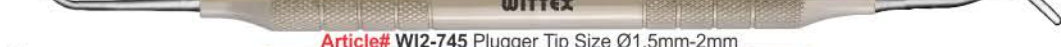

Article# WI2-746 Plugger Tip Size Ø2mm-2,5mm

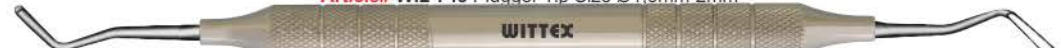

Article# WI2-747 Ironing Crescent Tip Size Ø3mm-3,2mm

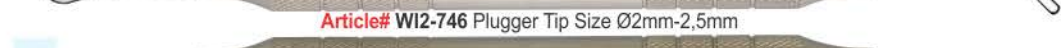

Article# WI2-748 Ironing Crescent Tip Size Ø2,5mm-2,5mm



Article# WI2-749 Cement Spatula Tip Size 6mm

RESTORATIVE INSTRUMENTS

	No intervention		Atypical restoration		Sealant
Healthy tooth surface					
Hypomineralisation					
Enamel breakdown					

- Инструменты для реставрации
- Instruments pour plombage
- Füllungsinstrumente (mit Kontrawinkel)
- Инструменти для реставрації
- Instrumentos para obturaciones
- ملء الصكوك

**COMPOSITE INSTRUMENTS**

Available in Hollow Handle Ø9.5mm

**Article# WI2-751 INSTRUMENTS FOR AESTHETIC RESTORATIONS SET OF 5 PCS**



Article# WI2-752



Article# WI2-753



Article# WI2-754



Article# WI2-755



Article# WI2-756



Article# WI2-757

Available in Hollow Handle Ø10mm

**Article# WI2-758 INSTRUMENTS FOR AESTHETIC RESTORATIONS SET OF 5 PCS**



Article# WI2-759



Article# WI2-760

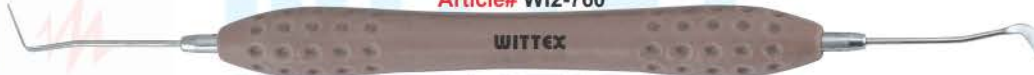

Article# WI2-761



Article# WI2-762



Article# WI2-763



Article# WI2-764

Available in Hollow Handle Ø9.5mm

**Article# WI2-765 INSTRUMENTS FOR AESTHETIC RESTORATIONS SET OF 5 PCS**



Article# WI2-766

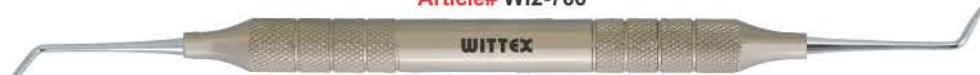

Article# WI2-767



Article# WI2-768



Article# WI2-769



Article# WI2-770



Article# WI2-771

- |  |   |
|--|---|
|  Кюрети   |  Кюрети  |
|  Curetas  |  Curette |
|  Küretten |  کورتس   |
|  水果       |   |

**INSTRUMENTS FOR AESTHETIC RESTORATIONS SET OF 5 PCS**

Article# W12-772



Article# W12-773 Applicata



Article# W12-774 Applicata Twist



Article# W12-775 Modella



Article# W12-776 Condensa



Article# W12-777 Fissura

**RESTORATION INSTRUMENTS FOR AESTHETIC RESTORATIONS SET 8 PCS**

Silicon Handle



Article# W12-778 Misura



Article# W12-779 Posterior Misura



Article# W12-780 Cusp Misura



Article# W12-781 Eccesso



Article# W12-782 Replica Posterior



Article# W12-783 Fissura



WITTEX



Condensa



Article# W12-784  
Set of 8 Pcs

Инструменты для реставрации

Instruments pour plombage

Füllungsinstrumente (mit Kontrawinkel)

Инструменти для реставрації

Instrumentos para obturaciones

ملء الصكوك

**Article# WI2-785 Dental Composite Resin Filling Spatula Aesthetic Restoration Set with Silicon Handle**

**Article# WI2-786**



**Article# WI2-787 Ct1**



**Article# WI2-788 Ct2**



**Article# WI2-789 Ct3**



**Article# WI2-790 Ct4**



**Article# WI2-791 Ct5**



**Article# WI2-792 Ct6**



**CT7**

**Article# WI2-793 LM SET OF 5 PCS**

**Article# WI2-794**



**Article# WI2-795**



**Article# WI2-796**



**Article# WI2-797**



**Article# WI2-798**



**Article# WI2-799**

**LM SET OF 7 PCS**

**Article# WI2-800**



■ Инструменты для реставрации    ■ Инструменти для реставрації  
■ Instruments pour plombage    ■ Instrumentos para obturaciones  
■ Füllungsinstrumente (mit Kontrawinkel)    ■ ملء الصكوك

**Article# WI2-801 RESTORATION INSTRUMENTS FOR AESTHETIC RESTORATIONS SET 7 PCS**

Article# WI2-802

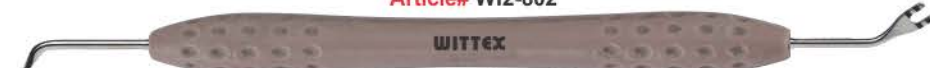

Article# WI2-803 Cusp Misura



Article# WI2-804 Solo Posterior



Article# WI2-805 Solo Anterior



Article# WI2-806 Posterior Misura



Article# WI2-807 Fissura



Article# WI2-808 Applica Twist



Article# WI2-809 Applica

**Article# WI2-810 Composite Set Of 10 Pices**



Article# WI2-811



Article# WI2-812



Article# WI2-813



Article# WI2-814



Article# WI2-815



Article# WI2-816



Article# WI2-817



Article# WI2-818



Article# WI2-819



Article# WI2-820

Available in Hollow Handle Ø9.5mm  
**Article# W12-821 COMPOSITE SET OF 10 PCS**



**Article# W12-822** Implant Misura MR 3.0-5.0



**Article# W12-823** Implant Misura MR 3.1-5.3



**Article# W12-824** Implant Misura MR 3.3-5.6



**Article# W12-825** Implant Misura MR 3.4-5.8



**Article# W12-826** Implant Misura MR 3.7-6.3

RESTORATIVE INSTRUMENTS

**Article# W12-827 P.K. THOMAS WAX CARVER SET OF 5 PCS**

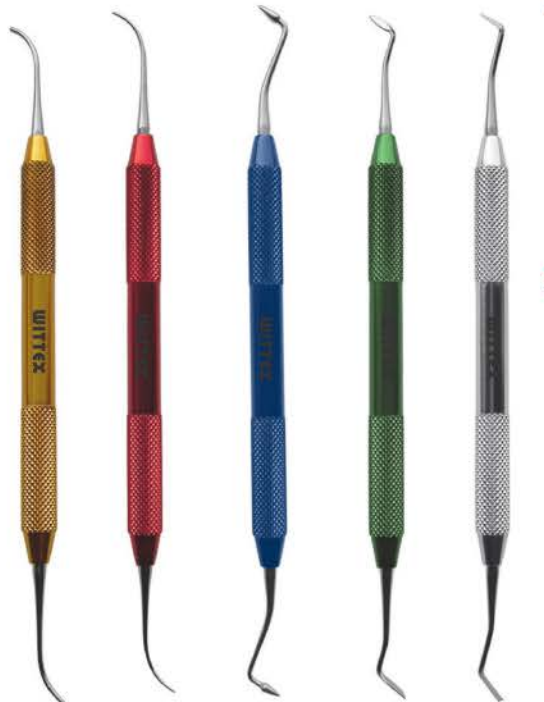

**Article# W12-828** PKT-1  
**Article# W12-829** PKT-2  
**Article# W12-830** PKT-3  
**Article# W12-831** PKT-4  
**Article# W12-832** PKT-5



**Article# W12-833**  
 Composite Instruments  
 Set of 6 Pcs  
 Blue Titanium  
 with Cassettes

Available in Hollow Handle Ø9.5mm  
**COMPOSITE INSTRUMENTS TITANIUM BLUE ENDODONTIC**

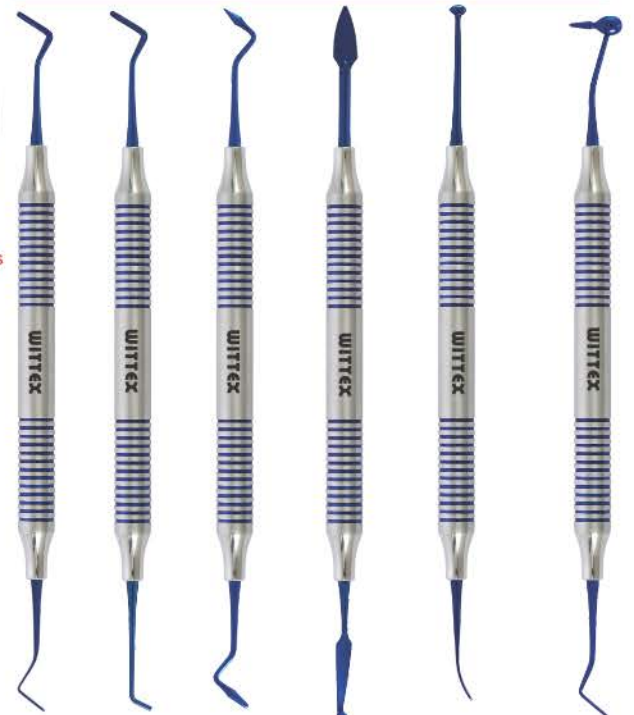

**Article# W12-834**  
**Article# W12-835**  
**Article# W12-836**  
**Article# W12-837**  
**Article# W12-838**  
**Article# W12-839**

# COMPOSITE SET AND LABORATORY INSTRUMENT



COMPOSITE SET AND LABORATORY

Шпатели для цемента  
Spatules à ciment  
Zementspatel

Шпатели для цементу  
Espátulas para cemento  
ملاعق الأسمنت

**DENTAL SPATULAS SET**

COMPOSITE SET AND LABORATORY



**Article#**  
WI3-840  
No.1



**Article#**  
WI3-841



**Article#**  
WI3-842



**Article#**  
WI3-843  
#1



**Article#**  
WI3-844  
#7



**Article#**  
WI3-845  
#31



**Article#**  
WI3-846



**Article#**  
WI3-847  
Fig. 1



**Article#**  
WI3-848  
Fig. 2



**Article#**  
WI3-849  
Fig. 3

Available in Hollow Handle Ø 8 mm, Ø 10 mm Solid Handle Ø 6 mm



**Article#**  
WI3-850  
Fig. 00



**Article#**  
WI3-851  
Fig. 0



**Article#**  
WI3-852  
Fig. 1



**Article#**  
WI3-853  
Fig. 2



**Article#**  
WI3-854  
Fig. 3



**Article#**  
WI3-855  
Fig. 4



**Article#**  
WI3-856  
Weston



**Article#**  
WI3-857



**Article#**  
WI3-857



**Article#**  
WI3-858

Шпатели для цемента  
Spatules à ciment  
Zementspatel

Шпателі для цементу  
Espátulas para cemento  
ملاعق الأسمنت

**WAX AND MODELLING CARVERS**



**Article#**  
WI3-859  
Le Cron

**Article#**  
WI3-860  
Le Cron  
160 mm



**Article#**  
WI3-861  
Zahle  
120 mm



**Article#**  
WI3-862  
Zahle



**Article#**  
WI3-863  
Zahle



**Article#**  
WI3-864  
Zahle



**Article#**  
WI3-865  
Gritman



**Article#**  
WI3-866  
Beale



**Article#**  
WI3-867  
Roach



**Article#**  
WI3-868  
Vehe

**CARVERS INSTRUMENTS**



**Article#** WI3-869  
Carvers Set of 10 Pcs  
01 Wax Knife  
02 Cement Spatulas  
03 Cement Spatulas  
04 Cement Spatulas  
05 Cement Spatulas  
06 Cement Spatulas  
07 Cement Spatulas  
08 Cement Spatulas  
09 Cement Spatulas  
10 Cement Spatulas



**Article#**  
WI3-870  
Graded Handle  
Hylin Carver



**Article#**  
WI3-871  
Hylin



**Article#**  
WI3-872  
Hylin-Le Cron



**Article#**  
WI3-873  
Hylin-Ceramica



**Article#**  
WI3-874  
Hylin



**Article#**  
WI3-875  
Le Cron



**Article#**  
WI3-876  
Le Cron



**Article#**  
WI3-877  
Le Cron



**Article#**  
WI3-878  
Le Cron

Шпатели для цемента  
Spatules à ciment  
Zementspatel

Шпатели для цементу  
Espátulas para cemento  
ملاعق الأسمنت

**ZIRCONIA DENTAL LABORATORY SET 3 PCS**



**ZIRCONIA DENTAL LABORATORY SET 8 PCS**



**COMPOSITE INSTRUMENTS SET**

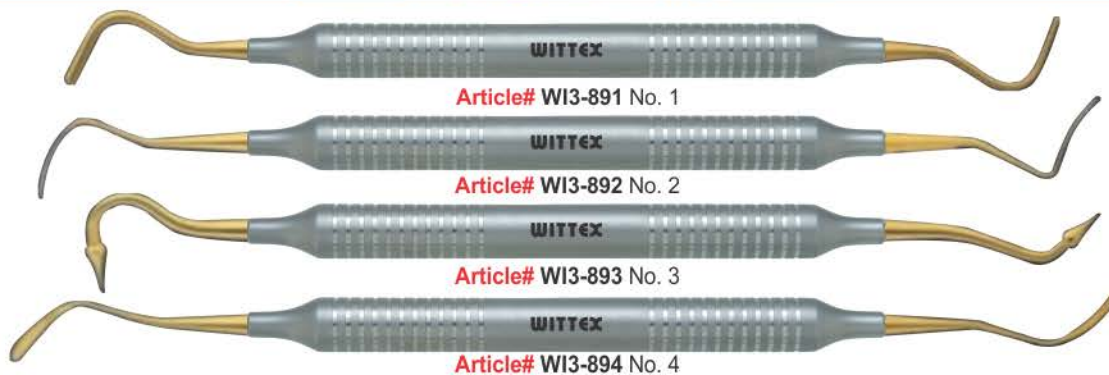

**WAX KNIVES**



**Article# WI3-895**  
Fig. 1  
Fahnenstock  
125mm



**Article# WI3-896**  
Fig. 2  
Fahnenstock  
170mm



**Article# WI3-897**  
Fig. 1  
Lessmann  
125mm



**Article# WI3-898**  
Fig. 2  
Lessmann  
170mm



**Article# WI3-899**  
Fig. 1  
with small spoon  
125mm



**Article# WI3-900**  
Fig. 2  
with large spoon  
170mm

**PLASTER KNIVES**



**Article# WI3-901**  
160mm



**Article# WI3-902**  
160mm



**Article# WI3-903**  
Buffalo



**Article# WI3-904**  
Buffalo



**Article# WI3-905**  
Plaster Knife



**Article# WI3-906**  
170mm

Ножи для воска  
Couteaux a cire  
Wachsmesser

Ножи для воску  
Cuchillos para cera  
السكاكين الشمع

**WAX KNIVES**



**Article#**  
WI3-907  
Sachs



**Article#**  
WI3-908  
130mm  
Ermert



**Article#**  
WI3-909  
Hook Knives



**Article#**  
WI3-910  
125mm Antkoviak



**Article#**  
WI3-911



**Article#**  
WI3-912 17cm  
WI3-913 20cm  
Special Inox



**Article#**  
WI3-914  
Fig. 1  
18.5 cm



**Article#**  
WI3-915  
Fig. 2  
18 cm

**WAX SPATULAS**



**Article#** WI3-916  
Wooden Handle  
19.5cm curved



**Article#** WI3-917  
Wooden Handle  
20cm curved



**Article#** WI3-918  
Wooden Handle  
22.5cm curved



**Article#** WI3-919  
Wooden Handle  
19.5cm



**Article#** WI3-920  
Wooden Handle  
21.5cm



**Article#** WI3-921  
Wooden Handle  
20.5cm



**Article#** WI3-922  
Plastic Handle  
20.5cm



Open View



Denture Flask Lower, Brass  
Article# W13-923  
Close View



Open View



Denture Flask Upper, Brass  
Article# W13-924  
Close View



Open View



Round Dental Flask, Brass  
Article# W13-925  
Close View



Open View



Small Flask with Compressor, Brass  
Article# W13-926



Compressor Single Flask  
Article# W13-927



Compressor Double Flask  
Article# W13-928



Compressor Double Flask  
Article# W13-929



Dental Flask  
4 Parts, Brass  
Article# W13-930  
Close View



Dental Single  
Flask, Brass  
Article# W13-931  
Close View



Dental Flask,  
4 Parts Silver  
Article# W13-932  
Close View



Dyerline Flask,  
Silver  
Article# W13-933  
Close View



Round Dental  
Flask, Silver  
Article# W13-934  
Close View



- Артикуляторы
- Artocilar
- Artikulations
- Артикулятори
- Articuler
- آرتیکولاتورس



Article# WI3-935  
Articulator



Article# WI3-936  
Articulator



Article# WI3-937  
Articulator  
S



Article# WI3-938  
Articulator  
M



Article# WI3-939  
Articulator



Article# WI3-940  
Articulator  
L

Артикуляторы  
Artocilar  
Artikulations

Артикулятори  
Articuler  
آرتیکولاتورس



Article# WI3-941  
Articulator



Article# WI3-942  
Articulator



Article# WI3-943  
Articulator



Article# WI3-944  
Articulator



Article# WI3-945  
Articulator



Article# WI3-946  
Articulator



**Article# WI3-947**

**Technical Datas:**

Intercondylar distance	120 mm.
condylar inclination	fixed at 30°
Bennet angle	fixed at 7°
Incisal table inclination	10°
Distance between mounting plates	110 mm.
Weight	700 gr.
Opening	180°

**features:**

Lightweight anathomic articulator made of aluminum die-casting. it can be used following the geometrical laws of medium values (Bonwill triangle). Fixing according to centric. Automatic return to the hinge axis with springs. Perfect stability also in recversed position. Easy access and visibility to the lingual surfaces. interchangeable self centring aluminum mounting plates.



**Article# WI3-948**

**Technical Datas:**

Intercondylar distance	120 mm.
condylar inclination	fixed at 30°
Bennet angle	fixed at 7°
Incisal table inclination	flat
Distance between mounting plates	110 mm.
Weight	700 gr.
Opening	180°

**Special Features:**

Adjustable back by registration screw to work without incisal rod by keeping constant trajectories and inclinations during side and back/forward movements. Pure translation movement (kay and instructions included). Anti-shock hinge rod in case articulator falls down. Bigger size lock screws for mounting plates.



**Increased height and width**

- (1) More space when using removable stumps systems.
- (2) More space for installation of mobile prosthesis with high chewing or big base.
- (3) More space when using magnetic plates



**Article# WI3-949**

**Technical Datas:**

Intercondylar distance	120 mm.
condylar inclination	fixed at 30°
Bennet angle	fixed at 7°
Incisal table inclination	10°
Distance between mounting plates	85 mm.
Weight	400 gr.
Opening (item 5000)	125°
Opening (item 5010)	180°



**Article# WI3-950**

**Technical Datas:**

Intercondylar distance	110 mm.
condylar inclination	fixed at 30°
Bennet angle	fixed at 7°
Incisal table inclination	flat
Distance between mounting plates	85 mm.
Weight	450 gr.
Opening	180°



**Article# WI3-951**

**Anvil**  
Dental Laboratory  
Instrument

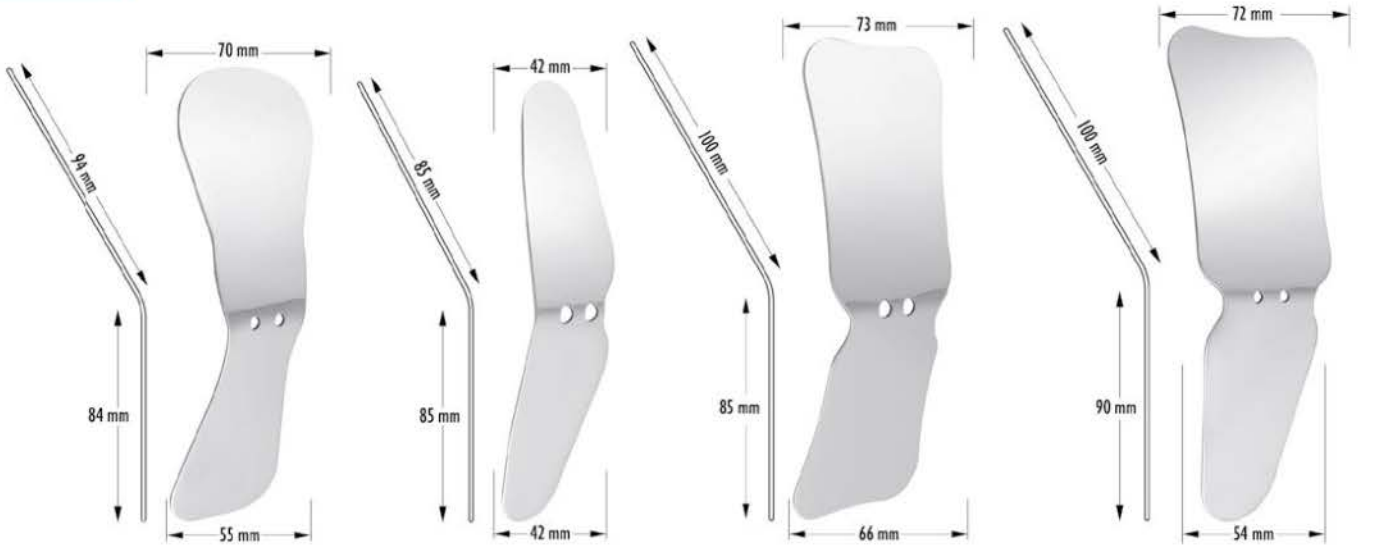

**Article#**  
**W13-952** Adult Palatal /  
**W13-953** Child Palatal

**Article#** **W13-954**  
Buccal

**Article#**  
**W13-955** Adult Palatal /  
**W13-956** Child Palatal

**Article#**  
**W13-957** Adult Palatal /  
**W13-958** Adult Buccal

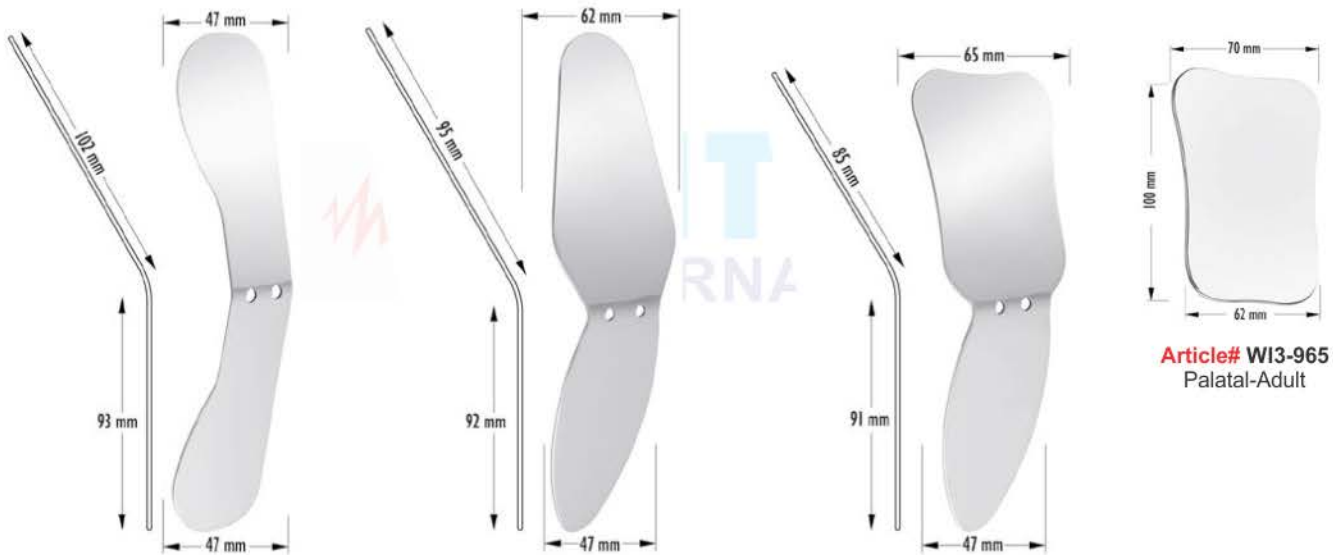

**Article#**  
**W13-959** Lingual upper /  
**W13-960** Lingual Lower

**Article#**  
**W13-961** Adult Buccal /  
**W13-962** Child Buccal

**Article#**  
**W13-963** Child Palatal /  
**W13-964** Child Buccal

**Article#** **W13-965**  
Palatal-Adult

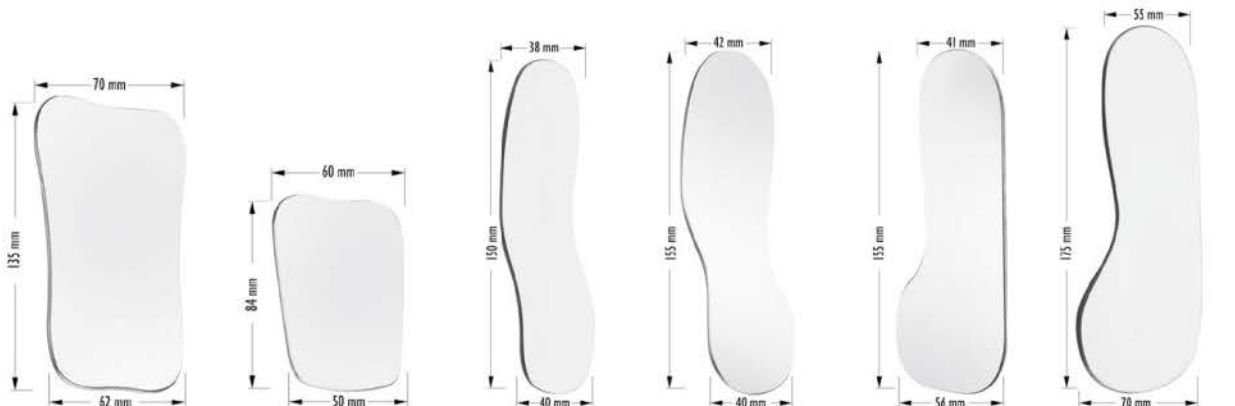

**Article#** **W13-966**  
Palatal-Adult Large



**Article#** **W13-967**  
Palatal-Child

**Article#** **W13-968**  
Buccal-Small

**Article#** **W13-969**  
Buccal

**Article#** **W13-970**  
Lingual

**Article#** **W13-971**  
Lingual-Large

 Прочие товары  
 Divers produits et services  
 Sonstige Produkte

 Інші товари  
 Varios Productos  
 المنتجات المتنوعة



**Article# WI3-972**  
X Ray Film Hanger



**Article# WI3-973**  
X Ray Film Hanger



**Article# WI3-974**  
X Ray Film Hanger



**Article# WI3-975**  
X Ray Film Hanger



**Article# WI3-976**  
Napkin Holder with  
Plastic Chain



**Article# WI3-977**  
Napkin holder with metal chain



**Article# WI3-978**  
Mouth Props  
Small

**Article# WI3-978**  
Mouth Props  
Medium

**Article# WI3-979**  
Mouth Props  
Large

**Key Rings**



**Article# WI3-980**



**Article# WI3-981**



**Article# WI3-982**



**Article# WI3-983**



**Article# WI3-984**



**Article# WI3-985**

COMPOSITE SET AND LABORATORY



**Article#**  
**WI3-986**  
Metal tip  
22cm  
Hammer With Wooden Handle



**Article#**  
**WI3-987**  
Metal tip  
22cm

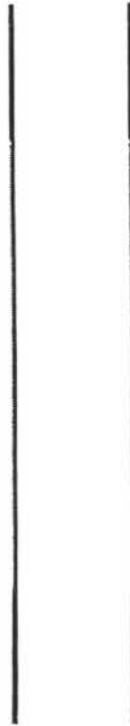

**Article#**  
**WI3-988**  
1  
For plaster

**Article#**  
**WI3-989**  
2  
For metal



**Article#**  
**WI3-990**  
Fret saw  
25cm



**Article#**  
**WI3-991**  
Small  
Saw Blades



**Article#**  
**WI3-992**  
Large  
Saw Blades



**Article#**  
**WI3-993**  
Ceri Saw



**Article#** **WI3-994**  
Plaster Shears  
20cm



Crucible Tongs  
**Article#**  
**WI3-995** 25cm  
**WI3-996** 32cm



**Article#** **WI3-997**  
Ceri Saw  
18cm



**Article#** **WI3-998**  
Blade  
0,12x5 mm  
Conf. 12 pcs



**Article#** **WI3-999**  
Blade  
0,25x5 mm  
Conf. 12 pcs



**Article#** **WI3-1000**  
Blade  
0,25x3 mm  
Conf. 12 pcs

Dental Instruments With Rainbow Plasma Coating.

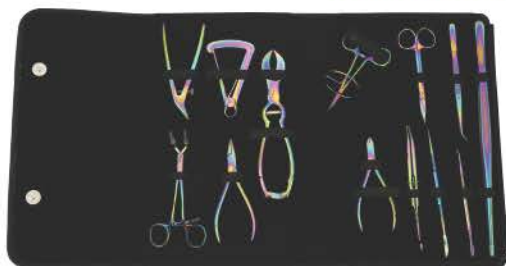

**Article# W13-1001**  
Dental Instruments Set  
Set of 13

**Article# W13-1002**  
Bending Plier  
11.5cm, Box Joint.



**Article# W13-1014**  
Goldman Fox Scissor  
13cm Cvd.



**Article# W13-1013**  
H/Mosquito Forceps 13cm  
with Ring Support



**Article# W13-1003**  
Pointed Plier  
12.5cm, Box Joint.



**Article# W13-1004**  
Bohm Dental Pliers  
13cm Diamond Coated.



**Article# W13-1012**  
Keramo Grip Plier  
12.7cm Cvd.



**Article# W13-1011**  
Jacket Grip Crown Plier  
13cm D/Curved.



**Article# W13-1005**  
Iwanson Metal  
Caliper 11cm

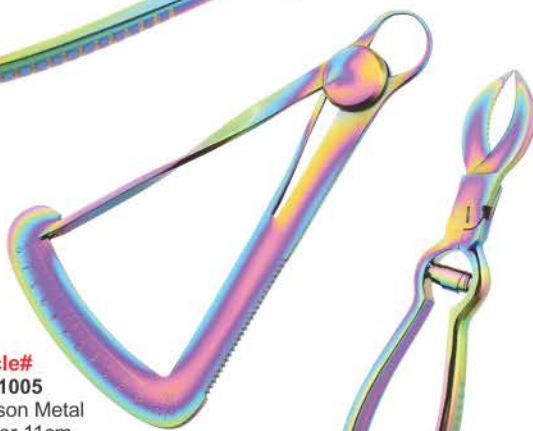

**Article# W13-1010**  
Thumb Dressing  
Forceps, 30cm.



**Article# W13-1006**  
Plaster Shear  
With Spring.



**Article# W13-1007**  
Zahle Iecron  
13cm D/E.



**Article# W13-1008**  
Iecron +Carvers,  
16cm D/E.



**Article# W13-1009**  
Dental Tweezer  
15cm.



COMPOSITE SET AND LABORATORY

# ENDO AND ENDO MICRO SURGERY KITS

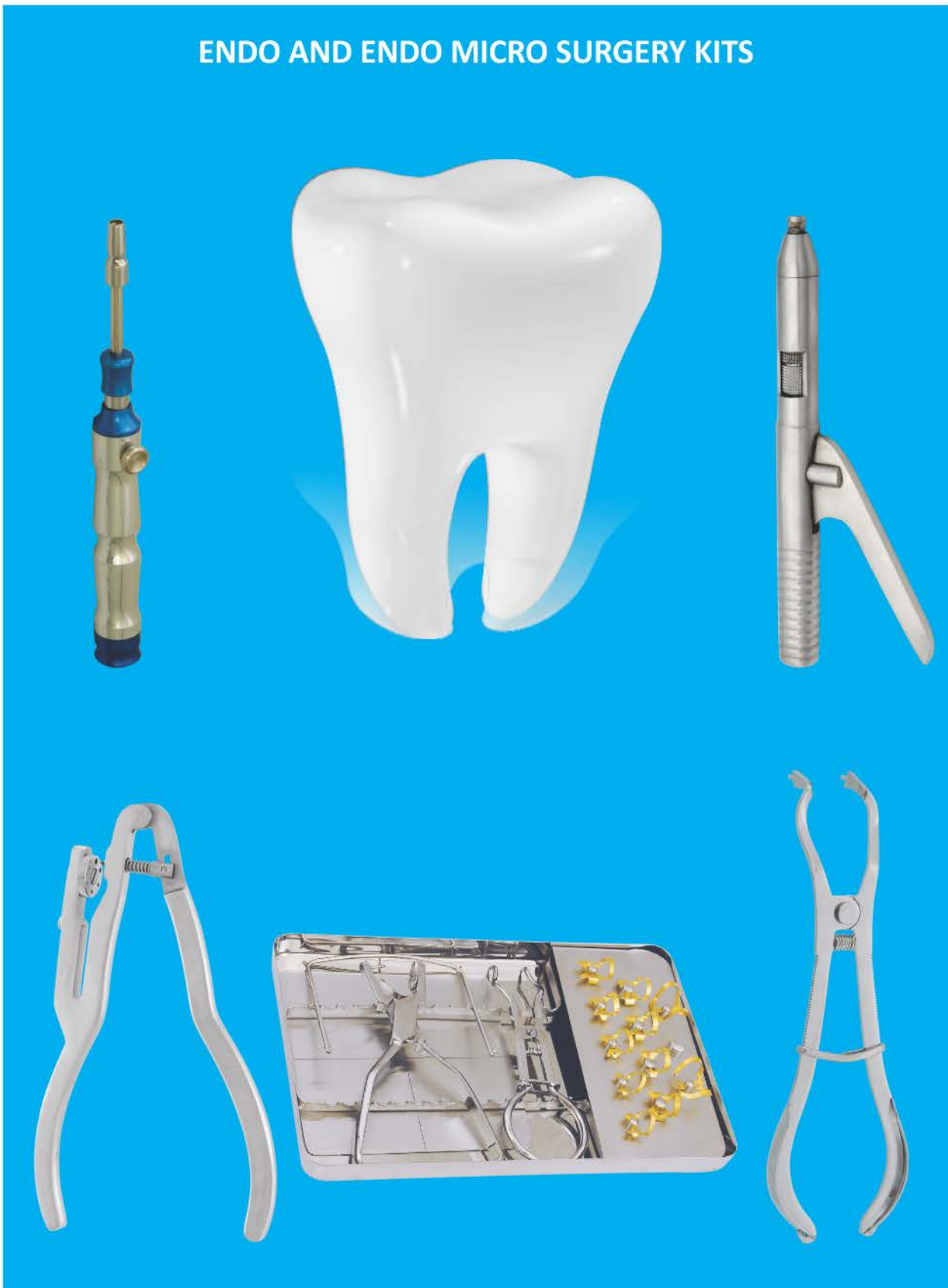

Инструменты для системы коффердам  
 Pincès porte-crampons à dique  
 Kofferdam Klammerzangen

Инструменти для системи коффердам  
 Pinzas de engrapar para dique de caucho  
 السد المطاط الملقط المشابك



Article# WI4-001  
Anisworth



Article# WI4-002  
Ivory



Article# WI4-003  
Elastic  
Separating & Ligature  
Plier



Article# WI4-004  
Elastic  
Separating & Ligature  
Plier



Article# WI4-005  
Brewer



Article# WI4-006  
Stockes



Article# WI4-007  
Palmer



Article# WI4-008  
Ivory  
light weight

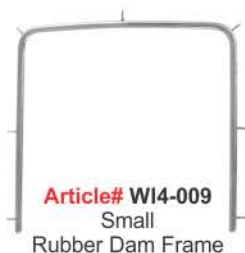

Article# WI4-009  
Small  
Rubber Dam Frame



Article# WI4-010  
Medium  
Rubber Dam Frame



Article# WI4-011  
Large  
Rubber Dam Frame

Инструменты для системы коффердам  
Pinces porte-crampons a dique  
Kofferdam Klammerzangen

Инструменти для системи коффердам  
Pinzas de engrapar para dique de caucho  
السد المطاط الملقط المشابك



**Article# WI4-012**

On request the Content of the rubber dam kit can be changed with other instruments.

**Content:**

- 01 Anisworth
- 02 Brewer
- 03 Clamps Stand
- 04 Rubber Dam Frame L
- 05 Rubber Dam Frame M
- 06 Rubber Dam Box Lower Case
- 07 Rubber Dam Box Upper Case

- 08 Rubber Dam Clamp Fig. 212
- 09 Rubber Dam Clamp Fig. 211
- 10 Rubber Dam Clamp Fig. 8
- 11 Rubber Dam Clamp Fig. 8A
- 12 Rubber Dam Clamp Fig. 14
- 13 Rubber Dam Clamp Fig. 14A
- 14 Rubber Dam Clamp Fig. 0
- 15 Rubber Dam Clamp Fig. 00
- 16 Rubber Dam Clamp Fig. 2
- 17 Rubber Dam Clamp Fig. 2A
- 18 Rubber Dam Clamp Fig. 7



**Article# WI4-013**

On request the Content of the rubber dam kit can be changed with other instruments.

**Content:**

- 01 Ivory
- 02 Ivory light weight
- 03 Clamps Stand
- 04 Rubber Dam Frame M
- 05 Rubber Dam Frame L
- 06 Rubber Dam Box Lower Case
- 07 Rubber Dam Box Upper Case

- 08 Rubber Dam Clamp Fig. 209
- 09 Rubber Dam Clamp Fig. 212
- 10 Rubber Dam Clamp Fig. 211
- 11 Rubber Dam Clamp Fig. 8
- 12 Rubber Dam Clamp Fig. 8A
- 13 Rubber Dam Clamp Fig. 14
- 14 Rubber Dam Clamp Fig. 14A
- 15 Rubber Dam Clamp Fig. 0
- 16 Rubber Dam Clamp Fig. 00
- 17 Rubber Dam Clamp Fig. 2
- 18 Rubber Dam Clamp Fig. 2A
- 19 Rubber Dam Clamp Fig. 7

ENDO AND ENDO MICRO SURGERY KITS



**Article# WI4-014**  
Rubber Dam Set of 12 Pcs

- 01 Anisworth
- 02 Rubber Dam Frame
- 03 Ivory
- 04 Clamp
- 05 Clamp
- 06 Clamp
- 07 Clamp
- 08 Clamp
- 09 Clamp
- 10 Clamp
- 11 Clamp
- 12 Clamp

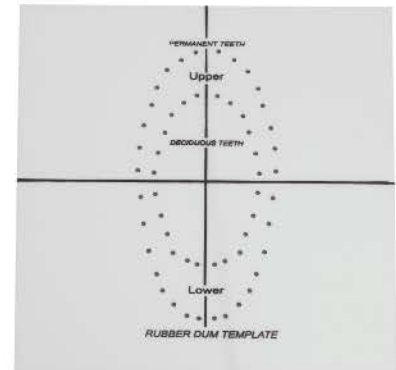

**Article# WI4-015**  
Rubber Dum Template

Кламмера для коффердама  
 Srampons pour dique  
 Kofferdam Klammern

Кламмера для коффердама  
 Grapas para dique de caucho  
 المشابك السد المطاط



Article# WI4-016

Stainless Steel Gold Plated Rubber Dam Clamp Tray with 11 Different Clamps  
 Fig. 212, 211, 8, 8A, 14, 14A, 0, 00, 2, 2A, 7



Article# WI4-017

Stainless Steel Rubber Dam Clamp Tray with 12 Different Clamps  
 Fig. 209, 212, 211, 8, 8A, 14, 14A, 0, 00, 2, 2A, 7



Article# WI4-018

Anisworth 17cm, Ivory 17cm  
 Brewer 17.5cm, Rubber Dam Frame (Children)  
 Ruber Dam Frame (Adult), Ruber Dam Clamps 11 Pcs  
 Fig. 00, Fig.0, Fig.1, Fig.2A, Fig.3, Fig.7,  
 Fig.8, Fig.8A, Fig.9, Fig.212, Fig.14



Article# WI4-019

Ruber Dam Clamps 13 Pcs Black Color Tray  
 B4, 212L, 212R, W00, W2, W3, W7, W8A,  
 W8AD, 12A, 13A, 26N, 27 Long Black



Article# WI4-020

Stainless Steel Rubber Dam Clamp Tray with 8 Different Clamps  
 Fig. 1, 26, 29, 51, 60, 202, 205, 210



Article# WI4-021

Stainless Steel Rubber Dam Clamp Tray  
 (without clamps)

Rubber Dam Clamps Organizing Board



Article# WI4-022

Rubber Dam Clamp Organizing Board,  
 For 8 Clamps



Article# WI4-023

Rubber Dam Clamp Organizing Board,  
 For 12Clamps

Кламмера для коффердама  
 Стамpons pour dique  
 Kofferdam Klammern

Кламмера для коффердама  
 Grapas para dique de caucho  
 المشابك السد المطاط

All rubber dam clamps are made from surgical stainless steel. Matt finish of these Satin Steel Rubber Dam Clamps offset bright clinical lighting. Hand-crafted to absorb and dissipate light instead of reflecting it back. This section includes the Anterior Rubber Clamps.

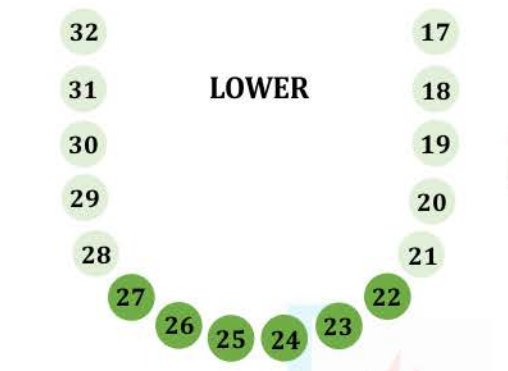
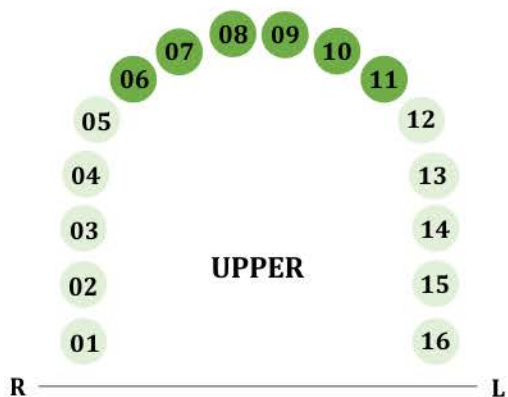

**Article# W14-024**  
**00**  
 Flat jaws and high bow for small lower canines and first premolars



**Article# W14-025**  
**6**  
 Slightly offset jaws for labial caries on anterior teeth



**Article# W14-026**  
**9**  
 Offset flat jaws and stiff bow for anterior teeth



**Article# W14-027**  
**9S**  
 Offset flat serrated jaws for anterior teeth.



**Article# W14-028**  
**212SA**  
 Slightly offset staggered jaws for odd shaped anterior.



**Article# W14-029**  
**212**  
 Flat jaws for labial caries on anterior teeth.

Rubber Dam Clamps -Molar (General)

All rubber dam clamps are made from surgical stainless steel. Matt finish of these Satin Steel Rubber Dam Clamps offset bright clinical lighting. Hand-crafted to absorb and dissipate light instead of reflecting it back. This section includes the Molar (General) Rubber Clamps.

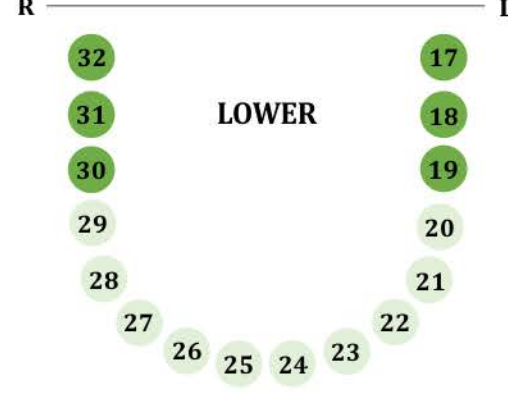
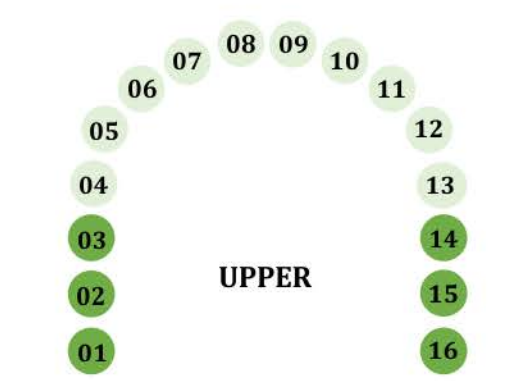

**Article# W14-030**  
**8A**  
 Deeply festooned four-point jaws for molars



**Article# W14-031**  
**W8A**  
 Slightly festooned jaws for molars.



**Article# W14-032**  
**10**  
 Flat jaws designed for small upper left and lower right molars.



**Article# W14-033**  
**11**  
 Flat jaws designed for small upper right & lower left molars



**Article# W14-034**  
**14**  
 Deeply festooned jaws for partially erupted molars



**Article# W14-035**  
**14A**  
 Deeply festooned jaws for partially erupted or irregularly shaped molars



**Article# W14-036**  
**W14A**  
 Deeply festooned jaws for partially erupted or irregularly shaped molars



**Article# W14-037**  
**18**  
 Flat jaws and stiff bow for molars



**Article# W14-038**  
**24**  
 Flat jaws for upper right and lower left molars



**Article# W14-039**  
**25**  
 Flat jaws for upper left and lower right molars



**Article# W14-040**  
**27**  
 Flat jaws for large molars



**Article# W14-041**  
**56**  
 Slightly festooned jaws for large molars



**Article# W14-042**  
**56S**  
 Slightly festooned serrated jaws for large partially erupted molars

Кламмера для коффердама  
 Grappons pour dique  
 Kofferdam Klammern

Кламмера для коффердама  
 Grapas para dique de caucho  
 المشابك السد المطاط

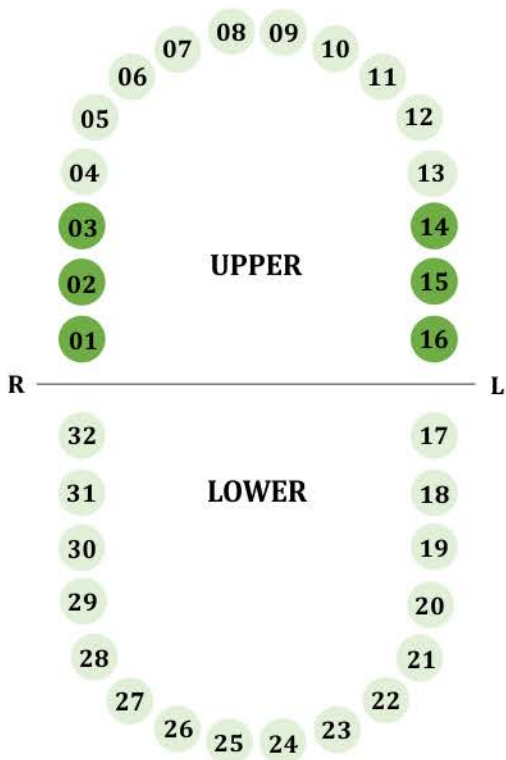
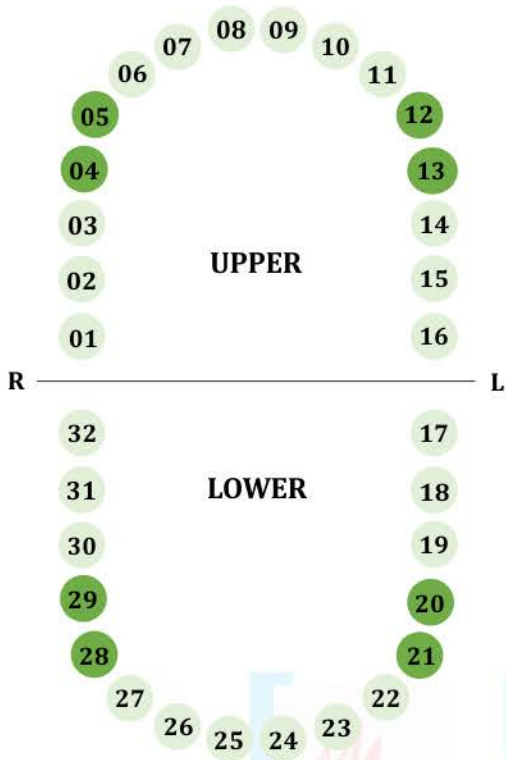

Rubber Dam Clamps -Premolar

All rubber dam clamps are made from surgical stainless steel. Matt finish of these Satin Steel Rubber Dam Clamps offset bright clinical lighting. Hand-crafted to absorb and dissipate light instead of reflecting it back. This section includes the Premolar Rubber Clamps.

 <b>Article#</b> W14-043 0 Flat jaws and high bow for longer premolars.	 <b>Article#</b> W14-044 1 Slightly festooned jaws for upper premolars.	 <b>Article#</b> W14-045 1A Deeply festooned jaws for canines and premolars.
 <b>Article#</b> W14-046 2 Flat jaws for premolars.	 <b>Article#</b> W14-047 2A Flat jaws for larger premolars.	 <b>Article#</b> W14-048 27N Slightly festooned jaws for premolars.
 <b>Article#</b> W14-049 29 Flat jaws for lower premolars.	 <b>Article#</b> W14-050 209 Small, flat jaws with stiff bow for lower premolars.	 <b>Article#</b> W14-051 W2 Flat jaws for premolars.

Rubber Dam Clamps -Upper Molar

All rubber dam clamps are made from surgical stainless steel. Matt finish of these Satin Steel Rubber Dam Clamps offset bright clinical lighting. Hand-crafted to absorb and dissipate light instead of reflecting it back. This section includes the Upper Molar Rubber Clamps.

 <b>Article#</b> W14-052 4 Flat narrow jaws for small upper molars.	 <b>Article#</b> W14-053 W4 Flat narrow jaws for small upper molars.	 <b>Article#</b> W14-054 5 Slightly festooned jaws for large upper molars.
 <b>Article#</b> W14-055 8 Deeply festooned jaws for upper molars.	 <b>Article#</b> W14-056 26N Flat jaws for upper molars.	 <b>Article#</b> W14-057 30 Offset jaws for upper right molars.
 <b>Article#</b> W14-058 31 Offset jaws for upper left molars.	 <b>Article#</b> W14-059 201 Slightly festooned jaws for upper molars.	 <b>Article#</b> W14-060 205 Slightly festooned jaws for large upper molars.

Кламмера для коффердама  
 Grappons pour dique  
 Kofferdam Klammern

Кламмера для коффердама  
 Grapas para dique de caucho  
 المشابك السد المطاط

Rubber Dam Clamps -Lower Molar

All rubber dam clamps are made from surgical stainless steel. Matt finish of these Satin Steel Rubber Dam Clamps offset bright clinical lighting. Hand-crafted to absorb and dissipate light instead of reflecting it back. This section includes the Lower Molar Rubber Clamps.

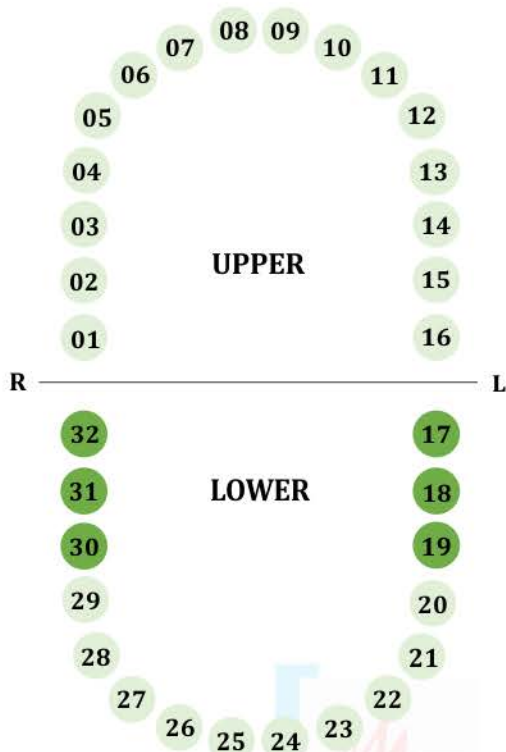

Article# WI4-061  
3

Flat narrow jaws for small lower molars.



Article# WI4-062  
7

Flat jaws for lower molars



Article# WI4-063  
7A

Slightly reversed festooned jaws for large lower molars



Article# WI4-064  
12A

Serrated offset jaws for lower right molars



Article# WI4-065  
13A

Serrated offset jaws for lower left molars



Article# WI4-066  
26

Slightly reversed festooned jaws for small lower molars



Article# WI4-067  
28

Flat jaws for lower molars



Article# WI4-068  
W3

Flat narrow jaws for small lower molars



Article# WI4-069  
W7

Flat jaws for lower molars.



Article# WI4-070  
Plier For Clamp

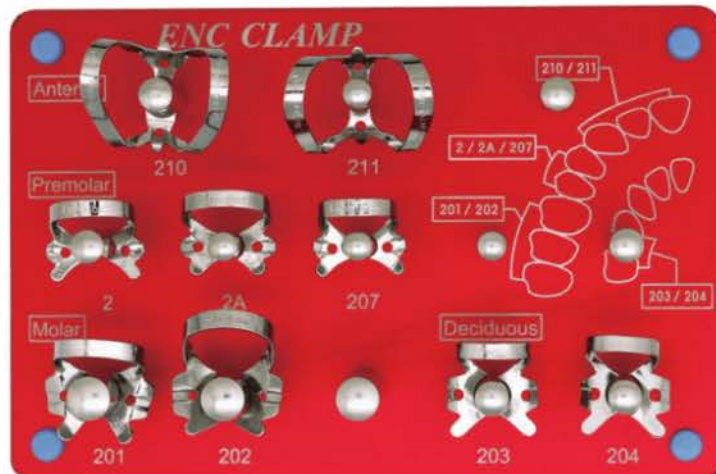

Article# WI4-071  
Enc Clamp Kit 11 Pcs

Кламмера для коффердама  
Crampons pour dique  
Kofferdam Klammern

Кламмера для коффердама  
Grapas para dique de caucho  
المشابك السد المطاط



Article# WI4-072 Fig. 15    Article# WI4-073 Fig. 18    Article# WI4-074 Fig. 24    Article# WI4-075 Fig. 25    Article# WI4-076 Fig. 26



Article# WI4-077 Fig. 28    Article# WI4-078 Fig. 30    Article# WI4-079 Fig. 31    Article# WI4-080 Fig. 51



Article# WI4-081 Fig. 138    Article# WI4-082 Fig. 139    Article# WI4-083 Fig. 200    Article# WI4-084 Fig. 201    Article# WI4-085 Fig. 202



Article# WI4-086 Fig. 203    Article# WI4-087 Fig. 204    Article# WI4-088 Fig. 205    Article# WI4-089 Fig. 3



Article# WI4-090 Fig. W3    Article# WI4-091 Fig. 4    Article# WI4-092 Fig. 56A    Article# WI4-093 Fig. 7    Article# WI4-094 Fig. 7A



Article# WI4-095 Fig. 8    Article# WI4-096 Fig. 8A    Article# WI4-097 Fig. W8A    Article# WI4-098 Fig. 10



Article# WI4-099 Fig. 11    Article# WI4-100 Fig. 12A    Article# WI4-101 Fig. 13A    Article# WI4-102 Fig. 14    Article# WI4-103 Fig. 14A



Article# WI4-104 Fig. 14AN    Article# WI4-105 Fig. 22    Article# WI4-106 Fig. 27    Article# WI4-107 Fig. 207



Article# WI4-108 Fig. 206    Article# WI4-109 Fig. 208    Article# WI4-110 Fig. 209    Article# WI4-111 Fig. 1    Article# WI4-112 Fig. 1



Article# WI4-113 Fig. 1A    Article# WI4-114 Fig. 2    Article# WI4-115 Fig. 2A    Article# WI4-116 Fig. W2A



Article# WI4-117 Fig. 0    Article# WI4-118 Fig. 00    Article# WI4-119 Fig. 210    Article# WI4-120 Fig. 211



Article# WI4-121 Fig. 212    Article# WI4-122 Fig. 6    Article# WI4-123 Fig. 9



Article# WI4-124 Fig. N06



Article# WI4-125 Fig. U67



Article# WI4-126 Fig. P1



Article# WI4-127 Fig. P2



Article# WI4-128 Fig. G-1



Article# WI4-129 Fig. G-2

Инструменты для удаления коронок  
 Arrache-couronnes  
 Teleskopkronenzangen

Инструменти для видалення коронок  
 Arranca-corona  
 مزيلات الناج

ENDO AND ENDO MICRO SURGERY KITS



Article# WI4-130  
Crown Spreaders



Article# WI4-131  
Crown Spreaders  
with Spring



Article# WI4-132  
Wynman Crown Gripper  
No Lock T.C 16 cm



Article# WI4-133  
Crown Spreader



Article# WI4-134  
Fig. 1



Article# WI4-135



Article# WI4-136  
Crown Spreaders  
Fig. 3



Article# WI4-137  
Offset Crown Splitter  
Remover Elevator



Article# WI4-138  
Christenson crown remover  
Straight, facial use anterior



Article# WI4-139  
Christenson crown remover  
Angled, for posterior use

Инструменты для удаления коронок  
Arrache-couronnes  
Teleskopkronenzangen

Инструменти для видалення коронок  
Arranca-corona  
مزيلات التاج



Article# WI4-140  
16cm

Crown Plier with plastic inserts Straight  
For ceramical and plastic crowns and bridges, with plastic inserts (sterilization up to 180° C).



Article# WI4-141  
14.5cm

Crown Plier with plastic inserts Angled



Article# WI4-142  
14cm

Universal plier for the removal of ceramic crowns and bridges



Article# WI4-143  
14cm

Universal plier for the removal of ceramic crowns and bridges



Article# WI4-144  
Furrer  
Copper Ring  
Removing Plier.  
15cm Curved



Article#  
WI4-145 12.5 cm  
WI4-146 15.0 cm  
Böhm Pliers for telescope crowns.  
Diamond points coated.



Article# WI4-147  
Nerve-Canal Pliers  
straight



Article# WI4-148  
Nerve-Canal Pliers  
Curved

Инструменты для удаления коронок  
 Arrache-couronnes  
 Teleskopkronenzangen

Инструменти для видалення коронок  
 Arranca-corona  
 مزيلات التاج

ENDO AND ENDO MICRO SURGERY KITS



Article# W14-149  
 Crown Remover  
 Set of 4 Pcs



Article# W14-150  
 Crown Remover  
 Set of 4 Pcs



Article# W14-151  
 Crown Remover  
 Set of 4 Pcs



Article# W14-152  
 Crown Remover  
 Set of 4 Pcs

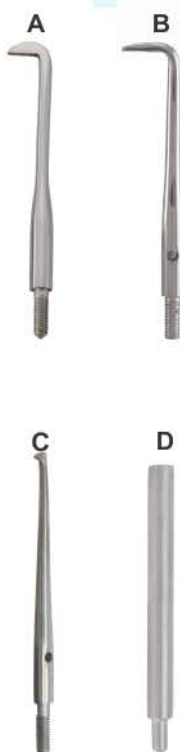

Article# W14-153  
 Crown Remover  
 Set of 5 Pcs



Article# W14-154  
 Crown Remover  
 Set of 6 Pcs



Article# W14-155  
 Crown Spreader, Crown Remover  
 Special Instrument for crown spreading after separating, simple and safe operation.

Инструменты для удаления коронок  
 Arrache-couronnes  
 Teleskopkronenzangen

Инструменти для видалення коронок  
 Arranca-corona  
 مزيلات الشاج



Article# WI4-156  
 Crown Remover,  
 For different level  
 of intensity



Article# WI4-157  
 Crown Remover,  
 For different level  
 of intensity

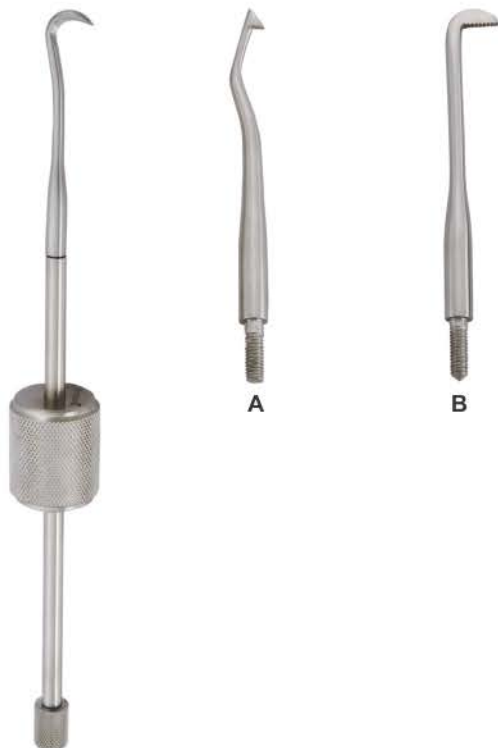

Article# WI4-158  
 Crown Remover  
 Set of 3 Pcs



Article# WI4-159  
 Set of 4 Pcs

- Матрицедержатели
- Porte Matrices
- Matrizenspanner
- Матрицеутримувачи
- Porta Matrices
- مصفوفة الخدم



**Article# WI4-160** Fig. 5 Ivory 8 5 mm  
**Article# WI4-161** Fig. 6 Ivory 8 6 mm  
**Article# WI4-162** Fig. 7 Ivory 8 7 mm  
**Article# WI4-163** Ivory 8 N  
**Article# WI4-164** Didner 8 P  
**Article# WI4-165** Didner 8 P 70 mm  
**Article# WI4-166** Matrix Ivory 8 6 mm



**Article# WI4-167** Fig. 1 Tofflemire-Universal  
**Article# WI4-168** Fig. 2 Tofflemire-Junior  
**Article# WI4-169** Fig. 3 Tofflemire-Senior  
**Article# WI4-170** Nyström Left  
**Article# WI4-171** Nyström Right  
**Article# WI4-172** Narrow  
**Article# WI4-173** Wide  
**Article# WI4-174** Ivory with shields  
**Article# WI4-175** Ivory without shields

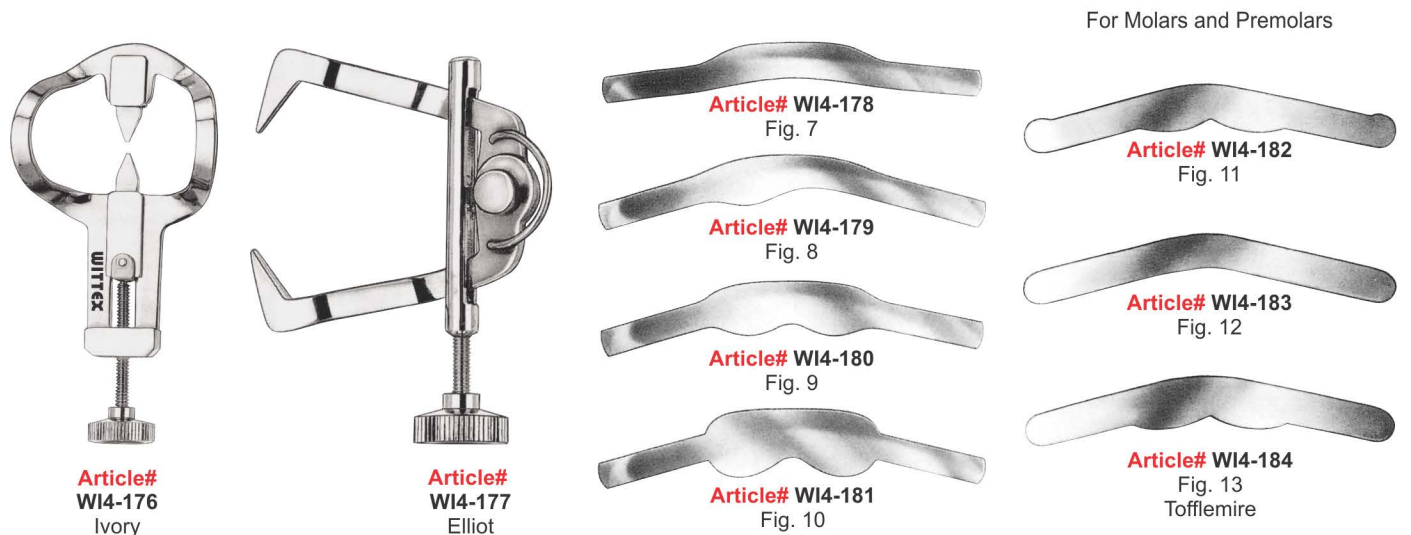

For Molars and Premolars

**Article# WI4-176**  
Ivory

**Article# WI4-177**  
Elliot

**Article# WI4-178**  
Fig. 7

**Article# WI4-179**  
Fig. 8

**Article# WI4-180**  
Fig. 9

**Article# WI4-181**  
Fig. 10

**Article# WI4-182**  
Fig. 11

**Article# WI4-183**  
Fig. 12

**Article# WI4-184**  
Fig. 13  
Tofflemire

- Инструменты для имплантологии
- Инструменти для імплантології
- Implantologie
- Implantoloia
- Implantologie
- زراعة الأسنان

MTA



Article# WI4-185  
0.8mm



Article# WI4-186  
1mm



Article# WI4-187  
1.2mm



Article# WI4-188  
1.8mm



Article# WI4-189  
Harvard Application Forceps



Cement Teeth Filling Plugger Applicator  
Carrier Root Canal Endodontic  
Material 0.8/1.0/1.2/1.8/2.0/2.8/3.5mm



Article# WI4-190



Article# WI4-191



Article# WI4-192



Article# WI4-193



Article# WI4-194

■ Инструменты для амальгамы ■ Инструменти для амальгами  
■ Instruments pour amalgame ■ Instrumentos para amalgama  
■ Amalgamisinstrumente ■ الصكوك الملعقم

ENDO AND ENDO MICRO SURGERY KITS

Ø 2mm



**Article# WI4-195**  
Fig. 10  
16.5cm  
English pattern

Ø 2mm



**Article# WI4-196**  
Fig. 1  
18.5cm  
German pattern

Ø 2mm



**Article# WI4-197**  
Fig. 1  
15cm  
Swiss pattern

Ø 2mm



**Article# WI4-198**  
Fig. 1  
15cm

Ø 2mm



**Article# WI4-199**  
Fig. 2  
15cm, 45°

Ø 2mm



**Article# WI4-200**  
Fig. 3  
14cm, 90°



**Article# WI4-201**  
Chip Blower



**Article# WI4-202**



**Article# WI4-203**



**Article# WI4-204**



**Article# WI4-205**  
Water Syringe

Инструменты для амальгамы    Инструменти для амальгами  
 Instruments pour amalgame    Instrumentos para amalgama  
 Amalgamisinstrumente    الصكوك الملقم

AMALGAM CARRIERS

TIP SIZES FOR DISTAL OR SINGLE-END

1.5 mm      2.0 mm

Article# W14-210 Mini/Single-End 2.8 mm

Article# W14-211 Regular Single-End 1.5 mm

Article# W14-212 Large Single-End 2.0 mm

Article# W14-214 Mini Distal

TIP SIZES FOR DOUBLE-END

1.5 mm      2.8 mm      3.2 mm

Article# W14-215 Mini/Regular 2.0 mm

Article# W14-216 Large/Regular 2.0 mm

Article# W14-217 Jumbo/Regular 2.0 mm

Article# W14-206 - 1.5mm  
 W14-207 - 2.0mm  
 W14-208 - 2.0mm  
 W14-209 - 3.0mm

Single-End

Article# W14-213 Regular Distal



Article# W14-230 Amalgam Well

TIP SIZES FOR DOUBLE-END

Article# W14-218 - 1.5mm-2.0mm  
 W14-219 - 2.0mm-2.8mm  
 W14-220 - 2.0mm-3.2mm

Article# W14-221 - 1.5mm-2.0mm  
 W14-222 - 2.0mm-2.8mm  
 W14-223 - 2.0mm-3.2mm

Article# W14-224 - 1.5mm-2.0mm  
 W14-225 - 2.0mm-2.8mm  
 W14-226 - 2.0mm-3.2mm

Article# W14-227 - 1.5mm-2.0mm  
 W14-228 - 2.0mm-2.8mm  
 W14-229 - 2.0mm-3.2mm



Article# W14-231 Stainless Steel Amalgam Well Medium



Article# W14-232 Stainless Steel Amalgam Well large

ENDO AND ENDO MICRO SURGERY KITS

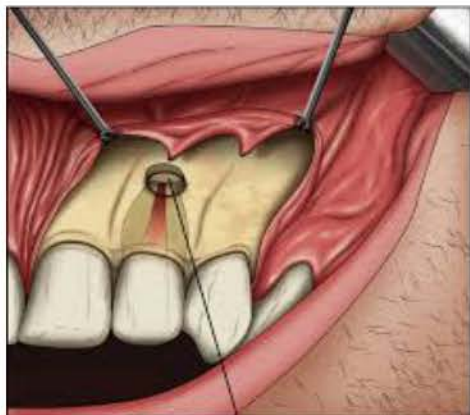











©Association of Oral and Maxillofacial Surgeons of India



Root Canal Treatment



-  **Article#** W14-233 Explorer Dg16
-  **Article#** W14-234 Anterior curette
-  **Article#** W14-235 Posterior curette
-  **Article#** W14-236 Excavator
-  **Article#** W14-237 Long excavator
-  **Article#** W14-238 Periosteal elevator, sharp
-  **Article#** W14-239 Periosteal Elevator
-  **Article#** W14-240 Periosteal Elevator PRICHARD
-  **Article#** W14-241 Retro Plugger Ø 0,5 mm Length of the tip 4,5 mm
-  **Article#** W14-242 Retro Plugger Ø 0,75 mm Length of the tip 4,5 mm
-  **Article#** W14-243 Modeller instrument Ball burnisher/Carver Ø 0,25 mm
-  **Article#** W14-244 MTA delivery / carver instrument
-  **Article#** W14-245 Rhodium 5 Ø 24 mm Mouth mirror handle
-  **Article#** W14-249 3 x 6 mm Micro mouth mirrors
-  **Article#** W14-250 Ø 5 mm Micro mouth mirrors



**Article#** W14-246 Perry 9cm



**Article#** W14-247 MTA Block



**Article#** W14-248 Retractor



**Article#** W14-251 Endomicro Surgery Kit with Cassette 19 Pcs

Apicoectomy Treatment Stages:

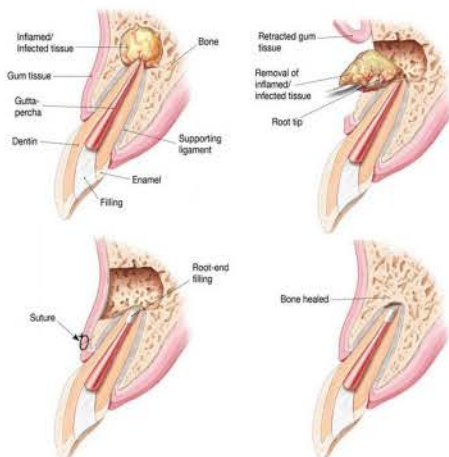

Apicoectomy on upper front tooth

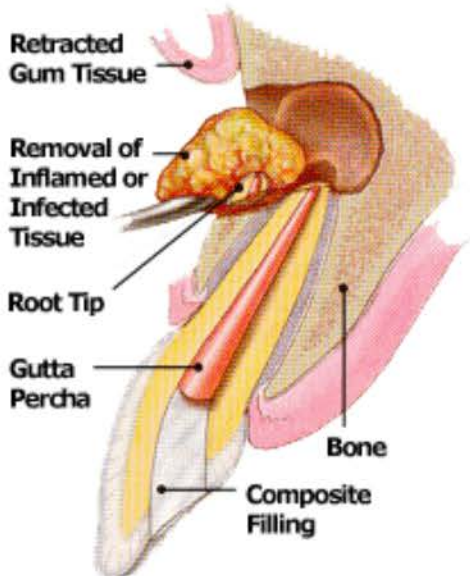

Micro apical surgery by SIE kit

Apical surgery is an option for the management of endodontically-treated tooth with persistent periapical lesions or symptom/sign. Several epidemiological studies have suggested that 33–60% of endodontically-treated teeth still presented the pictures of apical periodontitis. The possible causes may be persistent primary infection, secondary infection after endodontic therapy, vertical root fracture or cemental tears. The success rate of apical surgery was reported to range from 37% to 91%. Complete apical healing had been observed in 37%–96% of the endodontically-treated teeth after apical surgery.<sup>9</sup> The wide range and inconsistency of the results may be attributed to the variation in treatment planning, surgical technique, methodology, and follow-up period.

Patient presented with moderate pain on percussion related to tooth 22. Upon radiographic and clinical examination we've found an apical lesion related to this tooth with normal PDL probing. The patient has done the RCT 15 years ago with the full arch prosthetic crowns that looks fine and healthy. So we discussed with the patient the different treatment plans and we suggest the micro apical surgery to be done for more conservative approach rather than removing the crown, post, Re-RCT, new post and new crown. The procedure was done in single visit compared to the multiple visits in the non surgical approach. The patient was very happy for her smile, so she wants to keep everything as it is, this could be accomplished by the surgical approach as well.

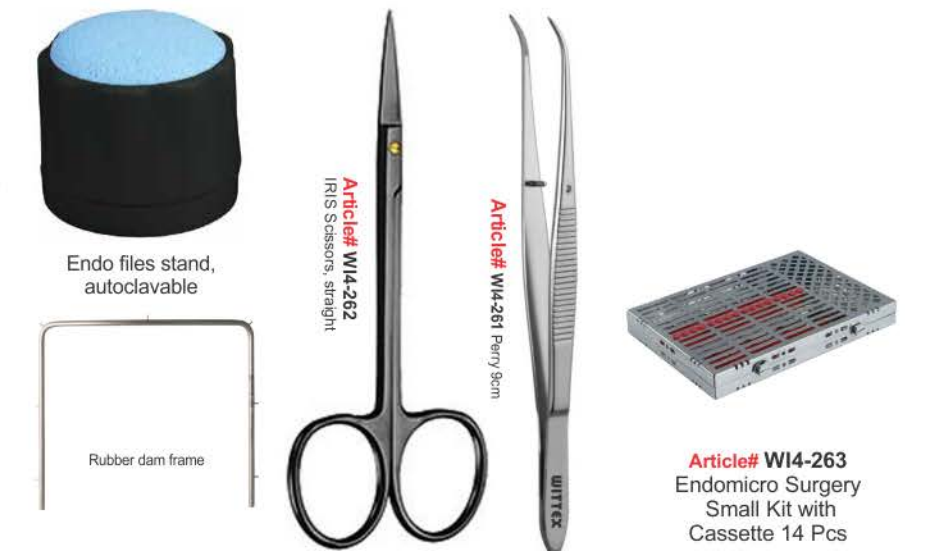
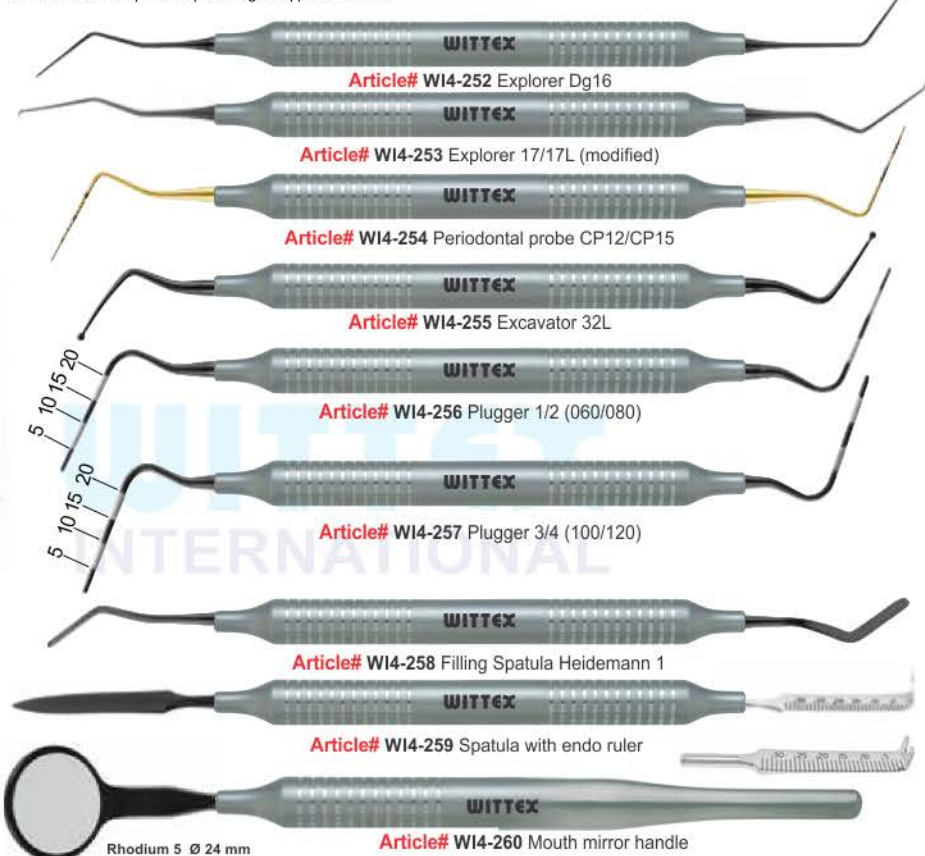

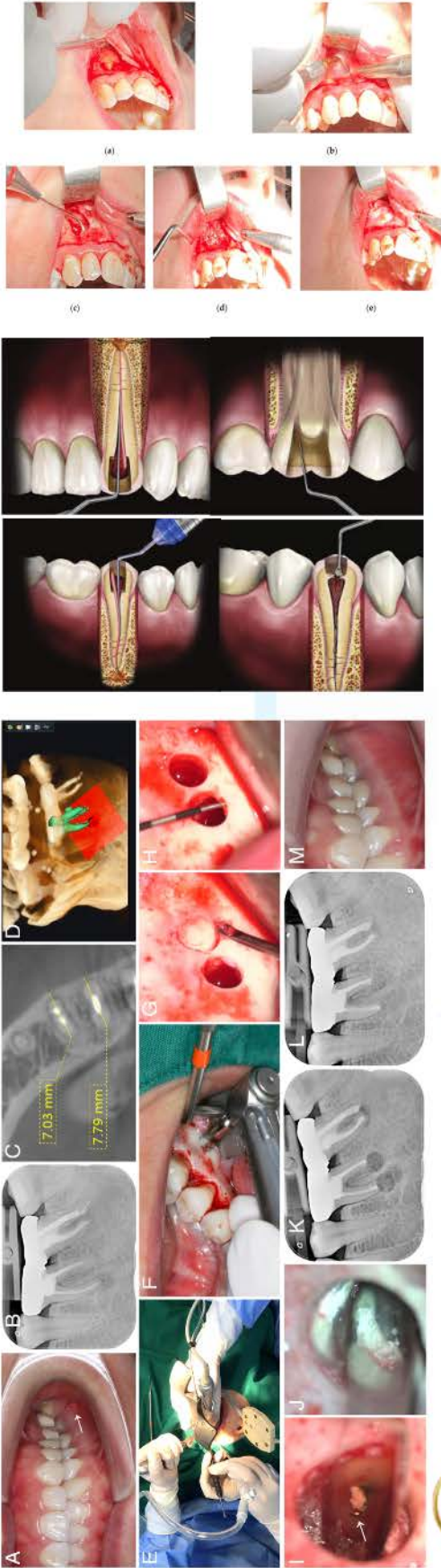

**Article# W14-278**  
Endomicro Surgery Small Kit  
with Cassette 15 Pcs



**Article# W14-274**  
Needle holder Microvascular  
with TC inserts



**Article# W14-275** Scalpel Handle Tip 16 cm Blade  
Size 18, 20, 21, 22, 23, 24, 25, 60, 70



**Article# W14-276**  
De Baky Atraumatic 15cm Straight



**Article# W14-277**  
IRIS Scissors,  
straight 9cm

**ENDO-DONTICS  
SECTION 4**

**INSTRUMENTS SET FOR ENDODONTIC SURGERY**

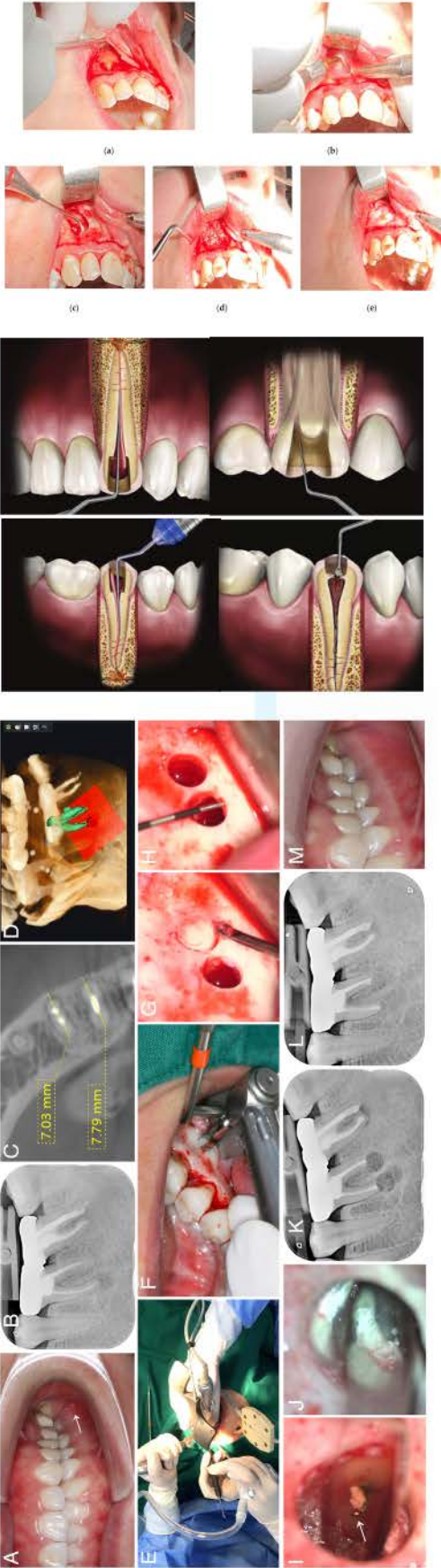

- Jx1 **WITTEX** Jx2  
**Article# W14-279** Endo Explorer (small size)
- JEX **WITTEX** JPP  
Endo Explorer (large size) **Article# W14-280** Periodontal Probe
- Jx5 **WITTEX**  
**Article# W14-281** Dental Mirror
- Je1 **WITTEX** Je2  
Size: 4,5mm **Article# W14-282** Incisors & Elevators Size: 5,5mm
- Je3 **WITTEX** Je4  
Size: 6,0 mm **Article# W14-283** Incisors & Elevators Size: 4.0 mm
- Jc1 **WITTEX** Jc2  
**Article# W14-284** Curettes
- Jc3 **WITTEX** Jc4  
**Article# W14-285** Curettes
- Jc9 **WITTEX** Jc10  
Size: 4 mm **Article# W14-286** Curettes Size: 3 mm
- Jc11 **WITTEX** Jc12  
Size: 4 mm **Article# W14-287** Curettes Size: 4 mm
- Jc13 **WITTEX** Jc14  
Size: 2 mm **Article# W14-288** Curettes Size: 2 mm
- Jc15 **WITTEX** Jc16  
Size: 1.5 mm **Article# W14-289** Curettes Size: 1.5 mm
- Jm1 **WITTEX** Jm2  
Size: 2mm **Article# W14-290** Retrofilling Carriers Size: 4mm
- Jm3 **WITTEX** Jm4  
**Article# W14-291** Retrofilling Carriers
- Jb1\* **WITTEX** Jb2  
Size: 1,3 mm **Article# W14-292** Ball Burnishers Size: 1,4 mm
- Jp2 **WITTEX** Jp3  
Size: ø 0,25mm **Article# W14-293** Micropluggers Size: ø 0,50mm
- Jp8 **WITTEX** Jp9  
Size: ø 0.75 mm **Article# W14-294** Micropluggers Size: ø 0.75 mm

**ENDO-DONTICS  
SECTION 4**

**INSTRUMENTS SET FOR ENDODONTIC SURGERY**



(a)

(b)



(c)

(d)

(e)

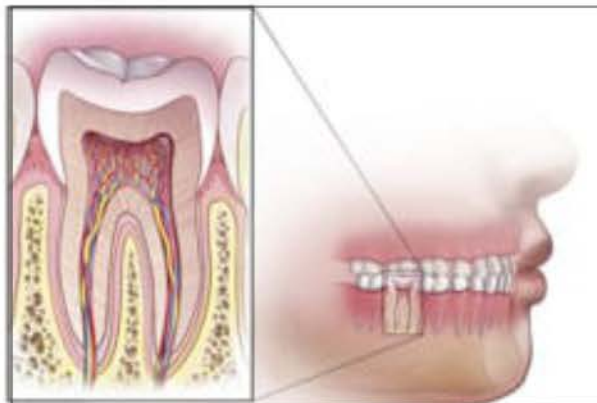
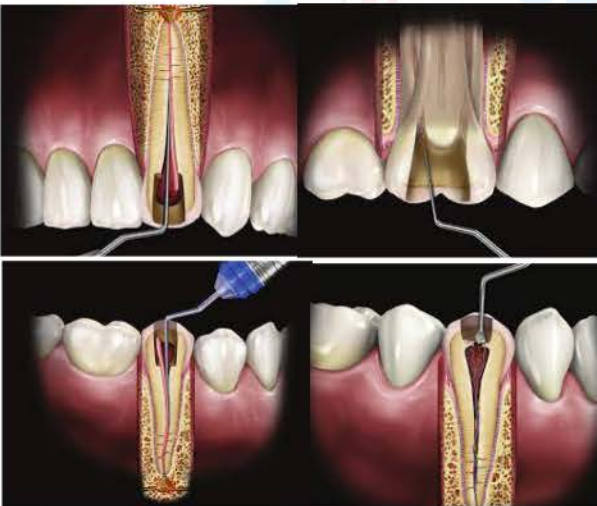
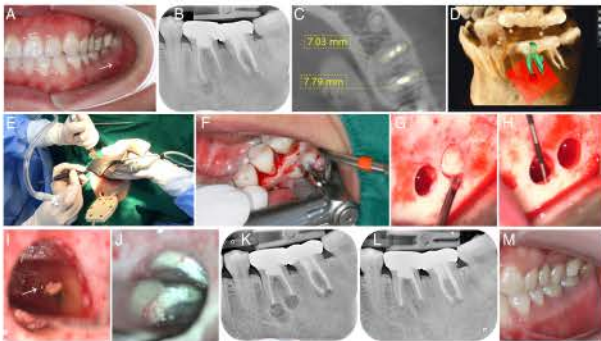

**WITTEX**

Article# W14-295 Micro Mirror

**WITTEX**

Article# W14-296 Micro Mirror

**WITTEX**

Article# W14-297 Micro Mirror

**WITTEX**

Article# W14-298 Micro Mirror

MTAP



Article# W14-299 MTA Carrier



Article# W14-300

Potts-Smith Tissue Forceps 1x2 teeth 18 cm straight



Article# W14-301

Potts-Smith Tissue Forceps 1x2 teeth 18cm curved



Article# W14-302

Castroviejo Microsurgery Scissors-18cm



Article# W14-303

Castroviejo Microsurgery Scissors-18cm



Article# W14-304

Microsurgical Needle Holder Str-18cm



Article# W14-305

Huey plier, diamond coated



Article# W14-306

micro pliers with delicate flat tips, 90° and 45°



Article# W14-307

Pin holding and nervebroaches plier



Article# W14-308

Endo Micro Surgery  
Complete Kit with Cassette 30 Pcs



FUNCTION OF ROOT ELEVATORS IN SURGERY

To Loosen Tooth or Root From Bony Socket Prior to Placement of The Extraction Forceps.

ROOT ELEVATORS

HANDLES FOR ROOT ELEVATORS POINTS A, B, C, D, E, F, G, H

Thumb Handle



Shortblast Handle



Half Gold Handle



Round With Edge Handle



Thom with Flat Handle



Eye Style Handle



Eye Style Handle



Grip Style Handle

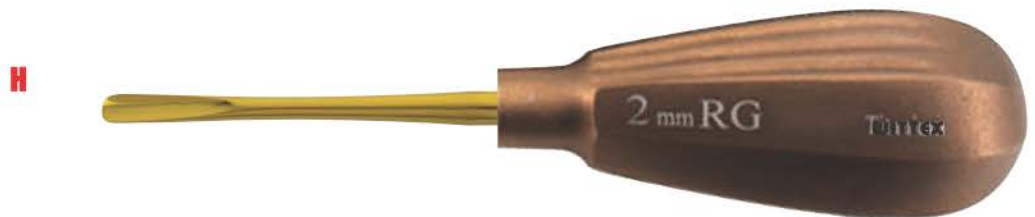

FUNCTION OF ROOT ELEVATORS IN SURGERY

To Loosen Tooth or Root From Bony Socket Prior to Placement of The Extraction Forceps.

Dental Root Elevators

To look at one of these instruments you might mistake it for a narrow screwdriver.

That's because just like one an elevator has a handle and then a specially designed "blade" or tip portion.

How they're used.

The tip of an elevator is designed to be wedged into the ligament space between a tooth and its surrounding bone (as shown in our animation).

As the elevator is forced into and twisted around in this space, the tooth is rocked around and pressed against the walls of its socket.

This helps to both expand the shape of the socket and separate the tooth from its ligament.

As this work is continued, the tooth gradually becomes more and more mobile.

In some cases, the dentist may be able to completely remove the tooth just using their elevator.

If not, they will choose a point where they feel they have accomplished as much as they can with it and will then switch to using extraction forceps.



**ROOTELEVATOR  
SECTION 5**

- Элеватор корневой экстракционный
- Elévateurs à racines
- Wurzelheber
- Слеватор корневий екстракційний
- Elevadores para raíces
- المصاعد الجذر

**Article# WI5-001 LUXATOR ROOT ELEVATORS SET OF 6 PCS**

**FUNCTION:** To Loosen Tooth or Root From Bony Socket Prior to Placement of The Extraction Forceps.



**Article# WI5-002**  
Luxator  
3mm  
straight

Luxator  
Root Elevator



**Article# WI5-003**  
Luxator  
4mm  
straight



**Article# WI5-004**  
Luxator  
5mm  
straight



**Article# WI5-005**  
Luxator  
3mm  
curved



**Article# WI5-006**  
Luxator  
4mm  
curved



**Article# WI5-007**  
Luxator  
5mm  
curved

ROOT ELEVATORS

**Article# WI5-008 LUXATOR ROOT ELEVATORS SET OF 8 PCS**

**FUNCTION:** To Loosen Tooth or Root From Bony Socket Prior to Placement of The Extraction Forceps.



**Article# WI5-009**  
Luxator  
2mm  
straight

Luxator  
Root Elevator



**Article# WI5-010**  
Luxator  
3mm  
straight



**Article# WI5-011**  
Luxator  
4mm  
straight



**Article# WI5-012**  
Luxator  
5mm  
straight



**Article# WI5-013**  
Luxator  
2mm  
curved



**Article# WI5-014**  
Luxator  
3mm  
curved



**Article# WI5-015**  
Luxator  
4mm  
curved



**Article# WI5-016**  
Luxator  
5mm  
curved

**Article# WI5-017 LUXATOR ROOT ELEVATORS SET OF 6 PCS**

**FUNCTION:** To Loosen Tooth or Root From Bony Socket Prior to Placement of The Extraction Forceps.



**Article# WI5-018**  
Luxator  
2mm  
straight

Luxator  
Root Elevator



**Article# WI5-019**  
Luxator  
3mm  
straight



**Article# WI5-020**  
Luxator  
4mm  
straight



**Article# WI5-021**  
Luxator  
2mm  
curved



**Article# WI5-022**  
Luxator  
3mm  
curved



**Article# WI5-023**  
Luxator  
4mm  
curved

**ROOTELEVATOR  
SECTION 5**

- Элеватор корневой экстракционный
- Єлеватор коренвий екстракційний
- Elévateurs à racines
- Elevadores para raíces
- Wurzelheber
- المصاعد الجذر

**Function of Root Elevators:**

To loosen tooth or root from bony socket prior to placement of the extraction forceps.

**ROOT ELEVATORS**



**Article# WI5-024**  
Luxating Elevators  
1.5mm, Straight



**Article# WI5-025**  
Luxating Elevators  
2mm, Straight



**Article# WI5-026**  
Luxating Elevators  
2mm, Curved



**Article# WI5-027**  
Luxating Elevators  
3mm, Straight



**Article# WI5-028**  
Luxating Elevators  
3mm, Curved



**Article# WI5-029**  
Luxating Elevators  
3mm, Double Curved



**Article# WI5-030**  
Luxating Elevators  
3mm, Curved Up



**Article# WI5-031**  
Luxating Elevators  
4mm, Straight



**Article# WI5-032**  
Luxating Elevators  
4mm, Curved



**Article# WI5-033**  
Luxating Elevators  
5mm, Straight



**Article# WI5-034**  
Luxating Elevators  
5mm, Curved

This section includes the Luxating Elevator set with Stainless Steel Handle. Long & light weight handle design provide excellent smooth grip with controlled force transfer. The working procedure is similar as mentioned in the previous section.

ROOTELEVATOR SECTION 5

- Элеватор корневой экстракционный
- Слеватор корневий екстракційний
- Elévateurs à racines
- Elevadores para raíces
- Wurzelheber
- المصاعد الجذر

FUNCTION OF ROOT ELEVATORS IN SURGERY



LUXATING ELEVATORS STR.

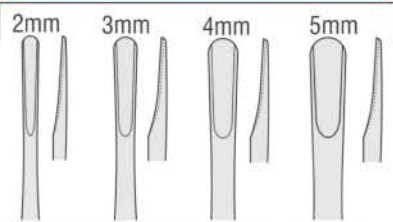

- Article# WI5-035   Article# WI5-036   Article# WI5-037   Article# WI5-038

LUXATING ELEVATORS CVD.

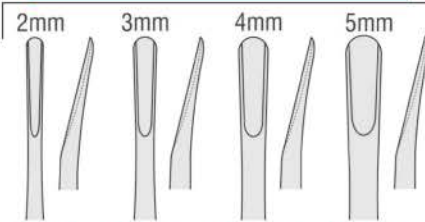

- Article# WI5-039   Article# WI5-040   Article# WI5-041   Article# WI5-042

LUXATING ELEVATORS ANGLED

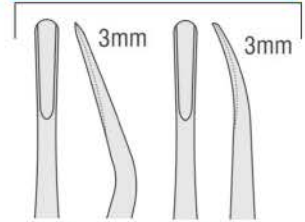

- Article# WI5-043   Article# WI5-044

**Function of Root Elevators:**  
To loosen tooth or root from bony socket prior to placement of the extraction forceps.



INTERNATIONAL

BEIN ELEVATORS ROUND TIPS STR.

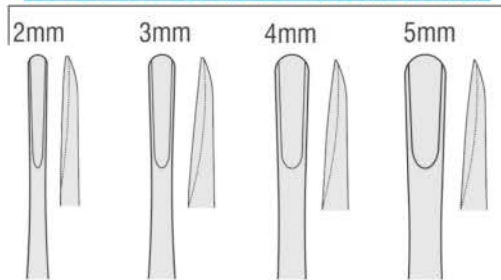

- Article# WI5-045   Article# WI5-046   Article# WI5-047   Article# WI5-048

BEIN ELEVATORS ROUND TIPS CVD.

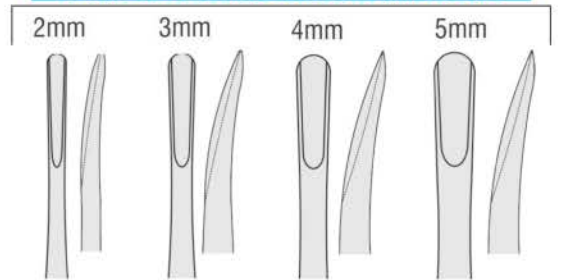

- Article# WI5-049   Article# WI5-050   Article# WI5-051   Article# WI5-052



Upper root elevator with helicoidal tip

lower roots elevator

universal mini-elevator for fragments

**Function of Root Elevators:**  
To loosen tooth or root from bony socket prior to placement of the extraction forceps.

ROOTELEVATOR SECTION 5

- Элеватор корневой экстракционный
- Слеватор корневий екстракційний
- Elévateurs à racines
- Elevadores para raíces
- Wurzelheber
- المصاعد الجذر

BEIN ELEVATORS POINTED TIPS STR.

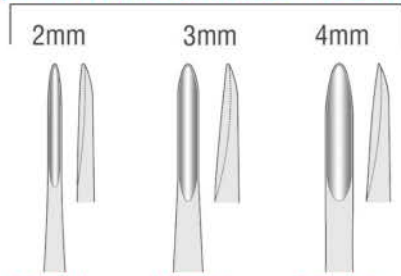

Article# WI5-053  
Article# WI5-054  
Article# WI5-055



BEIN ELEVATORS POINTED TIPS CVD.

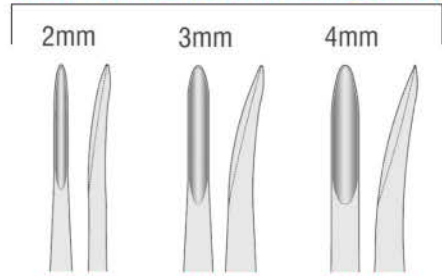

Article# WI5-056  
Article# WI5-057  
Article# WI5-058

**Function of Root Elevators:**  
To loosen tooth or root from bony socket prior to placement of the extraction forceps.

ROOT ELEVATORS

Straight

Curved



Article# WI5-059 Bein Root Elevator  
Article# WI5-060 Bein Root Elevator  
Article# WI5-061 Bein Root Elevator  
Article# WI5-062 Bein Root Elevator



upper root elevator



Article# WI5-063 Bein Root Elevator  
Article# WI5-064 Bein Root Elevator  
Article# WI5-065 Bein Root Elevator  
Article# WI5-066 Bein Root Elevator

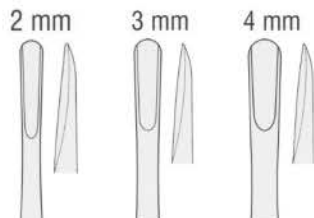

Article# WI5-068 Bein 3mm  
Article# WI5-069 Bein 4mm



Upper root elevator with helicoidal tip



Article# WI5-067 Bein 2mm

Bein Root Elevator

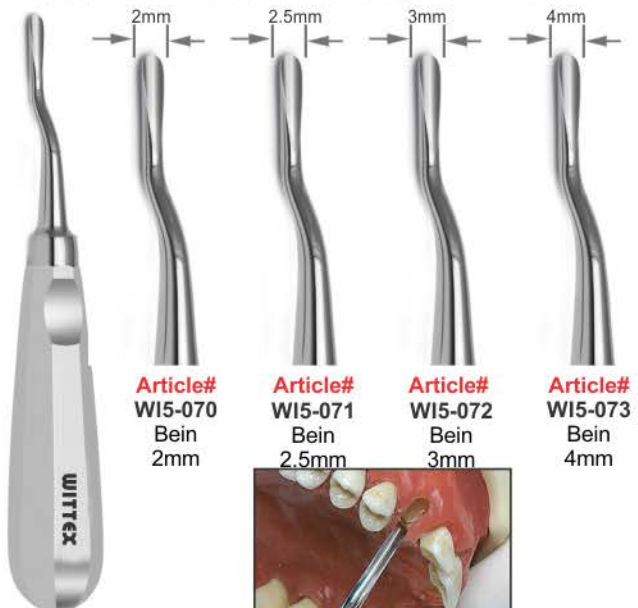

Article# WI5-070 Bein 2mm  
Article# WI5-071 Bein 2.5mm  
Article# WI5-072 Bein 3mm  
Article# WI5-073 Bein 4mm

Bein Root Elevator



upper root elevator

Элеватор корневой экстракционный / Слеватор коренвий екстракційний / Elévateurs à racines / Elevadores para raíces

**Function of Root Elevators:**

To loosen tooth or root from bony socket prior to placement of the extraction forceps.

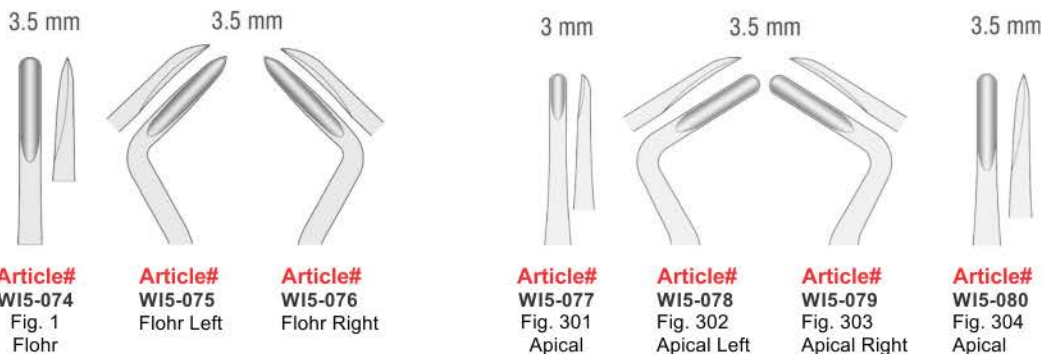

**Function of Root Elevators:**

To loosen tooth or root from bony socket prior to placement of the extraction forceps.

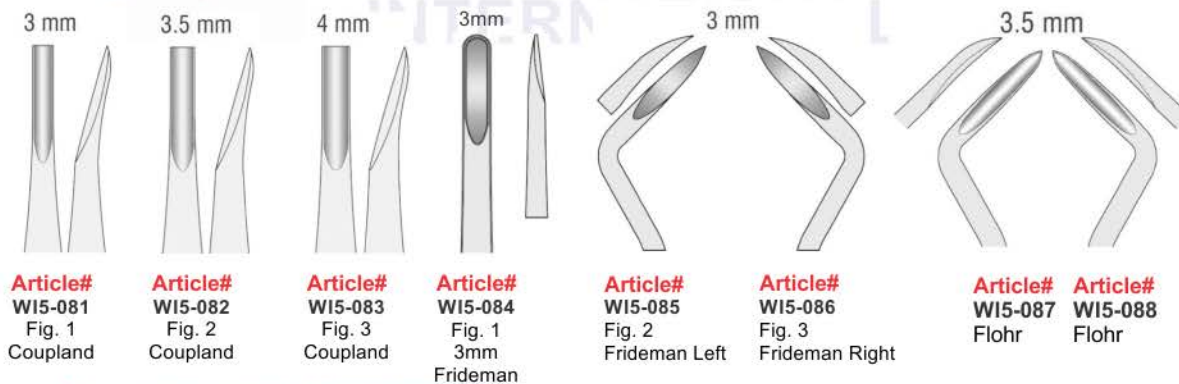

**Apical Elevators**  
Apical root elevators, right, left  
For upper and lower root tips  
Width of tip 3 mm  
Smooth Surface Handle  
Surgical Stainless Steel  
Sterilized in all Commercial Sterilizers



- Элеватор корневой экстракционный
- Elévateurs à racines
- Wurzelheber
- Слеватор корневий екстракційний
- Elevadores para raíces
- المصاعد الجذر

**Function of Root Elevators:**

To loosen tooth or root from bony socket prior to placement of the extraction forceps.



<b>Article#</b> WI5-092 5 Schmeckeblie Apexo	<b>Article#</b> WI5-093 71 Miller Apexo	<b>Article#</b> WI5-094 72 Miller Apexo	<b>Article#</b> WI5-095 6 Potts For impacted upper 3rd Molars without bony obstruction.	<b>Article#</b> WI5-096 7 Potts	<b>Article#</b> WI5-097 73 Miller Apexo	<b>Article#</b> WI5-098 74 Miller Apexo	<b>Article#</b> WI5-099 19 Shorter leverage for lower 1st and 2nd Molar roots. Also useful for premolar and molar deciduous teeth.	<b>Article#</b> WI5-100 20	



**Article# WI5-091**  
4 Schmeckeblie Apexo  
Schmeckeblie and Miller  
designs used for displacement  
of broken or deep-seated root tips.

WITTEX INTERNATIONAL

ROOT ELEVATORS



- |   |   |                                |                                |  |  |
|---|---|--------------------------------|--------------------------------|--|--|
| <b>Article#</b> WI5-101<br>38<br>Serrated | <b>Article#</b> WI5-102<br>39<br>Serrated | <b>Article#</b> WI5-103<br>190 | <b>Article#</b> WI5-104<br>191 | <b>Article#</b> WI5-105<br>15<br>Woodward<br>Lower Molar roots | <b>Article#</b> WI5-106<br>16<br>Woodward<br>Lower Molar roots |
|---|---|--------------------------------|--------------------------------|--|--|

For removal of root fragments

ROOTELEVATOR SECTION 5

- Элеватор корневой экстракционный
- Слеватор корневий екстракційний
- Elévateurs à racines
- Elevadores para raíces
- Wurzelheber
- المصاعد الجذر



Cryer root or fragment elevator



Seldin root or fragment elevator

**Function of Root Elevators:**  
To loosen tooth or root from bony socket prior to placement of the extraction forceps.

ROOT ELEVATORS



Medium Cryer Root Elevators set  
Left & Right, with medium working points  
Working Tips are smooth  
Smooth Surface Handle  
Surgical Stainless Steel  
Sterilized in all Commercial Sterilizers



Seldin root or fragment elevator



Cryer root or fragment elevator

Article# WI5-113  
**CRYER**  
44 Small

Large Cryer Root Elevators set  
Left & Right, with large working points  
Working Tips are smooth  
Smooth Surface Handle  
Surgical Stainless Steel  
Sterilized in all Commercial Sterilizers

- Элеватор корневой экстракционный
- Elevator corneviu extracționii
- Elévateurs à racines
- Elevadores para raíces
- Wurzelheber
- المصاعد الجذر

**Function of Root Elevators:**

To loosen tooth or root from bony socket prior to placement of the extraction forceps.

**LENDO-LEVIAN ELEVATORS STR.**



**LENDO-LEVIAN ELEVATORS CVD.**



ROOT ELEVATORS

These root elevators are used for releasing the ligaments around the neck of the tooth, and to facilitate the extraction. The working end serration can be very helpful during the initial phase of extraction.

Elevator according to Lindo-Levien  
Working part straight with serration  
Width 2.2mm 3.0mm or 4.0mm  
Smooth Surface Handle  
Surgical Stainless Steel  
Sterilized in all Commercial Sterilizers



Lindo-Levien Elevators

Upper root elevator with helicoidal tip

lower roots elevator



- Article# WI5-129  
Lindo-Levien Elevators  
3mm, Straight
- Article# WI5-130  
Lindo-Levien Elevators  
3mm, Curved
- Article# WI5-131  
Lindo-Levien Elevators  
4mm, Straight
- Article# WI5-132  
Lindo-Levien Elevators  
4mm, Curved

Article# WI5-133  
Heidbrink Left

Article# WI5-134  
Heidbrink Right

HEIDBRINK  
Root Tip Pick

Article# WI5-135  
Heidbrink Straight

- Элеватор корневой экстракционный
- Слеватор корневий екстракційний
- Elévateurs à racines
- Elevadores para raíces
- Wurzelheber
- المصاعد الجذر

**Coupland Elevators**

**Function of Root Elevators:**

*To loosen tooth or root from bony socket prior to placement of the extraction forceps.*

Coupland root elevators set 3mm, 3.5mm & 4mm tip width  
Sand Blasted no slip handle Surgical Stainless Steel  
Sterilized in all Commercial Sterilizers



1C Elevator Coupland 3mm Article# WI5-136    2C Elevator Coupland 3.5mm Article# WI5-137    3C Elevator Coupland 4mm Article# WI5-138    Schmeckebier Apexo Elevator L Article# WI5-139    Schmeckebier Apexo Elevator R Article# WI5-140    6 Potts Elevator Article# WI5-141    7 Potts Elevator Article# WI5-142

**Seldin Elevators**

Seldin root elevators Smooth Surface Handle  
Surgical Stainless Steel Sterilized in  
all Commercial Sterilizers

**B-Cogswell & Apexo Elevators**

Smooth Surface Handle Surgical  
Stainless Steel Sterilized in  
all Commercial Sterilizers

**Potts Elevators**

These root elevators are used for releasing the  
ligaments around the neck of the tooth, and to  
facilitate the extraction. The working end are  
smooth. These are used for impacted upper  
3rd Molars without bony obstruction.

**Elevator according to Potts**

Working Tips are smooth  
Smooth Surface Handle  
Surgical Stainless Steel  
Sterilized in all Commercial Sterilizers

**ROOT ELEVATORS**

**Wisdom Roots Elevator**



34 Str. Seldin Elevator, Upper and lower anterior roots

Article# WI5-143

3S Seldin Elevator, Upper & lower anterior roots, sharp cone edge

Article# WI5-144

2S Seldin Elevator, Lower 3rd Molars

Article# WI5-145

301 Apexo Elevator, for displacement of deeply seated roots

Article# WI5-146

B Cogswell Elevator

Article# WI5-147

Article# WI5-148  
Wisdom for 28 and 48

Article# WI5-149  
Wisdom for 18 and 38

ROOTELEVATOR SECTION 5

- Элеватор корневой экстракционный
- Elévateurs à racines
- Wurzelheber
- Слеватор корневий екстракційний
- Elevadores para raices
- المصاعد الجذر



<b>Article#</b> <b>WI5-150</b> 46	<b>Article#</b> <b>WI5-151</b> 77	<b>Article#</b> <b>WI5-152</b> 77R	<b>Article#</b> <b>WI5-153</b> 46R	<b>Article#</b> <b>WI5-154</b> 92	<b>Article#</b> <b>WI5-155</b> 93	<b>Article#</b> <b>WI5-156</b> 51	<b>Article#</b> <b>WI5-157</b> 52
Upper posterior Roots	Serrated Upper posterior Roots and upper 3rd molars	Serrated	Upper posterior roots	Serrated	Serrated	Curtis	Curtis

Upper and lower molar roots **Function of Root Elevators:**  
*To loosen tooth or root from bony socket prior to placement of the extraction forceps.*

<b>Article#</b> <b>WI5-159</b> 34	<b>Article#</b> <b>WI5-160</b> 2S	<b>Article#</b> <b>WI5-161</b> 3S	<b>Article#</b> <b>WI5-162</b> 8	<b>Article#</b> <b>WI5-163</b> 44C Bradley	<b>Article#</b> <b>WI5-164</b> A	<b>Article#</b> <b>WI5-165</b> B	
Upper and lower anterior roots	Lower 3rd Molars	Upper and lower anterior roots	Crane Pick	For displacement of roots and 3rd Molars	Cogswell	Cogswell	

**Article# WI5-158**  
34S  
Thinner tip and more narrow than the 34 shank

**Function of Root Elevators:**  
*To loosen tooth or root from bony socket prior to placement of the extraction forceps.*

Seldin root or fragment elevator  
3.5mm



Cryer root or fragment elevator



- |   |  |   |
|---|--|---|
| <b>Article#</b><br><b>WI5-166</b><br>Seldin | <b>Article#</b><br><b>WI5-167</b><br>11<br>Stout | <b>Article#</b><br><b>WI5-168</b><br>11A<br>Stout |
|   | 3rd Molars                                       | 3rd Molars  |

ROOT ELEVATORS

ROOTELEVATOR SECTION 5

- Элеватор корневой экстракционный
- Слеватор корневий екстракційний
- Elévateurs à racines
- Elevadores para raíces
- Wurzelheber
- المصاعد الجذر

**Function of Root Elevators:**

To loosen tooth or root from bony socket prior to placement of the extraction forceps.

Laxutor Root Elevators Set of 9 Pcs



Long Type



This section includes a comprehensive set of Posterior Flared Tip Elevators. These elevators used to loosen the tooth from the periodontal ligament and ease extraction, particularly used for Upper Posterior Roots and Upper 3rd Molar.

E46 & E46R: Mesial & Distal with 2.75mm, Smooth working tips

E77 & E77R: Mesial & Distal with 3.75mm, Serrated working tips

Surgical Stainless Steel Hollow handle, very light weight Completely Sterilizable

Article# W15-169  
2mm Str.



Posterior Flared Tip Elevators



Cryer root or fragment elevator



Luxating Elevator With Perioste Tip

ROOT ELEVATORS



- Элеватор корневой экстракционный
- Элеватор корневий екстракційний
- Elévateurs à racines
- Elevadores para raíces
- Wurzelheber
- المصاعد الجذر

**Function of Root Elevators:**

To loosen tooth or root from bony socket prior to placement of the extraction forceps.  
Kopp Roots Elevator

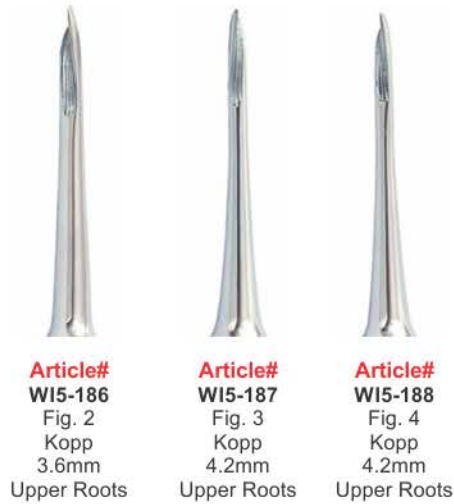

**Article# W15-186**  
Fig. 2  
Kopp  
3.6mm  
Upper Roots

**Article# W15-187**  
Fig. 3  
Kopp  
4.2mm  
Upper Roots

**Article# W15-188**  
Fig. 4  
Kopp  
4.2mm  
Upper Roots

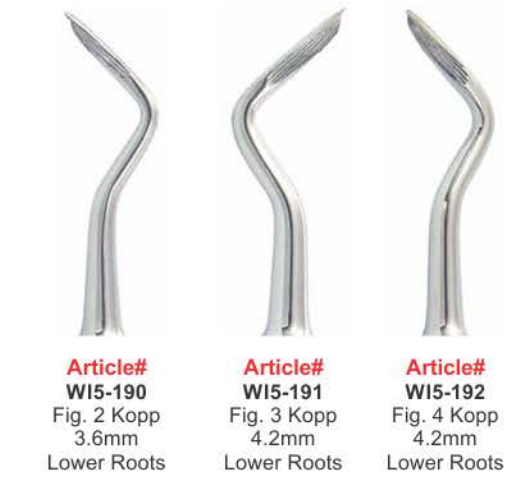

**Article# W15-190**  
Fig. 2 Kopp  
3.6mm  
Lower Roots

**Article# W15-191**  
Fig. 3 Kopp  
4.2mm  
Lower Roots

**Article# W15-192**  
Fig. 4 Kopp  
4.2mm  
Lower Roots



**Article# W15-185**  
Fig. 1  
Kopp 3.6mm Upper Roots

**Article# W15-189**  
Fig. 1 Kopp 3.6mm Lower Roots

Cryer root or fragment elevator

ROOT ELEVATORS



6.8 cm  
2.0 mm



Bein  
**Article# W15-193**

Bein  
**Article# W15-194**

Bein  
**Article# W15-195**

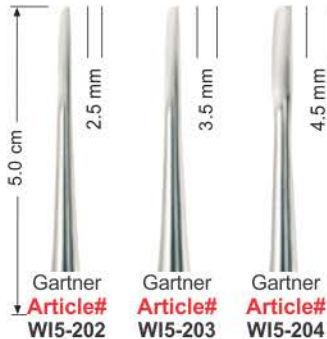

Gartner  
**Article# W15-202**

Gartner  
**Article# W15-203**

Gartner  
**Article# W15-204**

Bein  
**Article# W15-201**



**Article# W15-196**  
Fig. 301  
Apexo  
2.5mm



**Article# W15-197**  
Fig. 302  
Apexo  
2.5mm

**Article# W15-198**  
Fig. 303  
Apexo  
2.5mm

**Article# W15-199**  
Fig. 301W  
Seldin  
3mm

**Article# W15-200**  
Fig. 304W  
Seldin  
3mm



universal mini-elevator for fragments

ROOTELEVATOR SECTION 5

- Элеватор корневой экстракционный
- Слеватор корневий екстракційний
- Elévateurs à racines
- Elevadores para raíces
- Wurzelheber
- المصاعد الجذر

**Function of Root Elevators:**

To loosen tooth or root from bony socket prior to placement of the extraction forceps.

**Medan Roots Elevator**

**Hylin Roots Elevator**



<b>Article#</b> WI5-205	<b>Article#</b> WI5-206	<b>Article#</b> WI5-207	<b>Article#</b> WI5-208	<b>Article#</b> WI5-209	<b>Article#</b> WI5-210
ein 2.5mm	Bein 3mm Flat	Bein 3mm Round	Bein 3.5mm	Flohr 3.5mm (Left)	Flohr 3.5mm (Right)



<b>Article#</b> WI5-211	<b>Article#</b> WI5-212	<b>Article#</b> WI5-213
Hylin 4mm Str.	Hylin 3.5mm Left	Hylin 3.5mm Right



Cryer root or fragment elevator

**Medan Roots Elevator**

**Article# WI5-214**  
Hylin  
3mm  
Str.

Overall length  
154mm

**HEIDBRINK**



<b>Article#</b> WI5-216	<b>Article#</b> WI5-217	<b>Article#</b> WI5-218	<b>Article#</b> WI5-219	<b>Article#</b> WI5-220	<b>Article#</b> WI5-221	<b>Article#</b> WI5-222	<b>Article#</b> WI5-223	<b>Article#</b> WI5-224	<b>Article#</b> WI5-225	<b>Article#</b> WI5-226
303 Apexo	301W Seldin	304W Seldin	1 Heidbrink Straight	2 Heidbrink Straight	80	81	81A	81E	40 Heidbrink Straight	41 Heidbrink Straight

Upper and lower anterior teeth and roots  
Upper anterior For displacement of anterior roots and small teeth

Upper and lower anterior teeth and roots

Upper and lower anterior teeth and roots



Upper root elevator with helicoidal tip



lower roots elevator



universal mini-elevator for fragments

**Article# WI5-215**  
301 Apexo

For displacement of deeply seated roots

ROOT ELEVATORS

ROOTELEVATOR SECTION 5

- Элеватор корневой экстракционный
- Слеватор корневий екстракційний
- Elévateurs à racines
- Elevadores para raíces
- Wurzelheber
- المساعد الجذر

**Function of Root Elevators:**

To loosen tooth or root from bony socket prior to placement of the extraction forceps.



Root Elevators

<b>Article#</b> WI5-227 Bein 2mm round	<b>Article#</b> WI5-228 Bein 3mm round	<b>Article#</b> WI5-229 Bein 4mm round	<b>Article#</b> WI5-230 Bein 2mm Flat	<b>Article#</b> WI5-231 Bein 3mm Flat	<b>Article#</b> WI5-232 Bein 4mm Flat	<b>Article#</b> WI5-233 White 4mm	<b>Article#</b> WI5-234 White 4mm	
<b>Article#</b> WI5-235 Flohr 3mm	<b>Article#</b> WI5-236 Flohr 3mm	<b>Article#</b> WI5-237 Flohr 3mm Flat	<b>Article#</b> WI5-238 Flohr 3mm Flat	<b>Article#</b> WI5-239 Berten 5mm Lower roots	<b>Article#</b> WI5-240 3mm	<b>Article#</b> WI5-241 3mm	<b>Article#</b> WI5-242 3mm	<b>Article#</b> WI5-243 3mm

**FUNCTION:** To Loosen Tooth or Root From Bony Socket Prior to Placement of The Extraction Forceps.  
Mesial & Distal Root Elevators



Root Elevators

<b>Article#</b> WI5-244 Fig. 33 Mesial 2 mm	<b>Article#</b> WI5-245 Fig. 34 Mesial 3 mm	<b>Article#</b> WI5-246 Fig. 35 Mesial 4 mm	<b>Article#</b> WI5-247 Fig. 36 Distal 2 mm	<b>Article#</b> WI5-248 Fig. 37 Distal 3 mm	<b>Article#</b> WI5-249 Fig. 38 Distal 4 mm



ROOT ELEVATORS

**ROOTELEVATOR  
SECTION 5**

- Элеватор корневой экстракционный
- Elevator coronevii ekstraktsionnyi
- Elévateurs à racines
- Elevadores para raices
- Wurzelheber
- المصاعد الجذر

**Function of Root Elevators:**

*To loosen tooth or root from bony socket prior to placement of the extraction forceps.*

Bernard Root Elevators are particularly suitable for the excision of fractured roots or root fragments. They represent a combination of root tip elevators and luxating elevators. The inner side is concave and the laterals edges are for cutting. This allow for rotatory movements, and when applying slight pressure, the ligaments can be separated and the remaining root fragments can be loosened.

This section includes a set of five Bernard Root Elevators, including Left, Right, Straight, Mesial & Distal form. All elevators are made from, Surgical Stainless Steel Hallow handle, light weight Completely Sterilizable

Bernard Root elevators also know as Syndesmotomes. They can also be use as Periostome or to elevate Small Roots

**ROOT ELEVATORS**

<b>Distal Spade Root Tip Elevator</b>	<b>Mesial Spade Root Tip Elevator</b>	<b>Straight Spade Root Tip Elevator</b>	<b>Right Spade Root Tip Elevator</b>	<b>Left Spade Root Tip Elevator</b>
				
<b>Article# WI5-250</b>	<b>Article# WI5-251</b>	<b>Article# WI5-252</b>	<b>Article# WI5-253</b>	<b>Article# WI5-254</b>
Distal Spade Root Tip Elevator	Mesial Spade Root Tip Elevator	Straight Spade Root Tip Elevator	Right Spade Root Tip Elevator	Left Spade Root Tip Elevator

Bernard Elevators -Syndesmotomes

**Article# WI5-255 BAYONET ELEVATORS SET OF 7 PCS**

5 mm	3 mm	5 mm	5 mm	5 mm	5 mm	5 mm	5 mm	5 mm	5 mm	5 mm
										
<b>Article# WI5-256</b>	<b>Article# WI5-257</b>	<b>Article# WI5-258</b>	<b>Article# WI5-259</b>	<b>Article# WI5-260</b>	<b>Article# WI5-261</b>	<b>Article# WI5-262</b>	<b>Article# WI5-263</b>	<b>Article# WI5-264</b>	<b>Article# WI5-265</b>	<b>Article# WI5-265</b>
							7 Bernard Right #504	11 Bernard Straight #504	6 Bernard Left #504	

ROOTELEVATOR SECTION 5

- Элеватор корневой экстракционный
- Элеватор коренвий экстракційний
- Elévateurs à racines
- Elevadores para raices
- Wurzelheber
- المصاعد الجذر

**Function of Root Elevators:**

To loosen tooth or root from bony socket prior to placement of the extraction forceps.

Article# WI5-266

LUXATORS SET OF 9 PCS

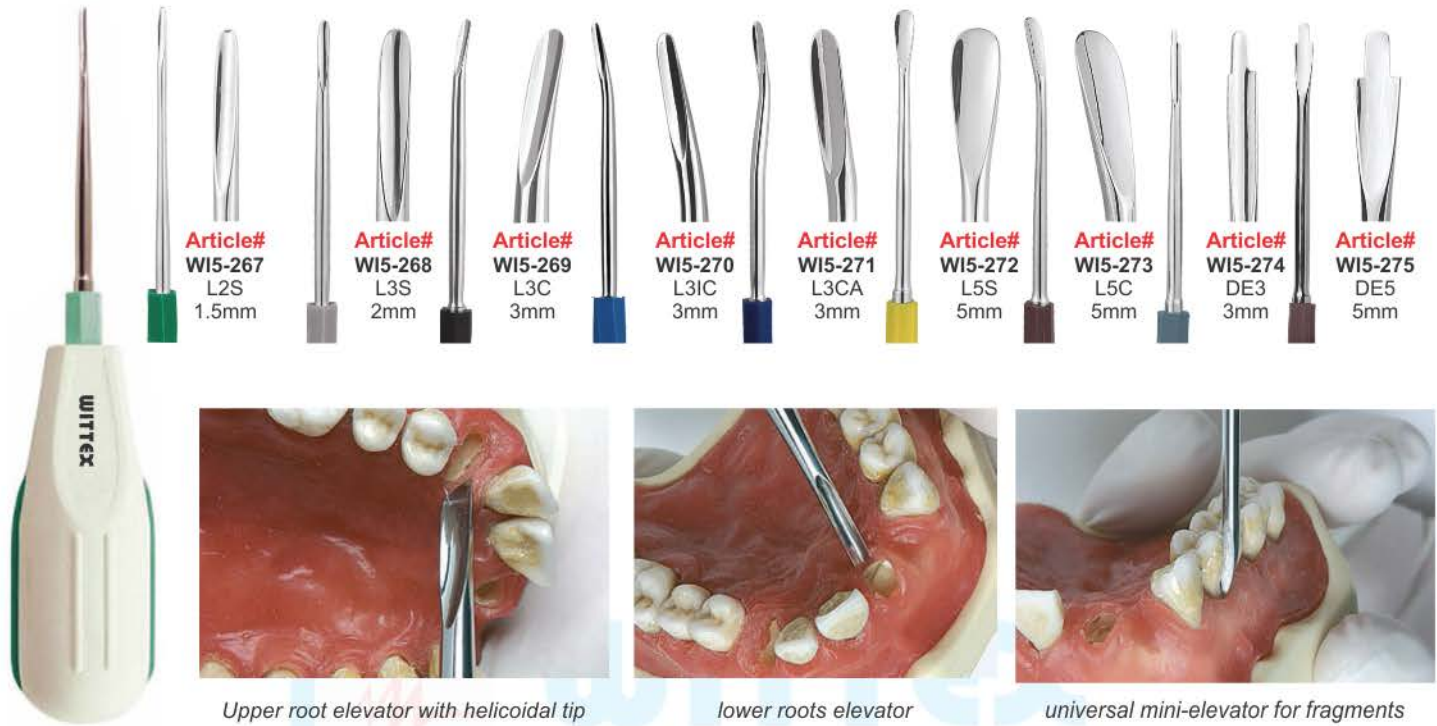

ROOT ELEVATORS

Article# WI5-276

LUXATORS SET OF 7 PCS



**ROOTELEVATOR  
SECTION 5**

- Элеватор корневой экстракционный    ■ Elevator corneviy ekstraktsionnyy
- Elévateurs à racines    ■ Elevadores para raíces
- Wurzelheber    ■ المصاعد الجذر

WI5-284

LUXATORS SET OF 4 PCS

Directa

Description:

The Luxator P-series offers good tactility and reach with the penholder grip. These instruments are thinner and sharper than the original Luxator instruments. Initiating the extraction process with the P-series range will simplify your work. Luxator P-series kit Contains: 4 different blade shapes: WI5-415 Luxator P1, straight blade, dark green - Straight universal periostome, ideal for anteriors and premolars. WI5-416 Luxator P2, curved blade, light blue - A slightly curved periostome for improved ergonomics. WI5-417 Luxator P3, contra angle blade, dark blue - Distal use, specially designed for use on posteriors. WI5-418 Luxator P4, dual edge blade, lilac - For fractured root tips and very decayed teeth



Article#  
WI5-285

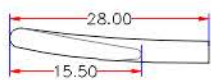

Article#  
WI5-286

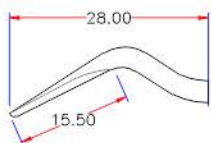

Article#  
WI5-287

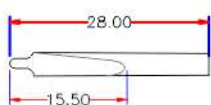

Article#  
WI5-288

Article# WI5-289 Luxating Elevators Set of 5 pcs

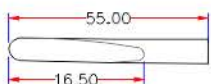

Article# WI5-290 Luxating Elevator #2, 3mm Straight

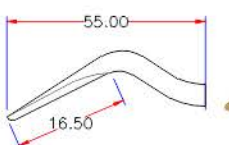

Article# WI5-291 Luxating Elevator #7, 3mm Double Curved



Article# WI5-292 Luxating Elevator #4, 3mm Curved



Article# WI5-293 Luxating Elevator #5, 5mm Curved

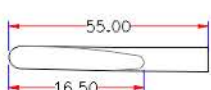

Article# WI5-294 Luxating Elevator #3, 5mm Straight

ROOT ELEVATORS

- Элеватор корневой экстракционный
- Elévateurs à racines
- Wurzelheber
- Слеватор корневий екстракційний
- Elevadores para raices
- المصاعد الجذر

**Function of Root Elevators:**

*To loosen tooth or root from bony socket prior to placement of the extraction forceps.*

LUXATORS SET OF 10 PCS MICRO SERRATED



<b>Article#</b> W15-296 Laxutor 1.5mm Str.	<b>Article#</b> W15-297 Laxutor 2mm Str.	<b>Article#</b> W15-298 Laxutor 3mm Str.	<b>Article#</b> W15-299 Laxutor 5mm Str.	<b>Article#</b> W15-300 Laxutor 3mm Cvd.	<b>Article#</b> W15-301 Laxutor 5mm Cvd.	<b>Article#</b> W15-302 Laxutor 3mm Upper Angle	<b>Article#</b> W15-303 Laxutor 3mm Double Angle	<b>Article#</b> W15-304 Laxutor 3mm Str.	<b>Article#</b> W15-305 Laxutor 5mm Str.
--	--	--	--	--	--	---	--	--	--

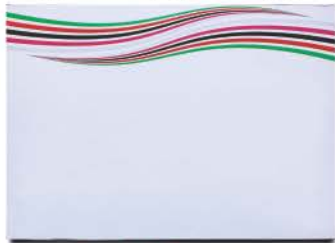

**Article# W15-295**  
LUXATORS SET OF 10 PCS  
MICRO SERRATED

**Article# W15-306**  
BEIN ROOT ELEVATORS  
SET OF 6 PCS

BEIN ROOT ELEVATORS SET OF 6 PCS



<b>Article#</b> W15-307 Bein 3S 3mm	<b>Article#</b> W15-308 Bein 3IC 2mm	<b>Article#</b> W15-309 Bein 3C 3mm	<b>Article#</b> W15-310 Bein 4C 4mm	<b>Article#</b> W15-311 Bein 5C 3mm	<b>Article#</b> W15-312 Bein 5CA 3mm
--	---	--	--	--	---

ROOT ELEVATORS

- Элеватор корневой экстракционный
- Элеватор корневий екстракційний
- Elévateurs à racines
- Elevadores para raíces
- Wurzelheber
- المصاعد الجذر

**Function of Root Elevators:**

To loosen tooth or root from bony socket prior to placement of the extraction forceps.



**Article# WI5-313**  
301  
Apexo



**Article# WI5-314**  
301  
Apexo  
Ergo Dynamic



**Article# WI5-315**  
#77R Elevator  
Serrated  
Ergo Dynamic



**Article# WI5-316**  
#B Cogswell  
Elevator  
Ergo Dynamic



**Article# WI5-317**  
#34S  
Seldin Elevator  
Straight  
Ergo Dynamic



**Article# WI5-318**  
Luxating Elevator  
Straight  
3mm  
Ergo Dynamic



**Article# WI5-319**  
Luxating Elevator  
Curved  
3mm  
Ergo Dynamic

ERGO DYNAMIC ELEVATORS OFFER AN ALTERNATIVE TO STANDARD SIZE ELEVATOR HANDLES.



**Article# WI5-320**  
Luxating Elevator  
Straight  
5mm  
Ergo Dynamic



**Article# WI5-321**  
Luxating Elevator  
Curved  
5mm  
Ergo Dynamic

INTERNATIONAL

LUXATOR ROOT ELEVATORS SET OF 6 PCS



**Article# WI5-322**



**Article# WI5-323**



**Article# WI5-324**



**Article# WI5-325**



**Article# WI5-326**



**Article# WI5-327**



**Article# WI5-328**  
Root Elevator Set of 6 Pcs

- Элеватор корневой экстракционный
- Elévateurs à racines
- Wurzelheber
- Слеватор корневий екстракційний
- Elevadores para raíces
- المصاعد الجذر

**Function of Root Elevators:**

*To loosen tooth or root from bony socket prior to placement of the extraction forceps.*

**FUNCTION:** To Loosen Tooth or Root From Bony Socket Prior to Placement of The Extraction Forceps.

**W. Barry Roots Elevator**



Article# WI5-329  
W. Barry  
Fig. 1

Article# WI5-330  
W. Barry  
Fig. 2

Article# WI5-331  
W. Barry  
Fig. 3

Article# WI5-332  
W. Barry  
Fig. 4



**Winter Roots Elevator**



Article# WI5-333  
Winter  
Fig. 1L

Article# WI5-334  
Winter  
Fig. 1R

Article# WI5-335  
Winter  
Fig. 11L

Article# WI5-336  
Winter  
Fig. 11R

Article# WI5-337  
Winter  
Fig. 12L

Article# WI5-338  
Winter  
Fig. 12R

**Pott Roots Elevator**



Article# WI5-339  
Winter  
Fig. 1L



Article# WI5-340  
Winter  
Fig. 1R



Article# WI5-341  
Lecluse  
bayonet



Article# WI5-342  
Pott  
Left



Article# WI5-343  
Pott  
Right

- Элеватор корневой экстракционный
- Elévateurs à racines
- Wurzelheber
- Слеватор корневий екстракційний
- Elevadores para raíces
- المصاعد الجذر

**Function of Root Elevators:**

*To loosen tooth or root from bony socket prior to placement of the extraction forceps.*

**FUNCTION:** To Loosen Tooth or Root From Bony Socket Prior to Placement of The Extraction Forceps.

**Heidbrink Roots Elevator**

**Syndesmotomes Roots Elevator**



**Periotome Roots Elevator**

**Syndesmotomes**



ROOT ELEVATORS

- Элеватор корневой экстракционный
- Elevator coronevii ekstraktsionnyy
- Elévateurs à racines
- Elevadores para raíces
- Wurzelheber
- المصاعد الجذر

**Function of Root Elevators:**

To loosen tooth or root from bony socket prior to placement of the extraction forceps.

HOWARD Slightly heavier design than Heidbrink picks.

HEIDBRINK



**Article# WI5-362**  
Heidbrink Root Apex Elevator (Left)



**Article# WI5-363**  
Heidbrink Root Apex Elevator (Right)



**Article# WI5-364**  
2 Howard



**Article# WI5-366**  
3 Howard



**Article# WI5-367**  
2 Heidbrink



**Article# WI5-369**  
3 Heidbrink



**Article# WI5-361**  
Heidbrink Root Apex Elevator

**FUNCTION:** To loosen small root fragments from bony socket

**Article# WI5-365**  
1 Howard

**Article# WI5-368**  
1 Heidbrink

Heidbrink Roots Elevator

Warwick-James



**Article# WI5-370/1**  
Heidbrink Fig.1

**Article# WI5-370/2**  
Heidbrink Fig.2

**Article# WI5-370/3**  
Heidbrink Fig.3



**Article# WI5-372**  
Fig. 2

**Article# WI5-371**  
Fig. 1

**Article# WI5-373**  
Fig. 3



**Article# WI5-375**  
Fig. 2 Chompret



**Article# WI5-376**  
Fig. 3 Chompret



**Article# WI5-377**  
Fig. 4 Chompret



**Article# WI5-374**  
Fig. 1 Chompret



Chompret syndesmotome, sickle pattern

ROOTELEVATOR SECTION 5

- Элеватор корневой экстракционный
- Элеватор корневий екстракційний
- Elévateurs à racines
- Elevadores para raices
- Wurzelheber
- المصاعد الجذر

**Function of Root Elevators:**

*To loosen tooth or root from bony socket prior to placement of the extraction forceps.*



**Article#**  
WI5-378  
Heidbrink  
Left



**Article#**  
WI5-379  
Heidbrink  
Right



**Article#** WI5-380  
Heidbrink  
Straight



**Article#**  
WI5-381  
Warwick-  
James  
Straight



**Article#**  
WI5-382  
Warwick-  
James  
Left



**Article#**  
WI5-383  
Warwick-  
James  
Right

**FUNCTION:** To Loosen Tooth or Root From Bony Socket Prior to Placement of The Extraction Forceps.



Coupland



**Article#**  
WI5-384  
Fig. 1  
190/15



**Article#**  
WI5-385  
Fig. 2  
190/16



**Article#**  
WI5-386  
Fig. 3  
190/17



*universal mini-elevator for fragments*



**Article#**  
WI5-387  
192/1



**Article#**  
WI5-388  
192/2



**Article#**  
WI5-389  
192/3



**Article#**  
WI5-390  
Fig. 1



Periotomes

**Article#**  
WI5-391  
Fig. 2



**Article#**  
WI5-392  
Fig. 3

ROOT ELEVATORS

- Элеватор корневой экстракционный
- Elévateurs à racines
- Wurzelheber
- Слеватор корневий екстракційний
- Elevadores para raices
- المصاعد الجذر

**Function of Root Elevators:**

*To loosen tooth or root from bony socket prior to placement of the extraction forceps.*

**PDL ELEVATORS**



ROOT ELEVATORS

ROOTELEVATOR SECTION 5

- Элеватор корневой экстракционный
- Слеватор корневий екстракційний
- Elévateurs à racines
- Elevadores para raíces
- Wurzelheber
- المصاعد الجذر

**Function of Root Elevators:**

To loosen tooth or root from bony socket prior to placement of the extraction forceps.

ROOT ELEVATORS



**Article# WI5-413/1**  
Root Elevator Set of 7 Pcs

**Article# WI5-407**  
Bein DL 32  
for upper roots round point.

**Article# WI5-408**  
Bein DL 33  
for upper roots round point.

**Article# WI5-409**  
Bein DL 34  
for upper roots round point.

**Article# WI5-410**  
Flohr Fig. 3  
for lower roots

**Article# WI5-411**  
Flohr Fig. 4  
for lower roots

**Article# WI5-412**  
Cryer-White  
for lower roots, wide pattern

**Article# WI5-413**  
Cryer-White  
for lower roots, wide pattern



**Article# WI5-414**  
Bein DL 32  
for upper roots round point.

**Article# WI5-415**  
Bein DL 33  
for upper roots round point.

**Article# WI5-416**  
Bein DL 34  
for upper roots round point.

**Article# WI5-417**  
Flohr Fig. 3  
for lower roots

**Article# WI5-418**  
Flohr Fig. 4  
for lower roots

**Article# WI5-419**  
Cryer-White  
for lower roots, wide pattern

**Article# WI5-420**  
Cryer-White  
for lower roots, wide pattern

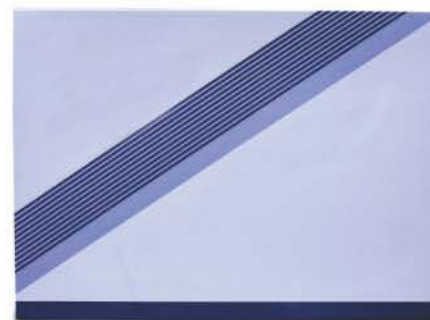

**Article# WI5-420/1**  
Root Elevator Set of 7 Pcs

ROOTELEVATOR SECTION 5

- Элеватор корневой экстракционный
- Слеватор корневий екстракційний
- Elévateurs à racines
- Elevadores para raíces
- Wurzelheber
- المصاعد الجذر

**Function of Root Elevators:**

To loosen tooth or root from bony socket prior to placement of the extraction forceps.

ROOT ELEVATORS



- |   |   |  |  |  |   |   |  |  |  |
|---|---|--|--|--|---|---|--|--|--|
| <b>Article#</b><br>WI5-421<br>Root Elevator<br>DL 32<br>for upper roots<br>round point. | <b>Article#</b><br>WI5-422<br>Root Elevator<br>DL 33<br>for upper roots<br>round point. | <b>Article#</b><br>WI5-423<br>Bein<br>DL 34<br>for upper roots<br>round point. | <b>Article#</b><br>WI5-424<br>Flohr<br>Fig. 3<br>for lower roots | <b>Article#</b><br>WI5-425<br>Flohr<br>Fig. 4<br>for lower roots | <b>Article#</b><br>WI5-426<br>Cryer-White<br>for lower roots,<br>wide pattern | <b>Article#</b><br>WI5-427<br>Cryer-White<br>for lower roots,<br>wide pattern | <b>Article#</b><br>WI5-428<br>Apical 301 | <b>Article#</b><br>WI5-429<br>Apical 302 | <b>Article#</b><br>WI5-430<br>Apical 303 |
|---|---|--|--|--|---|---|--|--|--|



Cryer root or fragment elevator

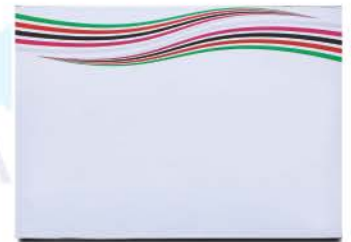

**Article# WI5-430/1**  
Root Elevator Set of 7 Pcs



- |  |  |  |  |   |  |   |
|--|--|--|--|---|--|---|
| <b>Article#</b><br>WI5-431<br>Bein<br>DL 32<br>for upper roots<br>round point. | <b>Article#</b><br>WI5-432<br>Bein<br>DL 33<br>for upper roots<br>round point. | <b>Article#</b><br>WI5-433<br>Bein<br>DL 34<br>for upper roots<br>round point. | <b>Article#</b><br>WI5-434<br>Cryer 27<br>(Left) | <b>Article#</b><br>WI5-435<br>Cryer 28<br>(Right) | <b>Article#</b><br>WI5-436<br>Flohr<br>3mm<br>(Left) | <b>Article#</b><br>WI5-437<br>Flohr<br>3mm<br>(Right) |
|--|--|--|--|---|--|---|



**Article# WI5-437/1**  
Root Elevator Set of 7 Pcs

## Extraction Forceps Function

Dental forceps are pliers-like instruments that are used to grasp teeth.

A dentist will usually have a number of different ones on hand, each having a design that's tailored to:

The specific shape of the tooth it's intended to remove (such as incisors vs. molars having two roots vs. molars having three roots).

The location of the tooth in the mouth (such as front vs. back, or left lower molar vs. right upper molar.) How they're used.

A dentist will grasp a tooth with their forceps and then firmly and deliberately rock it back and forth as much as it will.

Because the bone that surrounds the tooth is compressible, the socket will gradually start to expand.

As it does, the range of the dentist's side-to-side motions will increase.

In addition to this rocking motion, the dentist will also rotate the tooth back and forth.

This twisting action helps to rip and tear the tooth away from the ligament that binds it in place.

At some point, the socket will be enlarged enough, and the ligament torn away enough, that the tooth can be easily removed.

## Handle Selection For Extracting Forceps

Dear Valued Buyers these are our Handle Styles



English Pattern



English Pattern



English Pattern, Anatomical Handle



American Pattern



Deep Grip Forceps With Hole Pattern



Hole Pattern



Dear Valued Buyers if any Universal Fig. No. of Extracting Forceps not Found in our Catalogue you Can Refer the Fig. No. From These Diagram.  
Dear Valued Buyers these are or Handle Styles

**HERE IS THE UNIVERSAL FIG. NUMBERS IN BOX**

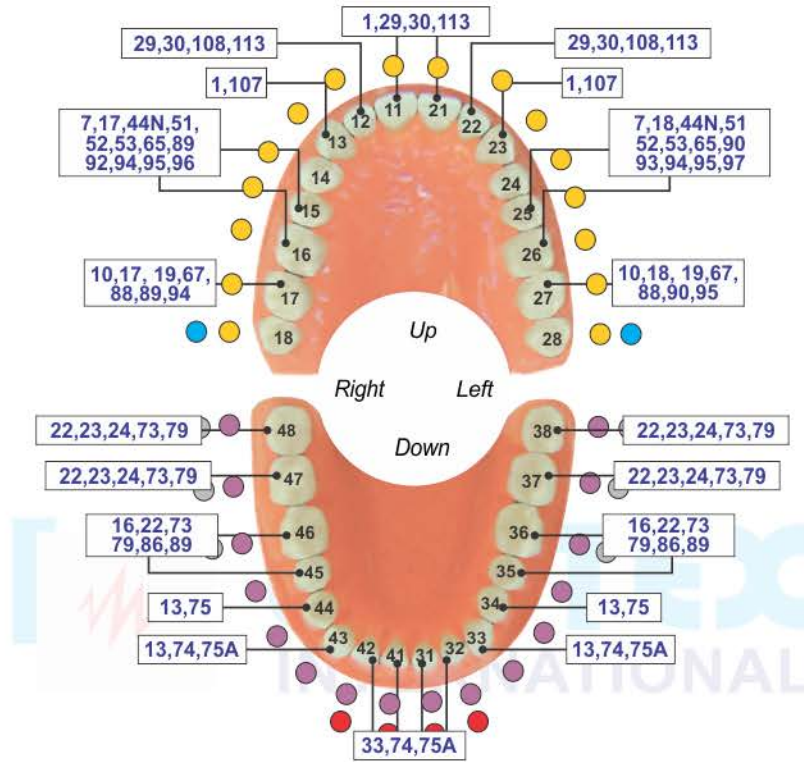

**HERE IS THE UNIVERSAL FIG. NUMBERS IN BOX**

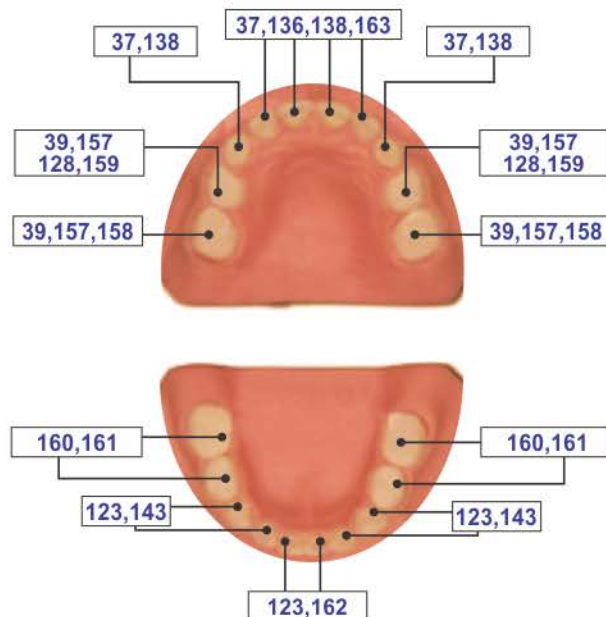

- Инструменты для реставрации
- Instruments pour plombage
- Füllungsinstrumente (mit Kontrawinkel)
- Инструменти для реставрації
- Instrumentos para obturaciones
- ملء الصكوك



**Article# WI6-001**  
Fig. 1  
Upper Centrals  
and Canines



**Article# WI6-002**  
Fig. 2  
Upper Laterals  
and Canines



**Article# WI6-003**  
Fig. 4  
Lower Incisors  
and Canines

*Straight extracting forceps for upper incisors and canines*



*Straight extracting forceps for upper incisors and canines*



*Straight extracting forceps for upper incisors and canines*



**Article# WI6-004**  
Fig. 7  
Upper Premolars



**Article# WI6-005**  
Fig. 8  
Lower Premolars

- Инструменты для реставрации
- Instruments pour plombage
- Füllungsinstrumente (mit Kontrawinkel)
- Инструменти для реставрації
- Instrumentos para obturaciones
- ملء الصكوك

EXTRACTING FORCEPS



**Article# W16-006**  
Fig. 13  
Lower Premolars



*Straight extracting forceps for upper incisors and canines*



**Article# W16-007**  
Fig. 17  
Upper Molars, Right



*Straight extracting forceps for upper incisors and canines*



**Article# W16-008**  
Fig. 18  
Upper Molars, Left



*Straight extracting forceps for upper incisors and canines*



**Article# W16-009**  
Fig # 18A  
upper molars



**Article# W16-010**  
Fig # 19  
upper third molars



**Article# W16-011**  
Fig # 20  
lower third molar

- Инструменты для реставрации
- Instruments pour plombage
- Füllungsinstrumente (mit Kontrawinkel)
- Инструменти для реставрації
- Instrumentos para obturaciones
- ملء الصكوك



Article# W16-012  
Fig. 21  
Lower Molar



Article# W16-013  
Fig # 22  
Lower Molar



Angled extracting forceps for upper roots



Article# W16-014  
Fig # 24  
lower molar, right



Article# W16-015  
Fig # 29  
upper roots



Article# W16-016  
Fig # 30  
Upper Roots

- Инструменты для реставрации
- Instruments pour plombage
- Füllungsinstrumente (mit Kontrawinkel)
- Инструменти для реставрації
- Instrumentos para obturaciones
- ملء الصكوك

WISDOM EXTRACTING FORCEPS



**Article# WI6-017**  
**Routurier**  
 (# 22 1/2 L)  
 lower molars and  
 wisdoms, left

**Article# WI6-018**  
**Routurier**  
 (# 22 1/2 R)  
 lower molars and  
 wisdoms, right

**Article# WI6-019**  
**Routurier**  
 (# 33 1/2 L)  
 lower molar and  
 wisdom roots, left

**Article# WI6-020**  
**Routurier**  
 (# 33 1/2 R)  
 lower molar and  
 wisdom roots, right

**Article# WI6-021**  
**Fig. 186L**  
 lower molars

**Article# WI6-022**  
**Fig. 186R**  
 lower molars

EXTRACTING FORCEPS

■ Инструменты для реставрации ■ Инструменти для реставрації  
■ Instruments pour plombage ■ Instrumentos para obturaciones  
■ Füllungsinstrumente (mit Kontrawinkel) ■ ملء الصكوك



**Article# W16-023**  
Fig # 31  
Lower Roots Both Sides EF, Serrated, EU

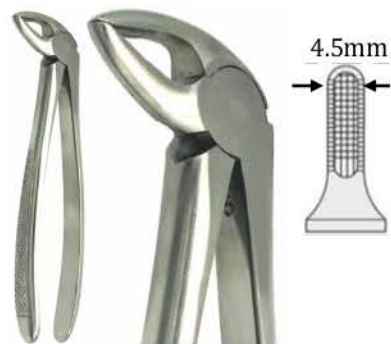

**Article# W16-024**  
Fig # 32  
Lower Roots Both Side EF, Serrated, EU



**Article# W16-025**  
# 33  
lower roots



**Article# W16-026**  
# 33A  
Lower Roots



**Article# W16-027**  
# 33M  
Lower roots  
with long beak



Thin Tip

**Article# W16-028**  
**Fig # 34**  
Upper incisors and premolars deep-gripping



Wide Tip

**Article# W16-029**  
**Fig # 34A**  
Upper centrals / cains deep-gripping



Thin Tip

**Article# W16-030**  
**Fig # 35**  
upper premolars deep-gripping



Wide Tip

**Article# W16-031**  
**Fig # 35A**  
Upper incisors and premolars deep-gripping



Thin Tip

**Article# W16-032**  
**Fig # 36**  
Lower premolars deep-gripping



Wide Tip

**Article# W16-033**  
**Fig # 36A**  
Lower premolars deep-gripping



**Article# W16-034**  
**Fig # F-7C**  
lower molar



**Article# W16-035**  
**Fig # 336**  
lower premolars deep-gripping

■ Инструменты для реставрации  
■ Instruments pour plombage  
■ Füllungsinstrumente (mit Kontrawinkel)

■ Инструменти для реставрації  
■ Instrumentos para obturaciones  
■ ملء الصكوك



**Article# W16-036**  
**Fig # 41**  
Upper Roots Both  
Sides EF, Serrated, EU



**Article# W16-037**  
**Fig # 44Z**



**Article# W16-038**  
**Fig # 46L**  
Lower Roots EF, Serrated EU



**Article# W16-039**  
**Fig # 46XL**  
Apex Forceps Lower Root  
Deep Root Pick



**Article# W16-040**  
**Fig # 49**  
Upper Roots EF, Serrated, EU



**Article# W16-041**  
**Fig # 51**  
Upper Roots



**Article# W16-042**  
**Fig # 51A**  
Upper Roots



**Article# W16-043**  
**Fig # 51AL**



**Article# W16-044**  
**Fig # 331**  
upper roots  
deep-gripping

■ Инструменты для реставрации  
■ Instruments pour plombage  
■ Füllungsinstrumente (mit Kontrawinkel)

■ Инструменти для реставрації  
■ Instrumentos para obturaciones  
■ ملء الصكوك

EXTRACTING FORCEPS



**Article# W16-045**  
**Fig # 67**  
Upper Third Molars



**Article# W16-046**  
**Fig # 67A**  
Upper Third Molars



**Article# W16-047**  
**Fig # 67N**  
Lower third molars  
deep-gripping



**Article# W16-048**  
**Fig # 68**  
Lower roots

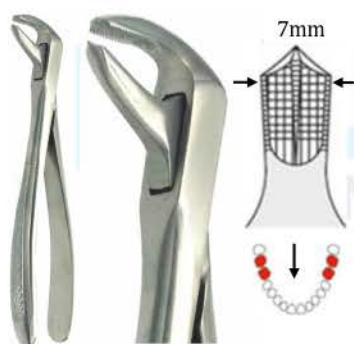

**Article# W16-049**  
**Fig # 73**  
Lower Molars EF, Serrated, EU



**Article# W16-050**  
**Fig # 73 A**  
lower molars



**Article# W16-051**  
**Fig # 73 S**



**Article# W16-052**  
**Fig # 74**  
Lower Roots EF, Serrated, EU

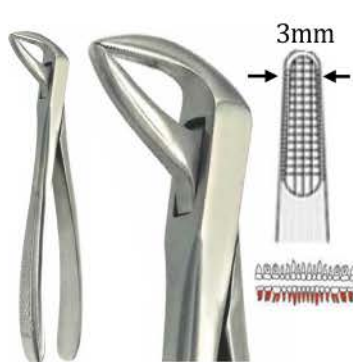

**Article# W16-053**  
**Fig # 74N**  
Lower Roots EF, Serrated, EU



**Article# W16-054**  
**Fig # 75**  
Lower Premolars



**Article# W16-055**  
**Fig # 79**  
Lower Third Molars

■ Инструменты для реставрации  
■ Instruments pour plombage  
■ Füllungsinstrumente (mit Kontrawinkel)

■ Інструменти для реставрації  
■ Instrumentos para obturaciones  
■ ملء الصكوك



Article# W16-056  
Fig # 86A  
Lower Molars



Article# W16-057  
Fig # 86B  
lower molars



Article# W16-058  
Fig # 86C  
lower molars



Article# W16-059  
Fig # 87  
Lower Molars



Article# W16-060  
Fig # 89  
Upper Molars,  
Right



Article# W16-061  
Fig # 90  
Upper Molars Left EF, Serrated, EU



Article# W16-062  
Fig # 114  
Lower roots  
and centrals



Article# W16-063  
Fig # 143  
Lower roots  
and centrals



Article# W16-064  
Fig # 144 (Balding)  
Lower roots  
and centrals

■ Инструменты для реставрации  
■ Instruments pour plombage  
■ Füllungsinstrumente (mit Kontrawinkel)
 ■ Инструменти для реставрації  
■ Instrumentos para obturaciones  
■ ملء الصكوك



**Article# W16-065**  
 FIG. 97  
 Radici superiori molto sottili  
 Very thin upper roots  
 Racines supérieurs très fines  
 Raíces superiores muy delgada



**Article# W16-066**  
 FIG. 151  
 Radici superiori  
 Upper roots  
 Racines supérieurs  
 Raíces superiores



**Article# W16-67**  
 FIG. 351S  
 Radici superiori molto sottili  
 Very thin upper roots  
 Racines supérieurs très fines  
 Raíces superiores muy delgadas

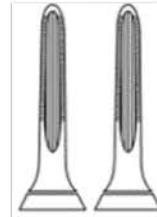

**Article# W16-071**  
 fig# 233  
 Lower Roots  
 EF, Serrated, EU



**Article# W16-068**  
 fig # 97  
 Upper Roots EF,  
 Serrated, EU



**Article# W16-069**  
 Fig. 130  
 (Ladmore, 190mm)  
 Upper wisdoms



**Article# W16-070**  
 FIG. 333S  
 Radici inferiori molto sottili  
 Very thin lower roots  
 Racines inférieurs très fines



**Article# W16-072**  
 # 146  
 Apex Forceps Lower Root  
 Deep Root Pick



**Article# W16-073**  
 # 153  
 Apex Forceps Upper Root  
 Deep Root Pick



**Article# W16-074**  
 # 149  
 Apex Forceps Upper Root  
 Deep Root Pick

- Инструменты для реставрации
- Instruments pour plombage
- Füllungsinstrumente (mit Kontrawinkel)
- Инструменти для реставрації
- Instrumentos para obturaciones
- ملء الصكوك



**Article# W16-076**

FIG. MEAD

Incisivi, canini, premolari e radici superiori  
Upper incisors, canines, premolars and roots  
Incisives, canines, prémolaires et racines supérieures  
Incisivos, caninos, premolares y raíces superiores



**Article# W16-077**

FIG. MEAD

1° - 2° - 3° molare - universale  
1<sup>st</sup> - 2<sup>nd</sup> - 3<sup>rd</sup> molar - universal  
1° - 2° - 3° molaire - universal  
1° - 2° - 3° molare - universale



**Article# W16-078**

FIG. MEAD

Incisivi e radici inferiori  
Lower incisors and roots  
Incisives et racines inférieures  
Incisivos y raíces inferiores

**Article# W16-079**

FIG. MEAD

1° - 2° - 3° molare inferiori  
Lower 1<sup>st</sup> - 2<sup>nd</sup> - 3<sup>rd</sup> molar  
1° - 2° - 3° molaire inférieurs



**Article# W16-075**

Lower Molar  
Fig. 23 Cow Horn

EXTRACTING FORCEPS



**Article# W16-080**  
Meissner  
Extracting Forceps

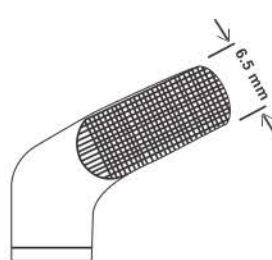
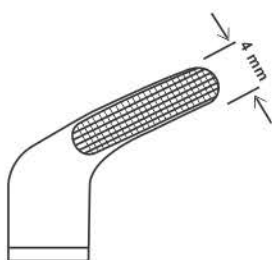
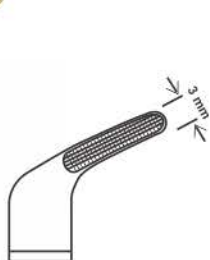

**Article# W16-081**  
Meissner  
Extracting Forceps



**Article# W16-082**  
Meissner  
Extracting Forceps



**Article# W16-083**  
Comellas Forceps  
Anatomical Handle

■ Инструменты для реставрации  
■ Instruments pour plombage  
■ Füllungsinstrumente (mit Kontrawinkel)

■ Инструменти для реставрації  
■ Instrumentos para obturaciones  
■ ملء الصكوك

(Deep Gripe Extracting Forceps)

A-TRAUMATIC EXTRACTION FORCEPS

Improved tapered beaks for complete root contact.  
 Cross serrations for a never slip grasp.  
 Easily enter the sub gingival.

- No Fracture
- No Tissue Damage
- Extraction With Easy



Wide Tip



Thin Tip



Wide Tip



Thin Tip

Article# W16-085  
Fig. 34A  
Upper Anterior

Article# W16-086  
Fig. 35  
Upper Universal

Article# W16-087  
Fig. 35A  
Upper Universal

Article# W16-088  
Fig. 321  
Lower Universal

Deep Root Pick Forceps



Article# W16-089  
Fig. 321A  
Lower Root Molars



Thin Tip



Article# W16-090  
Fig. 36  
Lower Premolars  
Deep-Gripping



Wide Tip



Article# W16-091  
Fig. 36A  
Lower Premolars  
Deep-Gripping

Article# W16-084  
Fig. 34  
Upper Anterior

EXTRACTING FORCEPS



Article# W16-093  
Fig. 35M



Article# W16-094  
Fig. 35N



Article# W16-095  
Fig. 79



Thin Tip



Article# W16-097  
Fig. 35  
Upper Universal



Wide Tip



Article# W16-098  
Fig. 35A  
Upper Universal



Article# W16-099  
Fig. 79  
Lower Third Molars



Article# W16-092  
67A

Straight extracting forceps for upper incisors and canines



Article# W16-096  
Fig. 67A  
Upper Third Molars



Straight extracting forceps for upper incisors and canines

- Инструменты для реставрации
- Instruments pour plombage
- Füllungsinstrumente (mit Kontrawinkel)
- Инструменти для реставрації
- Instrumentos para obturaciones
- ملء الصكوك

## DEEP ROOT PICK FORCEPS

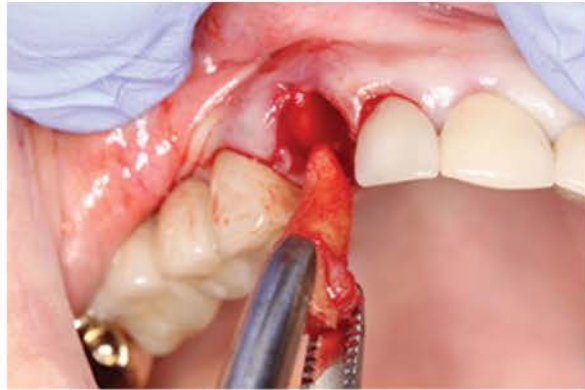

Straight extracting forceps for upper incisors and canines



Straight extracting forceps for upper incisors and canines



Article# W16-100

Fig. 79 T

Lower Third Molars



Straight extracting forceps for upper incisors and canines

EXTRACTING FORCEPS



Article# W16-102  
Fig. 45  
Apex Forceps  
Lower Root  
Deep Root Pick



Article# W16-103  
Fig. 51  
Apex Forceps  
Upper Root  
Deep Root Pick



Article# W16-104

Fig. 46XL

Apex Forceps Lower Root  
Deep Root Pick



Article# W16-105  
Upper Root  
Fig. 44



Article# W16-106  
Lower Root  
Fig. 45



Article# W16-107  
Upper Root  
Fig. 51



Article# W16-101

Fig. 44

Apex Forceps Upper Root  
Deep Root Pick



forceps for upper incisors, premolars and roots

**EXTRACTING FORCEPS  
SECTION 6**

■ Инструменты для реставрации  
■ Instruments pour plombage  
■ Füllungsinstrumente (mit Kontrawinkel)
 ■ Инструменти для реставрації  
■ Instrumentos para obturaciones  
■ ملء الصكوك



<b>Article#</b> <b>WI6-108</b> F-1 Upper Universal	<b>Article#</b> <b>WI6-109</b> F-2 Lower Universal	<b>Article#</b> <b>WI6-110</b> F-3 Upper Anterior	<b>Article#</b> <b>WI6-111</b> Lower Molar Modify	<b>Article#</b> <b>WI6-112</b> F-4N Lower Anterior	<b>Article#</b> <b>WI6-123</b> F-6 Upper 3rd Molar
---	---	--	--	---	---

**Article# WI6-115** Extracting Forceps Dual Grip Set of 6 Pcs



**Article# WI6-114**  
Extracting Forceps Dual Grip Set of 6 Pcs



<b>Article#</b> <b>WI6-116</b> Fig. 336 lower premolars deep-gripping	<b>Article#</b> <b>WI6-117</b> Fig. 1 Upper Anterior	<b>Article#</b> <b>WI6-118</b> Fig. 35 Upper Universal	<b>Article#</b> <b>WI6-119</b> Fig. 36 Lower Premolars Deep-Gripping	<b>Article#</b> <b>WI6-120</b> Fig. 67 Upper Thrid Molars	<b>Article#</b> <b>WI6-121</b> Fig. 79A Apex Forceps Lower Universal Deep Root Pick
---	---	--	--	---	---



**Article# WI6-122**  
Extracting Forceps Dual Grip Set of 6 Pcs

**(Deep Gripe Extracting Forceps)**



<b>Article#</b> <b>WI6-124</b> Fig. 321 Lower Universal	<b>Article#</b> <b>WI6-125</b> Fig. 36 Lower Premolars Deep-Gripping	<b>Article#</b> <b>WI6-126</b> Fig. 336 lower premolars deep-gripping	<b>Article#</b> <b>WI6-127</b> Fig. 67 Upper Thrid Molars	<b>Article#</b> <b>WI6-128</b> Fig. 79 T Lower Thrid Molars
---	---	--	---	--



**Article# WI6-123** Fig. 321A Lower Root Molars

- No Fracture
- No Tissue Damage
- Extraction With Easy

**Article# WI6-129**  
Deep Gripe Extracting Forceps



EXTRACTING FORCEPS

Инструменты для реставрации  
 Instruments pour plombage  
 Füllungsinstrumente (mit Kontrawinkel)

Инструменти для реставрації  
 Instrumentos para obturaciones  
 ملء الصكوك



Fig. 1  
 upper  
 laterals  
 and canines



Article# W16-130  
 Set of 10 Pieces

- Fig. 1
- Fig. 7
- Fig. 13
- Fig. 17
- Fig. 18
- Fig. 22
- Fig. 51A
- Fig. 67
- Fig. 74N
- Fig. 79

Fig. 7  
 upper premolars



Fig. 13  
 lower premolars



Fig. 17  
 upper molars, right



Fig. 18  
 upper molars, left



Fig. 22  
 lower roots



Fig. 51A  
 upper roots



Fig. 67  
 upper third molars



Fig. 74N  
 lower molar



Fig. 79  
 lower third molars



Extracting forceps for upper roots



■ Инструменты для реставрации  
■ Instruments pour plombage  
■ Füllungsinstrumente (mit Kontrawinkel)

■ Інструменти для реставрації  
■ Instrumentos para obturaciones  
■ ملء الصكوك



Fig. 1  
upper  
laterals  
and canines



Article# WI6-131  
Set Of 10 Pices

Fig. 7  
upper premolars



Fig. 13  
lower premolars



Fig. 17  
upper molars, right



Fig. 18  
upper molars, left



Fig. 22  
lower roots



Fig. 33A  
upper roots



Fig. 51A  
upper third molars



Fig. 67A  
upper third molars



Fig. 79  
lower third molars



■ Инструменты для реставрации  
■ Instruments pour plombage  
■ Füllungsinstrumente (mit Kontrawinkel)

■ Инструменти для реставрації  
■ Instrumentos para obturaciones  
■ ملء الصكوك

**Pediatric Tooth Extracting Forceps**



**Article# WI6-132**  
English Pattern  
Klein Fig. 4  
Pedodontic Upper root



**Article# WI6-133**  
English Pattern  
Klein Fig. 1  
Pedodontic, Upper Incisors



**Article# WI6-134**  
English Pattern Klein Fig. 5  
Pedodontic Lower Incisors.



**Article# WI6-135**  
English Pattern  
Klein Fig. 2  
Pedodontic Upper Premolars

**Baby Tooth Extraction Forceps**



**Article# WI6-136**  
Set of 7 Pieces



**Article# WI6-137**  
English Pattern  
Klein Fig. 6  
Pedodontic Lower Molars



**Article# WI6-138**  
English Pattern  
Klein Fig. 3  
Pedodontic Upper Molars Universal

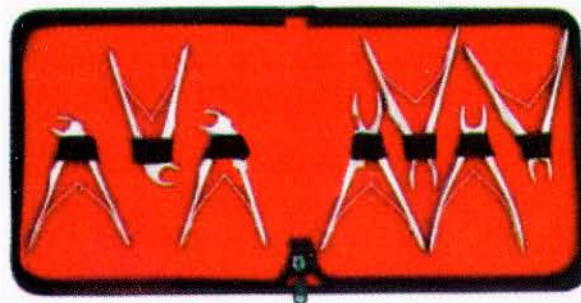

**Article# WI6-139**  
Tooth Forceps Children Set For 7Pcs



**Article# WI6-140**  
English Pattern  
Klein Fig. 7  
Pedodontic Lower Molars,

- |                  |        |
|------------------|--------|
| 01 Tooth Forceps | Fig. 1 |
| 02 Tooth Forceps | 2      |
| 03 Tooth Forceps | 3      |
| 04 Tooth Forceps | 4      |
| 05 Tooth Forceps | 5      |
| 06 Tooth Forceps | 6      |
| 07 Tooth Forceps | 7      |

■ Инструменты для реставрации ■ Инструменти для реставрації  
■ Instruments pour plombage ■ Instrumentos para obturaciones  
■ Füllungsinstrumente (mit Kontrawinkel) ■ ملء الصكوك

استخراج الملقط



**Article# WI6-141**  
Witzel Forceps With Gold  
Set of 3 Pcs



**Article# WI6-145**  
Witzel Forceps With Hole And Screw Pattern  
Set of 3 Pcs



**Article# WI6-142**  
#401(301)  
160mm  
Lower roots, Universal



**Article# WI6-146**  
#401(301)  
160mm  
Lower roots, Universal



**Article# WI6-143**  
#400(300)  
165mm  
Upper roots, Universal



**Article# WI6-147**  
#400(300)  
165mm  
Upper roots, Universal



Witzel  
**Article# WI6-144**  
165mm  
Lower roots, Universal



Witze.  
**Article# WI6-148**  
165mm  
Lower roots, Universal



**Article# WI6-149**  
Fig # 223  
(Witzel, 150mm)  
Universal for lower roots



**Article# WI6-150**  
Fig # 221  
(Witzel, 150mm)  
Universal for upper roots



**Article# WI6-151**  
Splinter Forceps  
15.5cm



**Article# WI6-152**  
Splinter Forceps  
15.5cm 45°



**Article# WI6-153**  
Stieglitz  
Root Fragments



**Article# WI6-155**  
Stieglitz Splinter  
Forceps  
140mm 90°



**Article# WI6-156**  
Stieglitz Splinter Forceps  
140mm Straight

■ Инструменты для реставрации  
■ Instruments pour plombage  
■ Füllungsinstrumente (mit Kontrawinkel)

■ Инструменти для реставрації  
■ Instrumentos para obturaciones  
■ ملء الصكوك



**Article# WI6-157**  
 Extracting Forceps  
 Set of 10 Pieces  
 Extracting Forceps Fig. 2  
 Extracting Forceps Fig. 7  
 Extracting Forceps Fig. 13  
 Extracting Forceps Fig. 17  
 Extracting Forceps Fig. 18  
 Extracting Forceps Fig. 22  
 Extracting Forceps Fig. 33  
 Extracting Forceps Fig. 51A  
 Extracting Forceps Fig. 67A  
 Extracting Forceps Fig. 79



**Article# WI6-158**  
 Extracting Forceps  
 Set of 10 Pieces  
 Extracting Forceps Fig. 2  
 Extracting Forceps Fig. 7  
 Extracting Forceps Fig. 13  
 Extracting Forceps Fig. 17  
 Extracting Forceps Fig. 18  
 Extracting Forceps Fig. 22  
 Extracting Forceps Fig. 33  
 Extracting Forceps Fig. 51A  
 Extracting Forceps Fig. 67A  
 Extracting Forceps Fig. 79



**Article# WI6-159**  
 Extracting Forceps (English Pattern)  
 Set of 13 Pieces  
 Extracting Forceps Fig. 2  
 Extracting Forceps Fig. 7  
 Extracting Forceps Fig. 13  
 Extracting Forceps Fig. 17  
 Extracting Forceps Fig. 18  
 Extracting Forceps Fig. 22  
 Extracting Forceps Fig. 33  
 Extracting Forceps Fig. 51A  
 Extracting Forceps Fig. 67A  
 Extracting Forceps Fig. 79  
 Extracting Forceps Fig. 86C  
 Extracting Forceps Fig. 89  
 Extracting Forceps Fig. 90



**Article# WI6-160**  
 Extracting Forceps (English Pattern)  
 Set of 10 Pieces  
 Extracting Forceps Fig. 13S  
 Extracting Forceps Fig. 22S  
 Extracting Forceps Fig. 30S  
 Extracting Forceps Fig. 33S  
 Extracting Forceps Fig. 37  
 Extracting Forceps Fig. 38  
 Extracting Forceps Fig. 39  
 Extracting Forceps Fig. 39L  
 Extracting Forceps Fig. 39R  
 Extracting Forceps Fig. 51S

Инструменты для реставрации

Instruments pour plombage

Füllungsinstrumente (mit Kontrawinkel)

Инструменти для реставрації

Instrumentos para obturaciones

ملء الصكوك



**Article# WI6-161**

Extracting Forceps (English Pattern)

Set of 10 Pieces

- Extracting Forceps Fig. 1
- Extracting Forceps Fig. 7
- Extracting Forceps Fig. 13
- Extracting Forceps Fig. 17
- Extracting Forceps Fig. 18
- Extracting Forceps Fig. 22
- Extracting Forceps Fig. 33A
- Extracting Forceps Fig. 51A
- Extracting Forceps Fig. 67A
- Extracting Forceps Fig. 79



**Article# WI6-162**

Extracting Forceps (Anatomical Handle)

Set of 10 Pieces

- Extracting Forceps Fig. 1
- Extracting Forceps Fig. 7
- Extracting Forceps Fig. 13
- Extracting Forceps Fig. 17
- Extracting Forceps Fig. 18
- Extracting Forceps Fig. 22
- Extracting Forceps Fig. 33A
- Extracting Forceps Fig. 51A
- Extracting Forceps Fig. 67A
- Extracting Forceps Fig. 79



**Article# WI6-163**

Extracting Forceps (Hole Pattern Handle)

Set of 10 Pieces

- Extracting Forceps Fig. 1
- Extracting Forceps Fig. 7
- Extracting Forceps Fig. 13
- Extracting Forceps Fig. 17
- Extracting Forceps Fig. 18
- Extracting Forceps Fig. 22
- Extracting Forceps Fig. 33A
- Extracting Forceps Fig. 51A
- Extracting Forceps Fig. 67A
- Extracting Forceps Fig. 79





**Article# W16-170**  
Luxating Elevator  
Straight 3mm



**Article# W16-171**  
Luxating Elevator  
Curved 3mm



**Article# W16-183**  
Goldman Fox  
Scissor Cvd



**Article# W16-184**  
Crile Wood  
Needle Holder TC



**Article# W16-185**  
Atraumatic Extraction Kit  
of 16 Pcs

**Atraumatic Extraction Kit**

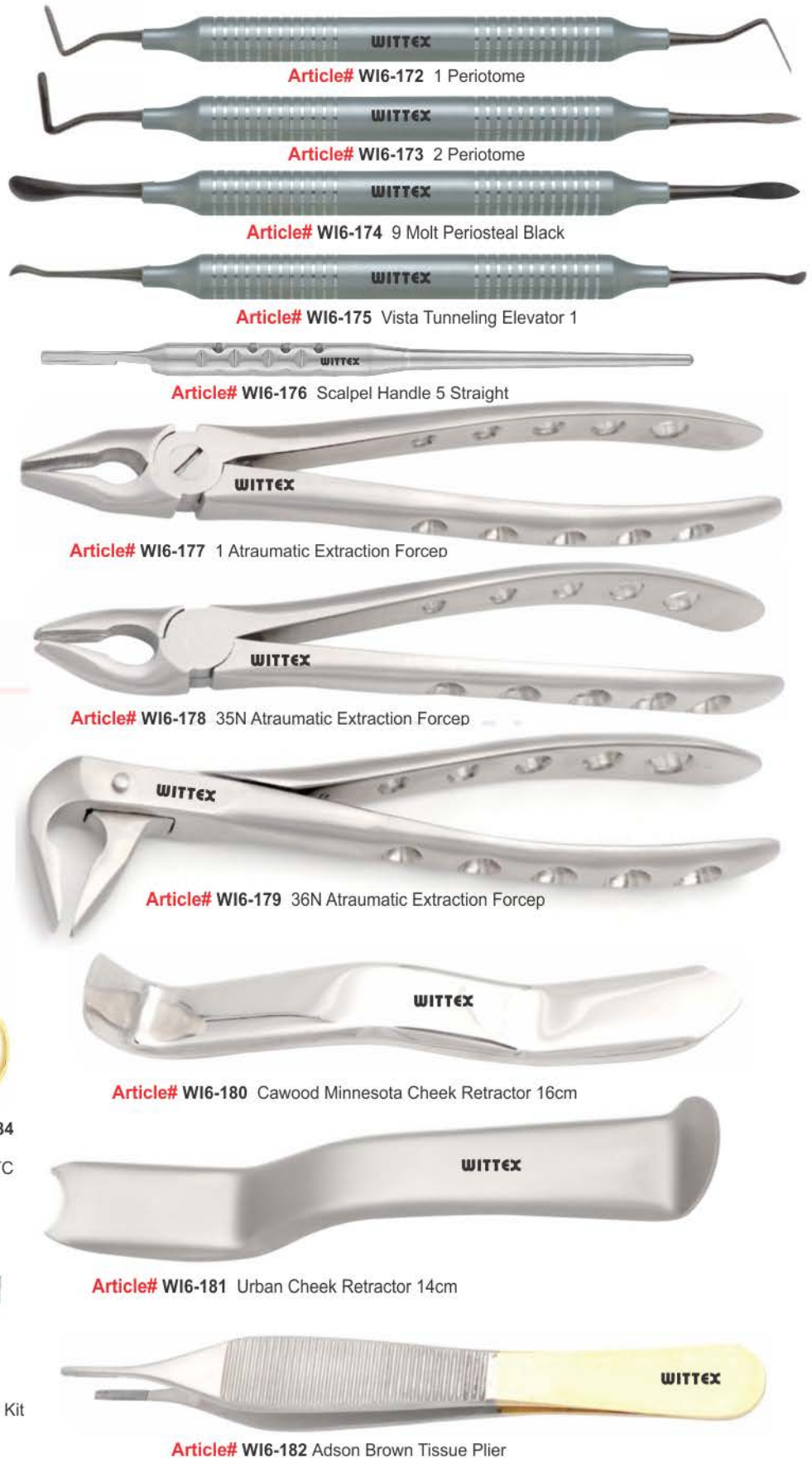

**Article# W16-172** 1 Periostome

**Article# W16-173** 2 Periostome

**Article# W16-174** 9 Molt Periosteal Black

**Article# W16-175** Vista Tunneling Elevator 1

**Article# W16-176** Scalpel Handle 5 Straight

**Article# W16-177** 1 Atraumatic Extraction Forcep

**Article# W16-178** 35N Atraumatic Extraction Forcep

**Article# W16-179** 36N Atraumatic Extraction Forcep

**Article# W16-180** Cawood Minnesota Cheek Retractor 16cm

**Article# W16-181** Urban Cheek Retractor 14cm

**Article# W16-182** Adson Brown Tissue Plier

Щипцы экстракционные (американская форма)  
 Daviers - forme americane  
 Fórceps de extracción - forma americana

Щипці екстракційні (американська форма)  
 Pinzere per estrazione - forma americana  
 استخراج الملقط (النمط الأمريكي)



**Article# WI6-186**  
**# 1STD**  
 Winter  
 upper centrals and canines

**Article# WI6-187**  
 Fig. 1  
 upper incisors  
 and roots

**Article# WI6-188**  
 Cryer  
 Fig. 150

Щипцы экстракционные (американская форма)  
 Daviers - forme americane  
 Fórceps de extracción - forma americana

Щипці екстракційні (американська форма)  
 Pinzere per estrazione - forma americana  
 استخراج الملقط (النمط الأمريكي)



Straight extracting forceps for upper incisors and canines



**Article# WI6-190**  
 Fig. 62  
 incisors, premolars,  
 deciduous teeth

**Article# WI6-191**  
 # 10S  
 upper roots

**Article# WI6-192**  
 # 17  
 lower molars



**Article# WI6-189**  
 Fig. 150A  
 Cryer  
 upper incisors,  
 premolars, roots



**Article# WI6-193**  
 Harris  
 Fig. 18R

**Article# WI6-194**  
 Harris  
 Fig. 18L



Straight extracting forceps for upper incisors and canines



Straight extracting forceps for upper incisors and canines

- Щипцы экстракционные (американская форма)
- Daviers - forme americane
- Fórceps de extracción - forma americana

- Щипці екстракційні (американська форма)
- Pinzere per estrazione - forma americana
- ستخراج الملقط (النمط الأمريكي)



**Article#**  
**WI6-195**  
Fig. 210  
upper third molars



**Article#**  
**WI6-196**  
Fig. 53R  
upper molars, right



**Article#**  
**WI6-197**  
Fig. 53L  
upper molars, left



**Article#**  
**WI6-198**  
NEVIUS  
Fig. 88R



Straight extracting forceps for upper incisors and canines



Straight extracting forceps for upper incisors and canines



Straight extracting forceps for upper incisors and canines

Щипцы экстракционные (американская форма)  
Daviers - forme américaine  
Fórceps de extracción - forma americana

Щипці екстракційні (американська форма)  
Pinzere per estrazione - forma americana  
ستخراج الملقط (النمط الأمريكي)



**Article# W16-199**  
Fig. 24  
upper molars



**Article# W16-200**  
# 210S  
upper third molars



**Article# W16-201**  
# 210H  
upper third molars



**Article# W16-202**  
# 286  
Upper Roots,  
Premolars, Incisors

**WITTEX**  
INTERNATIONAL



**Article# W16-203**  
# 99C  
Kells  
upper incisors,  
canines, premolars



**Article# W16-204**  
# 222  
lower third molars



**Article# W16-205**  
# 286  
Lower Molar

Щипцы экстракционные (американская форма)  
 Daviers - forme américaine  
 Fórceps de extracción - forma americana

Щипці екстракційні (американська форма)  
 Pinzere per estrazione - forma americana  
 استخراج الملقط (النمط الأمريكي)



**Article# WI6-206**  
 Nevius  
 Fig. 88L  
 upper molars, left



**Article# WI6-207**  
 Fig. 65  
 upper incisors  
 and roots



**Article# WI6-208**  
 Partly Fig. 32A  
 upper premolars  
 and roots



**Article# WI6-209**  
 Partly Fig. 32  
 upper premolars  
 and molars

Щипцы экстракционные (американская форма)  
Daviers - forme américaine  
Fórceps de extracción - forma americana

Щипці екстракційні (американська форма)  
Pinzere per estrazione - forma americana  
ستخراج الملقط (النمط الأمريكي)



**Article# W16-210**  
COHEN  
universal

**Article# W16-211**  
Fig. 203  
lower incisors  
and roots

**Article# W16-212**  
Tomes Fig. 69  
upper and lower  
roots

Щипцы экстракционные (американская форма)  
Daviers - forme americane  
Fórceps de extracción - forma americana

Щипці екстракційні (американська форма)  
Pinzere per estrazione - forma americana  
ستخراج الملقط (النمط الأمريكي)



**Article# WI6-213**  
Fig. 23  
lower molars



**Article# WI6-214**  
Fig. 16  
lower molars



**Article# WI6-215**  
Physic Fig. 5  
lower third molars



**Article# WI6-216**  
Harris Fig. 15  
lower molars



**Article# WI6-217**  
Fig. 103

Щипцы экстракционные (американская форма)  
 Daviers - forme américaine  
 Fórceps de extracción - forma americana

Щипці екстракційні (американська форма)  
 Pinzere per estrazione - forma americana  
 استخراج الملقط (النمط الأمريكي)



**Article# W16-218**  
 Hull  
 Fig. 101  
 Deciduous teeth

**Article# W16-219**  
 Cryer  
 Fig. 150S  
 upper teeth,  
 for children

**Article# W16-220**  
 Fig. 150 AS

- Щипцы экстракционные (американская форма)
- Daviers - forme américaine
- Fórceps de extracción - forma americana

- Щипці екстракційні (американська форма)
- Pinzere per estrazione - forma americana
- ستخراج الملقط (النمط الأمريكي)



**Article# WI6-221**  
Cryer  
Fig. 151  
lower teeth,  
for children

**Article# WI6-222**  
Fig. 151 S  
lower incisors,  
premolars, roots

**Article# WI6-223**  
Fig. 151 AS

Щипцы экстракционные (американская форма)  
Daviers - forme americane  
Fórceps de extracción - forma americana

Щипці екстракційні (американська форма)  
Pinzere per estrazione - forma americana  
ستخراج الملقط (النمط الأمريكي)



**Article# W16-224**  
**# 16S**  
lower molars for children



**Article# W16-225**  
**# 17S**  
lower molars



**Article# W16-226**  
**# 23 S**  
Lower molars



**Article# W16-227**  
**# 27**  
lower molars



**Article# W16-228**  
**# 18LS**  
upper molars left



**Article# W16-229**  
**# 18RS**  
upper molars right



**Article# W16-230**  
**# 85 Tomas**  
lower canines, premolars and molars



**Article# W16-231**  
**# 85A Tomas**  
lower canines, premolars and molars



**Article# W16-232**  
**# 69S**  
upper and lower roots



**Article# W16-233**  
**# 99A Kells**  
upper incisors, canines, premolars



**Article# W16-234**  
**# 217**  
lower molars

Щипцы экстракционные (американская форма)  
 Daviers - forme americane  
 Férceps de extracción - forma americana

Щипці екстракційні (американська форма)  
 Pinzereper per estrazione - forma americana  
 استخراج الملقط (النمط الأمريكي)



**Article# W16-235**  
**#10 SK**  
 Upper Molars Sup



**Article# W16-236**  
**#17 SK Universal**  
 Lower Molars



**Article# W16-237**  
**#23 SK Universal**  
 Upper Molars



**Article# W16-238**  
**#69 SK Tomas**  
 upper and lower roots



Straight extracting forceps for upper incisors and canines



Straight extracting forceps for upper incisors and canines



Straight extracting forceps for upper incisors and canines



**Article# W16-239**  
**#99 SK**  
 upper incisors,  
 canines, premolars



**Article# W16-240**  
**#150 SK**  
 upper incisors,  
 premolars, roots



**Article# W16-241**  
**#151 SK**  
 lower incisors,  
 premolars, roots



**Article# W16-242**  
**#222 SK**  
 lower third molars

Щипцы экстракционные (американская форма)  
Daviers - forme americane  
Fórceps de extracción - forma americana

Щипці екстракційні (американська форма)  
Pinzeper per estrazione - forma americana  
ستخراج الملقط (النمط الأمريكي)



**Article# W16-243**  
Fig. 1  
Upper Anterior



**Article# W16-244**  
Lower Molar  
Fig. 23 Cow Horn



**Article# W16-245**  
Fig. 88L  
Upper Molar Left



**Article# W16-246**  
Fig. 88R  
Upper Molar Right



**Article# W16-247**  
Fig. 150  
Upper Universal



**Article# W16-248**  
Fig. 150S  
Upper Universal



**Article# W16-249**  
Fig. 151  
Lower Universal



**Article# W16-250**  
Fig. 151S  
Lower Universal



**Article# W16-251**  
Fig. 106  
Lower Incisors



**Article# W16-252**  
Fig. 174  
Extra Narrow Lower Anterior  
Apical Retention Forceps

**EXTRACTING FORCEPS  
SECTION 6**

- Шприцы стоматологические карпульные
- Шприцы стоматологічні карпульні
- Seringues à usage dentaire
- Jeringas dentales
- Dentalspritzen
- المحاقن الأسنان

EXTRACTING FORCEPS



Type C  
**Article#**  
WI6-253 1,8ml  
WI6-254 2,2ml



Type C  
**Article#**  
WI6-255 1,8ml  
WI6-256 2,2ml



Type C  
**Article#**  
WI6-257 1,8ml  
WI6-258 2,2ml



**Article# WI6-259**  
Aspirated Dental Cartridge  
Syringe 1.8 ml



**Article# WI6-260**  
Aspirated Dental Cartridge  
Syringe Folding Style 1.8 ml



**Article# WI6-261**  
Aspirated Dental Cartridge  
Syringe Folding Style 1.8 ml

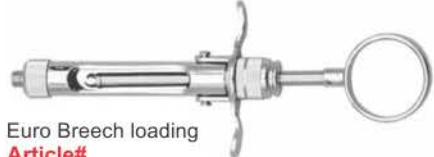

Euro Breech loading  
**Article#**  
WI6-262 1,8ml  
WI6-263 2,2ml

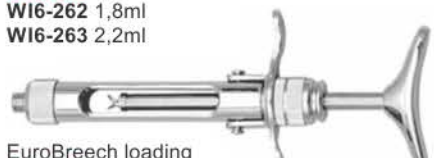

EuroBreech loading  
**Article#**  
WI6-264 1,8ml  
WI6-265 2,2ml



**Article#**  
WI6-266 1,8ml  
WI6-267 2,2ml



**Article# WI6-268**  
Aspirated Dental Cartridge  
Syringe Folding Style 1.8 ml



Aspirating Syringe  
**Article#**  
WI6-269 1.8mm  
WI6-270 2.2mm



**Article#**  
WI6-271 1.8mm  
WI6-272 2.2mm



Aspirating Syringe  
**Article#**  
WI6-273 1.8mm  
WI6-274 2.2mm



2-Ring  
**Article#**  
WI6-275 1,8ml  
WI6-276 2,2ml



Aspirating Syringe  
**Article#**  
WI6-277 1.8mm  
WI6-278 2.2mm



2-Ring  
**Article#**  
WI6-279 1,8ml  
WI6-280 2,2ml



Catridge Syringe  
**Article#**  
WI6-281 1.8mm  
WI6-282 2.2mm



Catridge Syringe  
**Article#**  
WI6-283 1.8mm  
WI6-284 2.2mm



Catridge Syringe  
**Article#**  
WI6-285 1.8mm  
WI6-286 2.2mm



**Article#**  
WI6-287 1.8ml  
WI6-288 2.2ml



Manual Aspirating Syringe  
**Article#**  
WI6-289 1.8ml  
WI6-290 2.2ml



Manual Aspirating Syringe  
**Article#**  
WI6-291 1,8ml  
WI6-292 2,2ml



Quatro  
**Article#**  
WI6-293 1,8ml  
WI6-294 2,2ml



Trio  
**Article#**  
WI6-295 1,8ml  
WI6-296 2,2ml



**Article#**  
WI6-297 1.8ml  
WI6-298 2.2ml



**Article#**  
WI6-299 1.8ml  
WI6-300 2.2ml

**EXTRACTING FORCEPS  
SECTION 6**

■ Шприцы стоматологические карпульные  
■ Seringues à usage dentaire  
■ Dentalspritzen

■ Шприці стоматологічні карпульні  
■ Jeringas dentales  
■ المحاقن الأسنان

EXTRACTING FORCEPS



Disc System  
**Article#**  
W16-301 1.8ml  
W16-302 2.2ml



Disc System  
**Article#**  
W16-303 1.8ml  
W16-304 2.2ml



Disc System  
**Article#**  
W16-305 1.8ml  
W16-306 2.2ml



Projection System  
**Article#**  
W16-307 1.8ml  
W16-308 2.2ml



Projection System  
**Article#**  
W16-309 1.8ml  
W16-310 2.2ml



**Article# W16-311**  
Dental Anesthesia Syringe  
1.8 ml (in Multi Colors)



**Article# W16-312**  
Dental Anesthesia Syringe  
1.8 ml (in Multi Colors)



**Article# W16-313**  
Dental Anesthesia Syringe  
1.8 ml (in Multi Colors)



**Article# W16-314**  
Suitable For Use With All  
1.8ml Dental Cartridges



**Article# W16-315**  
Suitable For Use With All  
1.8ml Dental Cartridges



**Article#**  
W16-316 1.8ml  
W16-317 2.2ml  
Angled



Ject Ultima  
**Article#**  
W16-318 1,8ml  
W16-319 2,2ml  
Injects 0,05 ml with every click Supplied with  
angled and straight tubes



Ject angled  
**Article#**  
W16-320 1,8ml  
W16-321 2,2ml



Ject straight  
**Article#**  
W16-322 1,8ml  
W16-323 2,2ml



Swedish Type  
**Article#**  
W16-324 1,8ml  
W16-325 2,2ml



**Article# W16-326**  
# 1001  
Intraligamental  
Anesthesia  
Syringe in  
Black Colour



**Article#**  
W16-327 1.8ml  
W16-328 2.2ml

**WITTEX**  
INTERNATIONAL

Aluminium - Dark  
**Article#**  
W16-329 1.8 ml  
W16-330 2.2 ml

Aluminium - Silver  
**Article#**  
W16-331 1.8 ml  
W16-332 2.2 ml

Aluminium - Orange  
**Article#**  
W16-333 1.8 ml  
W16-334 2.2 ml

Aluminium - Green  
**Article#**  
W16-335 1.8 ml  
W16-336 2.2 ml

Aluminium - Blue  
**Article#**  
W16-337 1.8 ml  
W16-338 2.2 ml

DENTAL MICRO SURGERY & INSTRUMENTS

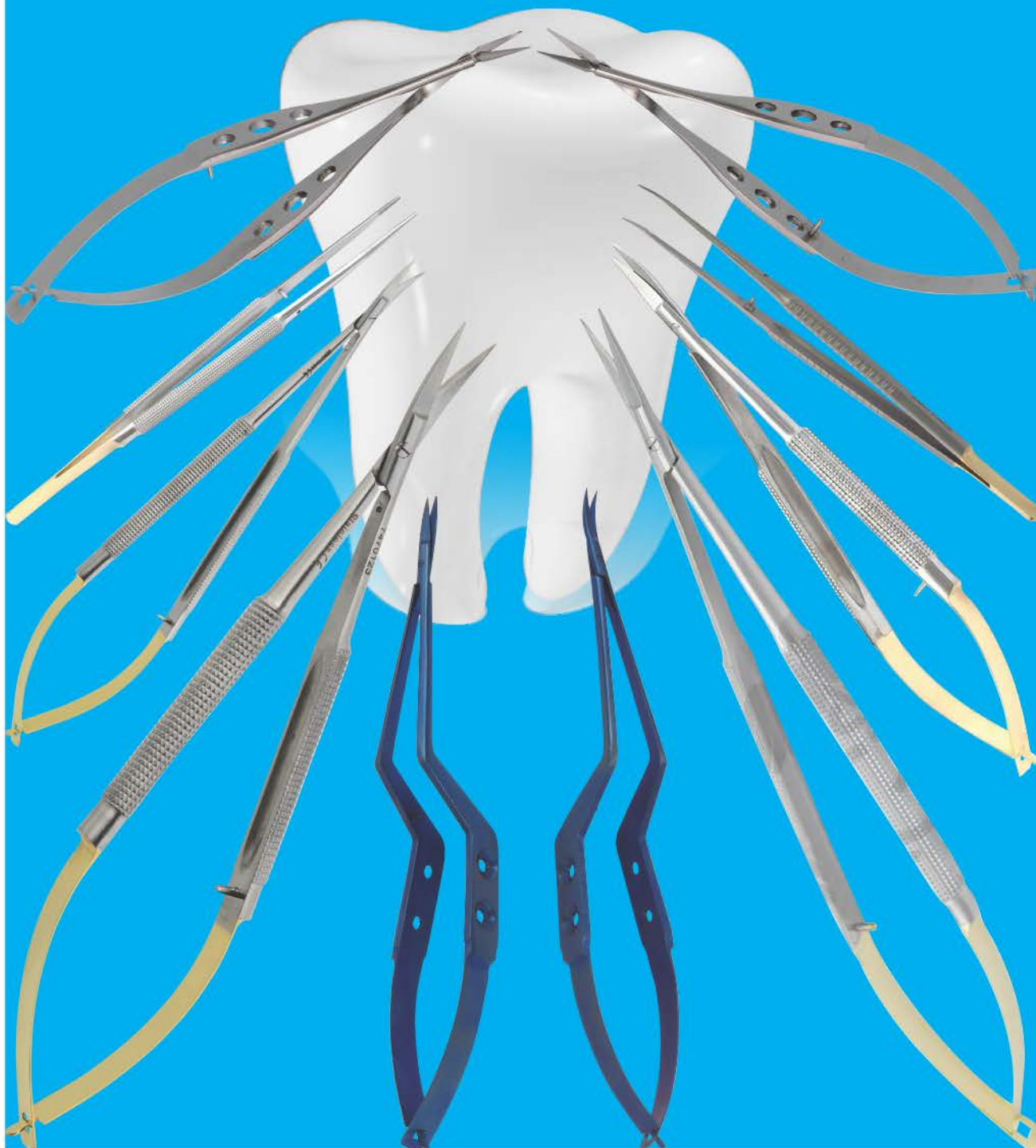

DENTAL MICRO SURGERY

- Ручки для скальпелей
- Ручки для скальпелів
- Manches de bistouris
- Mangos de bisturi
- Skalpellgriffe
- مشرط مقابض



**Article#**  
**WI7-001**  
Fig. 3  
12.5cm



**Article#**  
**WI7-002**  
Fig. 3  
12.5cm



**Article#**  
**WI7-003**  
Fig. 7  
16.5cm



**Article#**  
**WI7-004**  
Fig. 5  
14.5cm



**Article#**  
**WI7-005**  
Fig. 5A  
14.5cm



**Article#**  
**WI7-006**  
Fig. 3L  
21cm



**Article#**  
**WI7-007**  
Fig. 4L  
21.8cm



**Article#**  
**WI7-008**  
Fig. 4  
13.5cm



**Article#** WI7-009  
Double Handle  
No.4 + No.3  
16.3cm



**Article#** WI7-010  
6 Way Adjustable  
Angled  
Scalpel Handle



**Article#** WI7-011  
Scalpel Handle  
movable



**Article#** WI7-012  
Scalpel Handle  
Auto Push Blade



**Article#** WI7-013  
Scalpel Handle straight,  
for blades # 10 -15, 14.5 cm



**Article#** WI7-014  
Micro Surgical  
Scalpel Handle

Ножи для скальпеля и скальпеля  
Blalpel Blade & Scalpel Knives  
Scalpel Blade & Scalpel Messer

Ножи скальпельного леза та скальпеля  
Cuchillos de Escalpel y Escalpel  
مشرط شفرة و مشرط السكاكين

**STERIL SCALPEL BLADES**



**Article#**  
**WI7-015**  
10



**Article#**  
**WI7-016**  
11



**Article#**  
**WI7-017**  
20



**Article#**  
**WI7-018**  
21



**Article#**  
**WI7-019**  
22

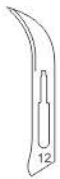

**Article#**  
**WI7-020**  
12



**Article#**  
**WI7-021**  
15

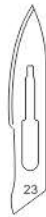

**Article#**  
**WI7-022**  
23



**Article#**  
**WI7-023**  
24



**Article#**  
**WI7-024**  
16.5cm



Kit of scalpel blade  
remover and orientable  
blade scalpel handle

**SCALPEL KNIVES**



**DIEFFENBACH**  
12.5cm



**Article#**  
**WI7-025**  
Fig. 1  
12.5cm



**Article#**  
**WI7-026**  
Fig. 2  
13cm



**Article#**  
**WI7-027**  
Fig. 4  
13.5cm



**Article#**  
**WI7-028**  
Fig. 5  
14cm



**Article#**  
**WI7-029**  
Fig. 7  
12.5cm



**Article#**  
**WI7-030**  
Fig. 8  
13cm



**Article#**  
**WI7-031**  
Fig. 9  
13.5cm



**Article#**  
**WI7-032**  
Fig. 10  
14cm

- Скальпельные ножи    ■ Ножи скальпеля
- Couteaux à scalpel    ■ Cuchillos Scalpel
- Skalpelmesser        ■ سكاكين مشرط

DENTAL MICRO SURGERY



**Dieffenbach**  
16cm



**Article#**  
**WI7-033**  
Fig. 1  
16cm



**Article#**  
**WI7-034**  
Fig. 2  
16cm



**Article#**  
**WI7-035**  
Fig. 3  
16cm



**Article#**  
**WI7-036**  
Fig. 4  
16cm



**Article#**  
**WI7-037**  
Fig. 5  
16cm



**Article#**  
**WI7-038**  
Fig. 6  
16cm



**Article#**  
**WI7-039**  
Fig. 7  
16cm



**Article#**  
**WI7-040**  
Fig. 8  
16cm



**Article#**  
**WI7-041**  
Fig. 9  
16cm



**Article#**  
**WI7-042**  
Fig. 10  
16cm



**Article#** **WI7-043**  
Fig. 15  
16cm



**Article#** **WI7-044**  
Fig. 16  
16cm

MAXIOFACIAL SECTION 7

Ранорасширители  
Ecarteurs  
Wundhaken

Ранорозширювачі  
Separadores  
الكامشات



**Article# WI7-045**  
Stainless Steel Single Ended Cheek Retractors



**Article# WI7-046**  
Stainless Steel Double Ended Cheek Retractors



**Article# WI7-047**  
Cheek Retractor Stainless Steel Long



**Article# WI7-048**  
Dental Lip Retractor



**Article# WI7-049**  
Left



**Article# WI7-050**  
Straight  
Retractor Blue Titanium Coating



**Article# WI7-051**  
Right



**Article# WI7-052**  
Retractor  
Blue Titanium Coating



**Article# WI7-053**  
Stainless Steel Double Black & Gold Ended Cheek Retractors



**Article# WI7-054**  
Urban Cheek Retractor



**Article# WI7-055**  
University of Minneosta Retractor



**Article# WI7-056**  
Cawood Minnesota Cheek Retractor



**Article# WI7-057**  
Minnesota



**Article# WI7-058**  
Minnesota Cheek Retractor 15.5cm



**Article# WI7-059**  
Brunings Cheek Retractor 19cm



**Article# WI7-060**  
Cheek Retractor 20cm  
Easy to Bend by Hand

DENTAL MICRO SURGERY

MAXIOFACIAL SECTION 7

Инструменты для реставрации  
Instruments pour plombage  
Füllungsinstrumente (mit Kontrawinkel)

Инструменти для реставрації  
Instrumentos para obturaciones  
ملء الصكوك

DENTAL MICRO SURGERY



Article#  
WI7-061 10.5cm  
WI7-062 13.5cm  
Weitlaner Fig. 1



Article#  
WI7-063 10.5cm  
WI7-064 13.5cm  
Weitlaner Fig. 2



Article# WI7-065  
Mouth Gag Molt  
9cm for (Children)



Article# WI7-066  
Mouth Gag Molt  
11.5cm for (Adults)



Article# WI7-067  
Mouth Gag Molt  
14cm for (Adults)



Article#  
WI7-068 11cm  
WI7-069 13cm  
WI7-070 15cm  
Weitlander



Article# WI7-074  
Denhard  
12cm



Article# WI7-075  
Roser-Konig  
16cm



Article# WI7-076  
Roser-Konig  
19cm



Article#  
WI7-071 11cm  
WI7-072 13cm  
WI7-073 15cm  
Jennings



Article# WI7-077  
HMG  
Heister  
13cm



Heiss Retractor  
Article#  
WI7-078 10 cm  
Sharp 4:4  
WI7-079 10 cm  
Blunt 4:4



ALM Retractor  
Article#  
WI7-080 7 cm  
4 x 4 teeth sharp/blunt  
WI7-081 10 cm  
4 x 4 teeth sharp/blunt



Jansen Retractor  
Article#  
WI7-082 10 cm  
Sharp 3x3  
WI7-083 10 cm  
Blunt 3x3



Joll (Friedman)  
Article# WI7-084 15.5 cm  
Thyroid- and Vaginal Retractor

MAXIOFACIAL SECTION 7

- Роторасширители
- Ecarteurs - Ouvre-bouches
- Vestibulumabhalter / Mundspanner
- Роторозширювачі
- Separadores - Abre-bocas
- الكاشطات - الكمامات الفم

DENTAL MICRO SURGERY



**Article# W17-085**  
Vestibulum Retractor  
Upper & Lower, 160mm



**Article# W17-086**  
Columbia Cheek  
Retractor, 12cm



**Article# W17-087**  
Wangen Holder  
15cm, with or without  
lip protection



**Article# W17-088**  
Wangen Holder  
15cm, with  
or without lip protection



**Article# W17-089**  
Wangen Holder  
Wangen holder with dual  
function, 17cm



**Article# W17-090**  
Retractor with  
Ergo Grip  
24cm  
ergonomic handle



**Article# W17-091**  
Cheek Retractor  
Retractor Ivory  
Width adjustable  
& flexible, 20cm



**Article# W17-092**  
Cheek Retractor  
and Tongue  
Pushers Bishop with  
Comfortable Margin,  
16cm



**Article# W17-093**  
Cheek Retractor  
Combination  
25cm



**Article# W17-094**  
Cheek Retractor  
Long



**Article# W17-095**  
Cheek Retractor  
Long



**Article# W17-096**  
Cheek Retractor  
Long

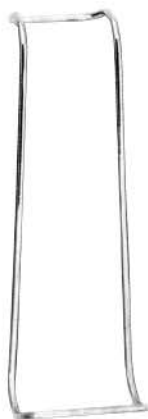

**Article# W17-097**  
Columbia  
14.5 cm



**Article# W17-098**  
Sternberg  
14 cm  
Double Ended



**Article# W17-099**  
Sternberg  
16 cm



**Article# W17-100**  
Sternberg  
14 cm  
Single Ended



**Article# W17-101**  
Oringer Medium  
11x8 cm

**MAXIOFACIAL  
SECTION 7**

Ранорасширители  
Ecarteurs  
Wundhaken

Ранорозширювачі  
Separadores  
الكامشات



**Article# WI7-102**  
Unique Retractor  
Length 17.5cm  
angled 45°



**Article# WI7-103**  
Unique Retractor  
Length 17.5cm  
angled 90°



**Article# WI7-104**  
Retractor  
16cm



**Article# WI7-105**  
Retractor  
19cm



**Article# WI7-106**  
75x75  
Austin Tissue  
Retractors



8cm  
Available with  
round tip on  
request

**Article# WI7-107**  
75x75  
Austin Tissue  
Retractors



**Article# WI7-108**  
14cm

**Article# WI7-109**  
15cm

Cheek Retractor



**Article# WI7-110**  
Farabeuf Retractor,  
120x12cm, Set of 2 pcs



**Article# WI7-111**  
Cheek Retractor  
Combination  
21cm, 2 Pcs



**Article# WI7-112**  
Mini-Langenbeck  
Retractor  
16cm, Hooks 22 mm



**Article# WI7-113**  
Senn Miller Retractor  
16cm Hooks 22 mm



**Article# WI7-114**  
Feldman  
Retractor 14cm



**Article# WI7-115** 30x11 mm  
**Article# WI7-116** 30x16 mm  
Langenbeck Retractor 21cm, hook



**Article# WI7-117**  
Seldin Retractor

**DENTAL MICRO SURGERY**

- Ранорасширители
- Ecarteurs
- Wundhaken
- Ранорозширювачі
- Separadores
- الكاشحات

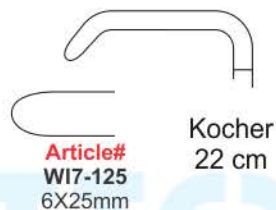
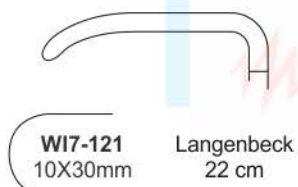
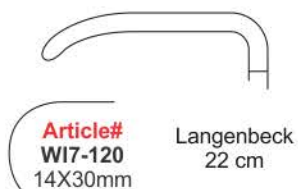
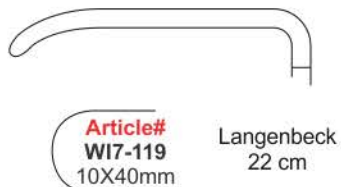
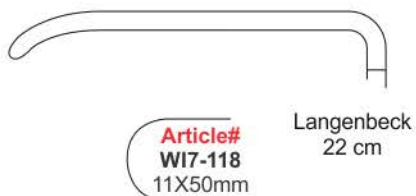

**Article# WI7-127**  
Kocher-Langenbeck Surgical Retractor, Downward Curve, 215mm, 11x35mm



**Article# WI7-128**  
Kocher-Langenbeck Surgical Retractor, Downward Curve, 215mm, 11x41mm



**Article# WI7-129**  
Kocher-Langenbeck Surgical Retractor, Downward Curve, 215mm, 11x55mm



Middeldorpf Retractor  
**Article#**  
**WI7-130** 17 cm  
**WI7-131** 22 cm

Иглодержатели  
Porte-aiguilles  
Nadelhalter

Голкотримачи  
Porta-agujas  
اصحاب ابرة

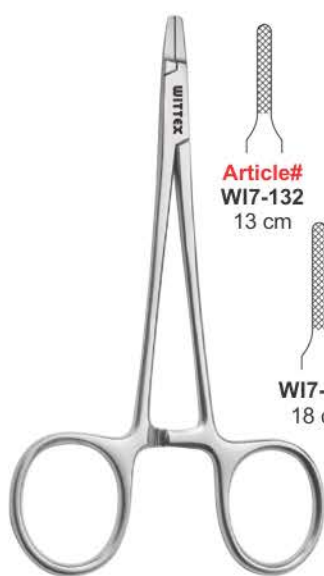

Castroviejo



Article# WI7-135  
Halsey  
13 cm

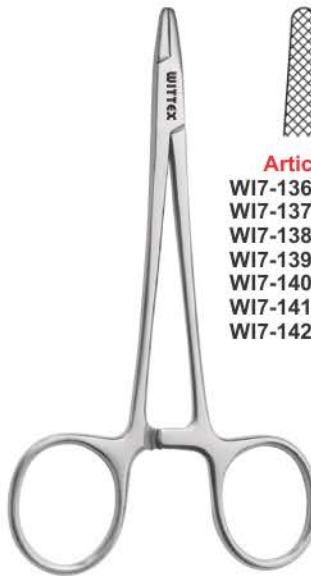

Baumgartner

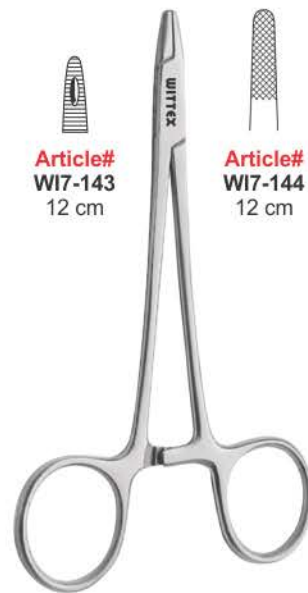

Derf

Article#  
WI7-132  
13 cm

Article#  
WI7-133  
15 cm

WI7-134  
18 cm

Article#  
WI7-136 13cm  
WI7-137 14cm  
WI7-138 16cm  
WI7-139 18cm  
WI7-140 20cm  
WI7-141 25cm  
WI7-142 30cm

Article#  
WI7-143  
12 cm

Article#  
WI7-144  
12 cm



Article#  
WI7-145  
Delicate  
15cm



Article#  
WI7-146  
Adson  
18cm



Mayo-Hegar  
Article#  
WI7-147 13cm  
WI7-148 14cm  
WI7-149 15cm  
WI7-150 16cm  
WI7-151 18cm  
WI7-152 20cm  
WI7-153 23cm  
WI7-154 24cm  
WI7-155 26cm  
WI7-156 30cm  
Serrated Grooved



Crile-Wood  
Article#  
WI7-157 15cm  
WI7-158 18cm  
WI7-159 20cm  
WI7-160 22cm  
WI7-161 25cm

Пинцеты  
Précelles - Brucelles  
Zahnpinzetten

Пінцети  
Pinzas para algodón  
ملاقط

TISSUE MEMBRANE FORCEPS



**Article# WI7-162**  
Russian Long Tissue Forceps Serrated Tip  
20cm

**Article# WI7-163**  
Russian Tissue Forceps Serrated Tip  
15cm

**Article# WI7-164**  
Tissue Punch Forceps To Remove Tissue After Using Punch  
15cm

**Article# WI7-165**  
Narrow  
13.5cm

**Article# WI7-166**  
10.5cm  
Membrane Tweezers Kuehne

**Article# WI7-167**  
wide  
13.5cm

**Article# WI7-168**  
Bishop Harman Micro Tissue Forcep  
8.6cm 1x2 Teeth - 0.3mm Tips



**Article# WI7-169**  
Pin-Tweezers length 15cm with lock

**Article# WI7-170**  
without lock  
15cm

**Article# WI7-171**  
Haltepinzette with lock  
15.5cm, for pins, towards the tips, etc

**Article# WI7-172**  
Carry Forceps  
15cm

**Article# WI7-173**  
Carry Forceps  
15cm

**Article# WI7-174**  
Carry Forceps  
15cm

MAXIOFACIAL SECTION 7

Пинцеты  
Précettes - Brucelles  
Zahnpinzetten

Пінцети  
Pinzas para algodón  
ملاقط

DENTAL MICRO SURGERY



Article# WI7-175  
London College  
15cm



Article# WI7-176  
Meriam  
16cm



Semken Taylor  
Article# WI7-177 12.5cm  
WI7-178 15cm  
Straight



Semken Taylor  
Article# WI7-179 12.5cm  
WI7-180 15cm  
Curved



Semken Taylor  
Article# WI7-181 12.5cm  
WI7-182 15cm  
1x2 Straight



Semken Taylor  
Article# WI7-183 12.5cm  
WI7-184 15cm  
1x2 Curved



Article# WI7-185  
Flagg  
15cm



Article# WI7-186  
Meriam  
16cm



Article# WI7-187  
Amsterdam  
15.5cm



Article# WI7-188  
Perry  
13cm  
Curved



Article# WI7-189  
Self-Locking  
15cm  
Angled



Article# WI7-190  
Endo-Locking  
Grooved  
15cm

MAXIOFACIAL SECTION 7

Пинцеты  
Précettes - Brucelles  
Zahnpinzetten

Пинцети  
Pinzas para algodón  
ملاقط



**Article#**  
WI7-191  
15 cm  
Fig. 1  
Thin Pattern



**Article#**  
WI7-192  
15 cm  
Fig. 2  
Wide Pattern



**Article#**  
WI7-193  
16 cm



**Article#**  
WI7-194  
15 cm  
Fig. 1



**Article#**  
WI7-195  
15 cm  
Fig. 2



**Article#**  
WI7-196  
11.5 cm  
Fig. 1

Micro Surgery Instrument



**Article#**  
WI7-197  
15cm  
College



**Article#**  
WI7-198  
Meriam  
15cm



**Article#**  
WI7-199  
De Backy  
Atraumatic  
15cm Straight



**Article#**  
WI7-200  
Meriam Tweezers  
smooth 16cm



**Article#**  
WI7-201  
London College  
smooth 16cm



Adson With Teeth  
**Article#**  
WI7-202 12cm  
WI7-203 15cm



Пинцеты  
Précelles - Brucelles  
Zahnpinzetten

Пінцети  
Pinzas para algodón  
ملاقط



**Article#**  
WI7-204  
Perry  
10.5 cm



**Article#**  
WI7-205  
Perry  
10.5 cm



**Article#**  
WI7-206  
Fig. 1  
Perry  
13 cm



**Potts-Smith Dressing Forceps**  
**Article#**  
WI7-207 18 cm  
WI7-208 20 cm  
WI7-209 25 cm  
straight serrated



**Potts-Smith Dressing Forceps**  
**Article#**  
WI7-210 18 cm  
WI7-211 20 cm  
WI7-212 25 cm  
curved serrated



**Potts-Smith Tissue Forceps 1x2 teeth**  
**Article#**  
WI7-213 18 cm  
WI7-214 20 cm  
WI7-215 25 cm  
straight



**Potts-Smith Tissue Forceps 1x2 teeth**  
**Article#**  
WI7-216 18 cm  
WI7-217 20 cm  
WI7-218 25 cm  
curved



**De-Bakey With Tungsten Carbide (TC)** 17.5cm  
**Article#** WI7-219



**Adson**  
**Article#**  
WI7-220 12cm  
WI7-221 15cm



**Adson 1x2**  
**Article#**  
WI7-222 12cm  
WI7-223 15cm



**Adson Brown**  
**Article#**  
WI7-224 12cm  
WI7-225 15cm



**Article#**  
WI7-226  
Crane Kaplan  
15cm



**Article#**  
WI7-227  
Hemingway  
15cm

MAXIOFACIAL SECTION 7

■ Пинцеты для удаления осколков  
■ Pincès à souder - Pincès et pincès à échardes  
■ Löt-Zange - Pinzette & SplinterZange

■ Пінцети для видалення осколків  
■ Alicates Soldadura - Pinzas y pinzas de Splinter  
■ لحام كماشة - ملاقط منشقة الملقط



Article# WI7-228  
Soldering Pliers  
16cm



Article# WI7-229  
Soldering Pliers  
16cm



Article# WI7-230  
Posigrip Articulating  
Paper Forceps  
15cm



Article# WI7-231  
Standard Articulating  
Paper Forceps, Economy Grade  
15cm



Article# WI7-232  
Miller 15cm  
Curved



Beer Cilia Forceps  
Article# WI7-233  
9 cm



Kuehne Cilia Forceps  
Article# WI7-234  
10.5 cm



Kuehne Cilia Forceps  
Article# WI7-235  
10.5 cm  
angled sideways

DENTAL MICRO SURGERY

Пинцеты  
Précettes - Brucelles  
Zahnpinzetten

Пінцети  
Pinzas para algodón  
ملاقط

**TISSUE MEMBRANE FORCEPS**



**Article# WI7-236**  
Tissue Graft Forcep  
Serrated Teeth  
15cm



**Article# WI7-237**  
Self Locking  
Grooved  
15cm



**Article# WI7-238**  
Tissue Graft Forcep  
Serrated Teeth  
15cm



**Article# WI7-239**  
Titanium Metal  
Locking Plier



**Article# WI7-240**  
TC Gripper Carbide  
Tipped Tissue Forceps  
Serrated Carbide Tips  
14.5cm



**Article# WI7-241**  
Adson Carbide  
Tipped Tissue Forceps  
Serrated Carbide Tips  
12cm



**Article# WI7-242**  
Chalazion Mucocele  
Forceps  
9cm Length  
12mm x 23mm  
Inside Ring



**Article# WI7-243**  
Micor Adson  
Tissue Forcep 12cm  
1x2 Teeth -  
0.5mm Tips



**Article# WI7-244**  
Adson 7x7  
Tissue Forceps  
7x7 Teeth  
12cm



**Article# WI7-245**  
Adson 7x7 Curved  
Tissue Forceps  
7x7 Teeth 12cm



**Article# WI7-246**  
Suture Pliers  
Suture Forceps  
with  
1.6mm Ring Tip  
16cm



**Article# WI7-247**  
Membrane Forcep  
With Delicate  
Ring Tip  
10 cm



**Article# WI7-248**  
Debakey Atraumatic  
Tissue Forceps  
Straight  
Serrated Teeth  
16cm



**Article# WI7-249**  
Debakey Atraumatic  
Tissue Forceps Curved  
Serrated Teeth  
16cm

Иглодержатели  
Porte-aiguilles  
Nadelhalter

Голкотримачи  
Porta-agujas  
اصحاب ابرة

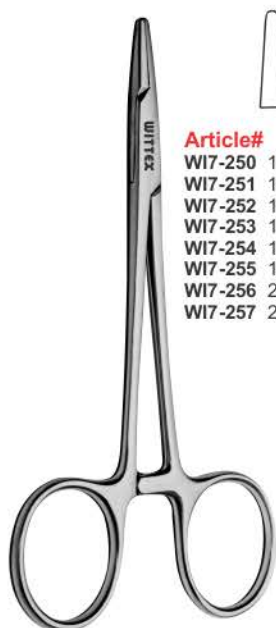

Webster Needle Holder

**Article#**  
W17-250 11 cm Smooth  
W17-251 12 cm Smooth  
W17-252 13 cm Smooth  
W17-253 14 cm Smooth  
W17-254 16 cm Smooth  
W17-255 18 cm Smooth  
W17-256 20 cm Smooth  
W17-257 23 cm Smooth



Heaney Needle Holders

**Article#**  
W17-258 20 cm Cvd.  
W17-259 27 cm Cvd.



Crile-Murray Needle Holders

**Article#**  
W17-260 15 cm  
W17-261 18.5 cm Slender pattern



Doyen Needle Holders

**Article#**  
W17-262 12.5 cm

DENTAL MICRO SURGERY



Olsen-Hegar Needle Holder With Scissors 14cm

**Article#**  
W17-263 12 cm  
W17-264 14 cm  
W17-265 17 cm  
W17-266 19 cm

**Article#**  
W17-267 12 cm smooth  
W17-268 14 cm smooth  
W17-269 17 cm smooth  
W17-270 19 cm smooth



Olsen-Hegar Needle Holder With Scissors 14cm

**Article#**  
W17-271 12 cm  
W17-272 14 cm  
W17-273 17 cm  
W17-274 19 cm

**Article#**  
W17-275 12 cm smooth  
W17-276 14 cm smooth  
W17-277 17 cm smooth  
W17-278 19 cm smooth



W17-279 Gillies Needle Holder With Scissors 16cm

Иглодержатели  
Porte-aiguilles  
Nadelhalter

Голкотримачи  
Porta-agujas  
اصحاب ابرة



Kilner Needle Holders



Article#  
W17-280  
13 cm  
serrated



Crile  
Article# W17-281  
15 cm



Toennis  
Article# W17-282  
18 cm



Mathieu



Article#  
W17-283  
14 cm



Article#  
W17-284  
17 cm



Article#  
W17-285  
20 cm



Mathieu



Article#  
W17-286  
14 cm



Article#  
W17-287  
17 cm



Article#  
W17-288  
20 cm



Mathieu



Article#  
W17-289  
14 cm



Article#  
W17-290  
17 cm



Article#  
W17-291  
20 cm



Mathieu



Article#  
W17-292  
14 cm



Article#  
W17-293  
17 cm



Article#  
W17-294  
20 cm

Иглодержатели  
Porte-aiguilles  
Nadelhalter

Голкотримачи  
Porta-agujas  
اصحاب ابرة

T.C GOLD



**Article#**  
W17-295 13cm  
W17-296 15cm  
W17-297 18cm  
W17-298 20cm

Crile-Ryder T.C



**Article#** W17-299  
Halsey  
12.5cm



Baumgartner

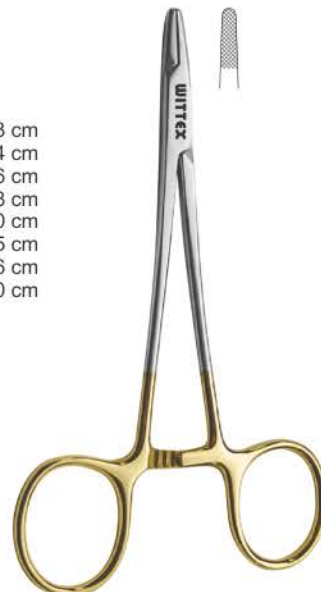

**Article#** W17-308  
Derf  
12 cm

**Article#**  
W17-300 13 cm  
W17-301 14 cm  
W17-302 16 cm  
W17-303 18 cm  
W17-304 20 cm  
W17-305 25 cm  
W17-306 26 cm  
W17-307 30 cm



**Article#** W17-309  
Delicate  
15 cm



Mayo-Hegar  
**Article#**  
W17-310 13cm  
W17-311 16cm  
W17-312 18cm  
W17-313 20cm



Crile-Wood  
**Article#**  
W17-314 15cm  
W17-315 17cm  
W17-316 20cm  
W17-317 22cm  
W17-318 25cm  
straight



Crile-Wood  
**Article#**  
W17-319 15cm  
W17-320 17cm  
W17-321 20cm  
W17-322 22cm  
W17-323 25cm  
Curved

Иглодержатели  
Porte-aiguilles  
Nadelhalter

Голкотримачи  
Porta-agujas  
اصحاب ابرة

T.C GOLD



Mathieu-Kocher

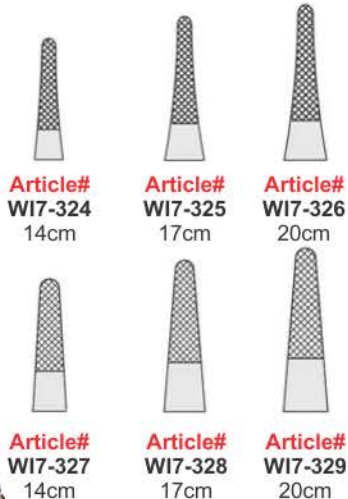

Article# WI7-324  
14cm

Article# WI7-325  
17cm

Article# WI7-326  
20cm

Article# WI7-327  
14cm

Article# WI7-328  
17cm

Article# WI7-329  
20cm



Mathieu



Article# WI7-330  
14cm

Article# WI7-331  
17cm

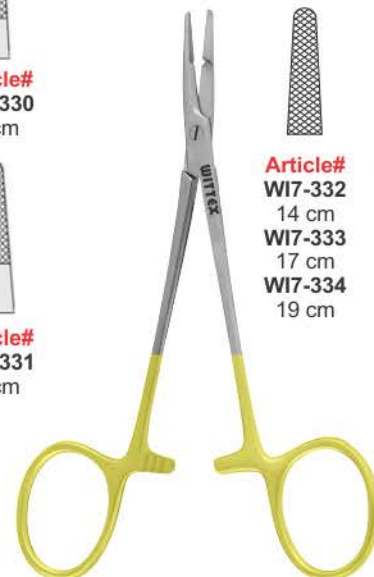

Olsen-Hegar Needle Holder With Scissors T.C

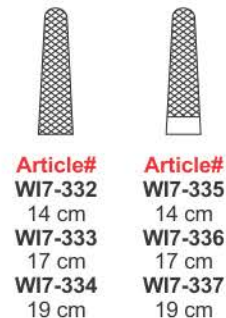

Article# WI7-332  
14 cm  
WI7-333  
17 cm  
WI7-334  
19 cm

Article# WI7-335  
14 cm  
WI7-336  
17 cm  
WI7-337  
19 cm



Olsen-Hegar Needle Holder With Scissors

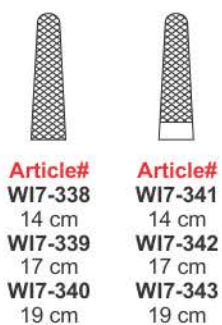

Article# WI7-338  
14 cm  
WI7-339  
17 cm  
WI7-340  
19 cm

Article# WI7-341  
14 cm  
WI7-342  
17 cm  
WI7-343  
19 cm



Article# WI7-344  
Gillies Needle Holder With Scissors  
16cm



Castroviejo  
Article# WI7-345 14cm straight  
WI7-346 18cm straight  
WI7-347 14cm curved  
WI7-348 18cm curved



Castroviejo  
Article# WI7-349 14cm straight  
WI7-350 18cm straight  
WI7-351 14cm curved  
WI7-352 18cm curved

■ Стерилизационные и тканевые зажимы  
■ Stérilisation et pinces pour tissus  
■ Esterilizadores y sujetadores de tejidos

■ Стерилізаційні та тканинні зажимки  
■ Esterilização e grampos de tecido  
■ تعقيم & المشابك الأنسجة

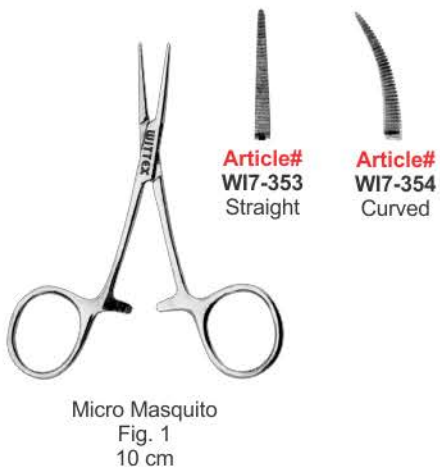

- Зажимы артериальные
- Затискачі артеріальні
- Pincas hemostatiques
- Pinzas hemostaticas
- Arterienklemmen
- ملقط هایموستاتیک



Hartmann (Baby Mosquito)  
**Article#**  
**WI7-364** 10 cm straight  
**WI7-365** 10 cm curved



Halstead Mosquito  
**Article#**  
**WI7-366** 10cm  
**WI7-367** 12.5cm  
**WI7-368** 14cm  
 straight  
**WI7-369** 10cm  
**WI7-370** 12.5cm  
**WI7-371** 14cm  
 curved



Halstead Mosquito 1x2  
**Article#**  
**WI7-372** 10cm  
**WI7-373** 12.5cm  
**WI7-374** 14cm  
 straight  
**WI7-375** 10cm  
**WI7-376** 12.5cm  
**WI7-377** 14cm  
 Curved



Kelly  
**Article#**  
**WI7-378** 14cm  
**WI7-379** 16cm  
**WI7-380** 18cm  
**WI7-381** 20cm  
**WI7-382** 22cm  
**WI7-383** 24cm  
 straight  
**Article#**  
**WI7-384** 14cm  
**WI7-385** 16cm  
**WI7-386** 18cm  
**WI7-387** 20cm  
**WI7-388** 22cm  
**WI7-389** 24cm  
 curved



Rochester-Pean  
**Article#**  
**WI7-390** 14cm  
**WI7-391** 16cm  
**WI7-392** 18cm  
**WI7-393** 20cm  
**WI7-394** 22cm  
**WI7-395** 24cm  
**WI7-396** 26cm  
**WI7-397** 28cm  
**WI7-398** 30cm  
 straight  
**Article#**  
**WI7-319** 14cm  
**WI7-400** 16cm  
**WI7-401** 18cm  
**WI7-402** 20cm  
**WI7-403** 22cm  
**WI7-404** 24cm  
**WI7-405** 26cm  
**WI7-406** 28cm  
**WI7-407** 30cm  
 curved



Rochester-Kocher 1x2  
**Article#**  
**WI7-408** 14cm  
**WI7-409** 16cm  
**WI7-410** 18cm  
**WI7-411** 20cm  
**WI7-412** 22cm  
**WI7-413** 24cm  
**WI7-414** 26cm  
**WI7-415** 28cm  
**WI7-416** 30cm  
 straight  
**Article#**  
**WI7-417** 14cm  
**WI7-418** 16cm  
**WI7-419** 18cm  
**WI7-420** 20cm  
**WI7-421** 22cm  
**WI7-422** 24cm  
**WI7-423** 26cm  
**WI7-424** 28cm  
**WI7-425** 30cm  
 curved



Kelly-Rankin  
**Article#**  
**WI7-426** 16 cm  
 straight  
**WI7-427** 16 cm  
 curved

- Ножницы десневые
- Ciseaux a gencives
- Zahnfleischscheren
- Ножіці для ясен
- Tijeras para encias
- مقص صمغ

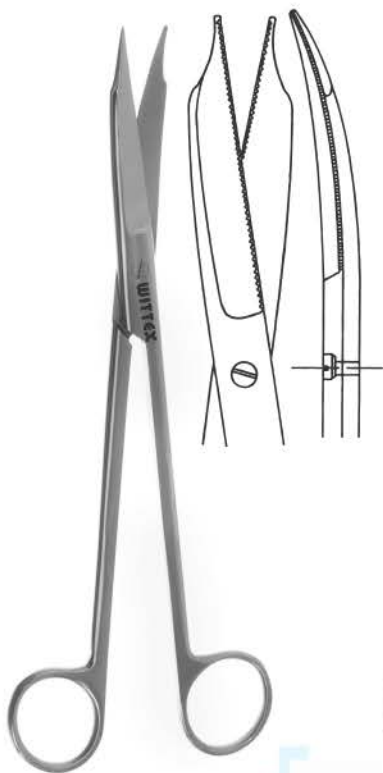

**Martin-Cartilage Scissors**  
**Article# WI7-428** 20 cm  
 S/S Serrated



**Mc Indoe Scissors**  
**Article# WI7-429** 19 cm  
 S/S Str.

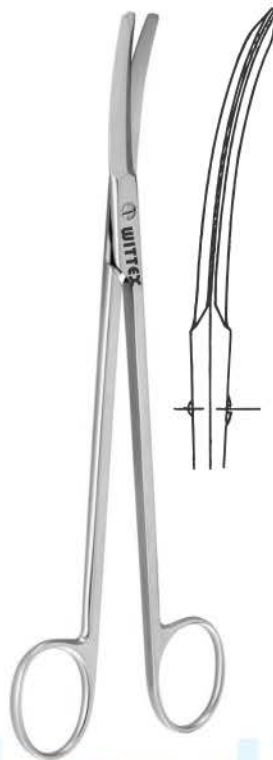

**Potts-Smith Scissors**  
**Article# WI7-430** 19 cm  
 B/B Cvd.

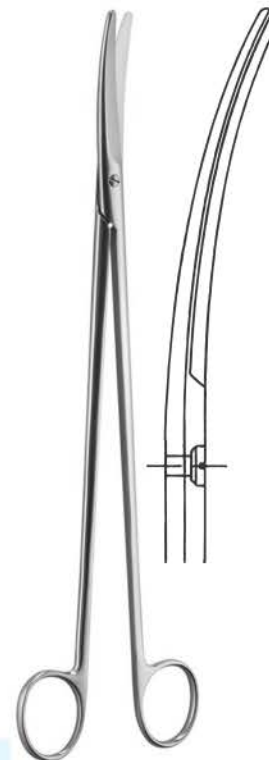

**Craford Scissors**  
**Article# WI7-431** 30 cm  
 B/B Cvd.



**Article#**  
**WI7-432**  
 10 cm  
**WI7-433**  
 11 cm  
 S/S Str.

**Stevens Scissors**



**Article#**  
**WI7-434**  
 10 cm  
**WI7-435**  
 11 cm  
 S/S Cvd.

**Stevens Scissors**

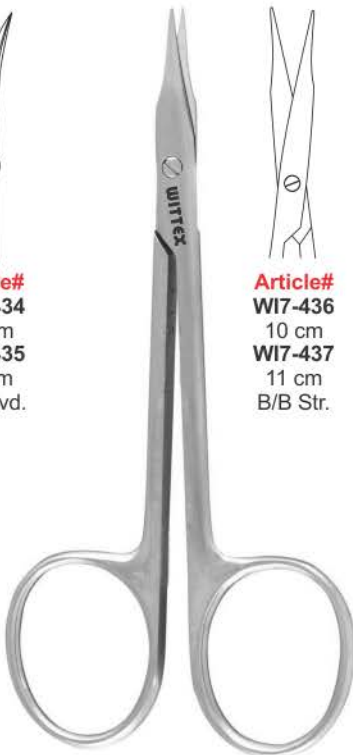

**Article#**  
**WI7-436**  
 10 cm  
**WI7-437**  
 11 cm  
 B/B Str.

**Article#**  
**WI7-438**  
 10 cm  
**WI7-439**  
 11 cm  
 B/B Cvd.



**Graefe Scissors**  
**Article# WI7-440** 10.5 cm  
 B/B Angled

MAXIOFACIAL SECTION 7

- Ножницы десневые
- Ciseaux a gencivas
- Zahnfleischscheren
- 口香糖剪刀
- Ножіці для ясен
- Tijeras para encias
- مقص صمغ

DENTAL MICRO SURGERY

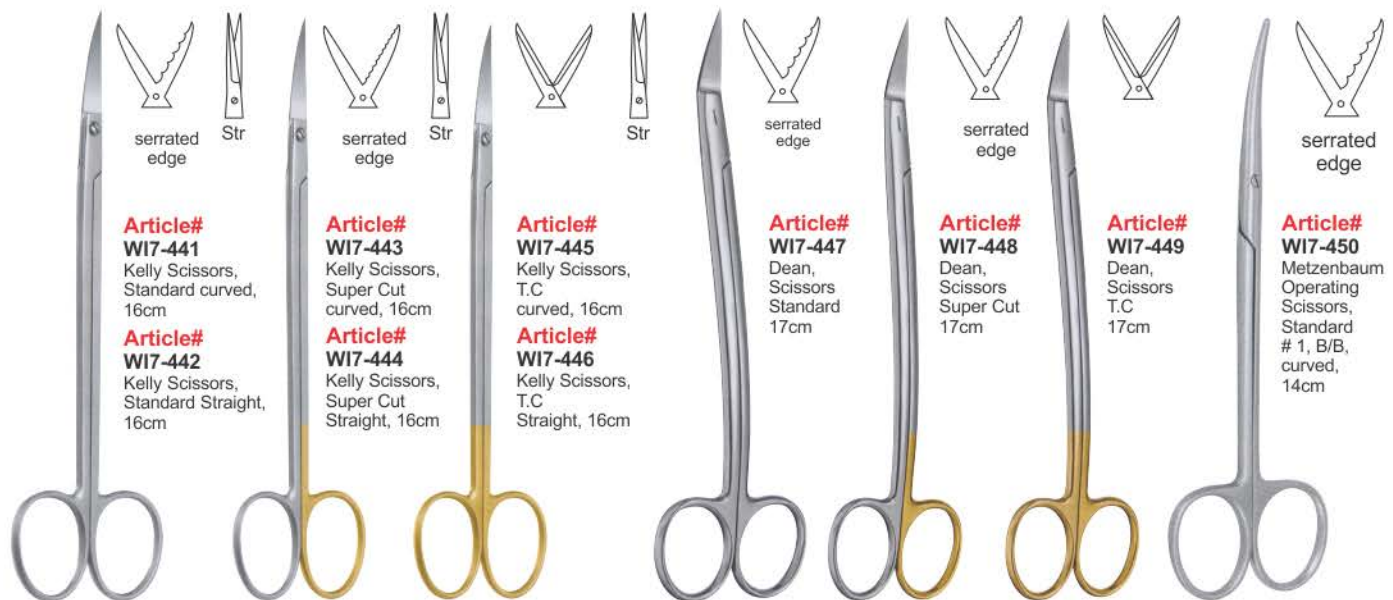

**Article#**  
**W17-441**  
Kelly Scissors,  
Standard curved,  
16cm

**Article#**  
**W17-442**  
Kelly Scissors,  
Standard Straight,  
16cm

**Article#**  
**W17-443**  
Kelly Scissors,  
Super Cut  
curved, 16cm

**Article#**  
**W17-444**  
Kelly Scissors,  
Super Cut  
Straight, 16cm

**Article#**  
**W17-445**  
Kelly Scissors,  
T.C  
curved, 16cm

**Article#**  
**W17-446**  
Kelly Scissors,  
T.C  
Straight, 16cm

**Article#**  
**W17-447**  
Dean,  
Scissors  
Standard  
17cm

**Article#**  
**W17-448**  
Dean,  
Scissors  
Super Cut  
17cm

**Article#**  
**W17-449**  
Dean,  
Scissors  
T.C  
17cm

**Article#**  
**W17-450**  
Metzenbaum  
Operating  
Scissors,  
Standard  
# 1, B/B,  
curved,  
14cm

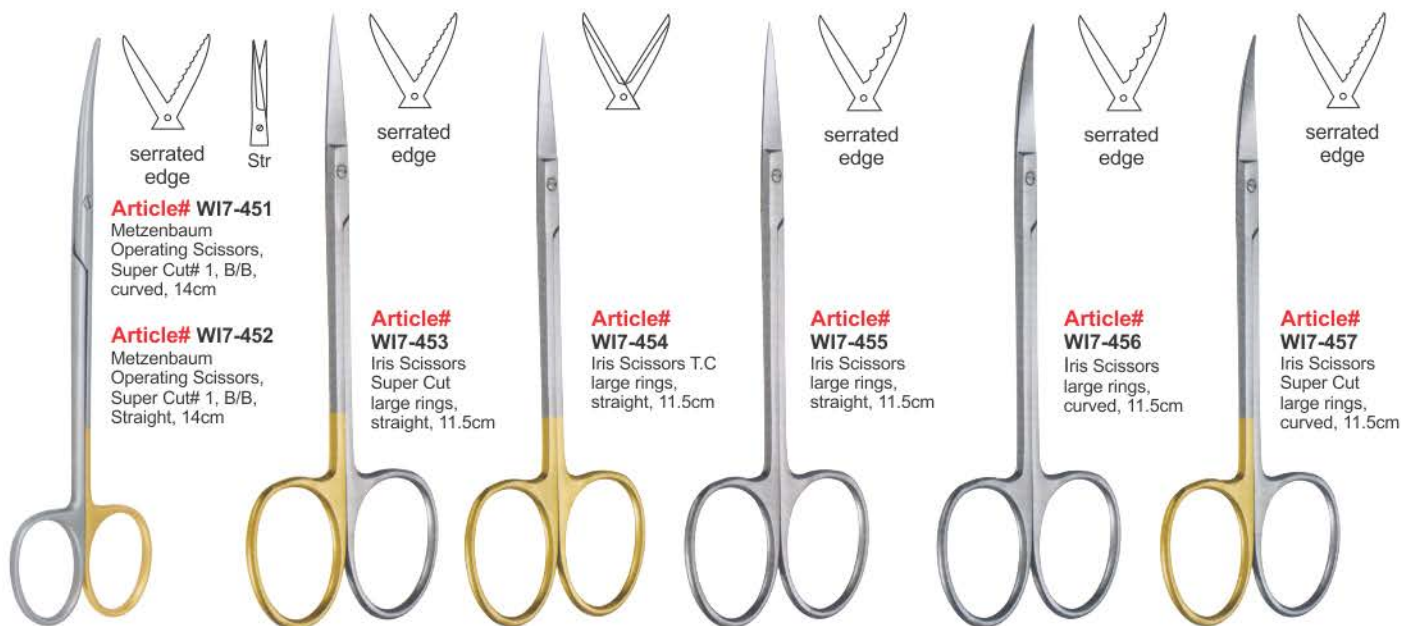

**Article#**  
**W17-451**  
Metzenbaum  
Operating Scissors,  
Super Cut# 1, B/B,  
curved, 14cm

**Article#**  
**W17-452**  
Metzenbaum  
Operating Scissors,  
Super Cut# 1, B/B,  
Straight, 14cm

**Article#**  
**W17-453**  
Iris Scissors  
Super Cut  
large rings,  
straight, 11.5cm

**Article#**  
**W17-454**  
Iris Scissors T.C  
large rings,  
straight, 11.5cm

**Article#**  
**W17-455**  
Iris Scissors  
large rings,  
straight, 11.5cm

**Article#**  
**W17-456**  
Iris Scissors  
large rings,  
curved, 11.5cm

**Article#**  
**W17-457**  
Iris Scissors  
Super Cut  
large rings,  
curved, 11.5cm

MAXIOFACIAL SECTION 7

Ножницы десневые  
Ciseaux a gencives  
Zahnfleischscheren  
口香糖剪刀

Ножици для ясен  
Tijeras para encias  
مقص صمغ

DENTAL MICRO SURGERY



**Article# W17-458**  
Iris Scissors T.C  
large rings,  
curved, 11.5cm



**Article# W17-459**  
Goldman-Fox  
Scissors,  
Standard  
13cm



serrated  
edge



**Article# W17-460**  
Goldman-Fox  
Scissors,  
Super Cut  
13cm



serrated  
edge



**Article# W17-461**  
Goldman-Fox  
Scissors, T.C  
13cm



**Article# W17-462**  
Goldman-Fox  
Scissors,  
Standard  
Double curved,  
13cm



serrated  
edge



**Article# W17-463**  
Goldman-Fox  
Scissors,  
Super Cut  
Double  
curved, 13cm



serrated  
edge



**Article# W17-464**  
La Grange  
Scissors,  
Standard  
double curved,  
11.5cm



serrated  
edge

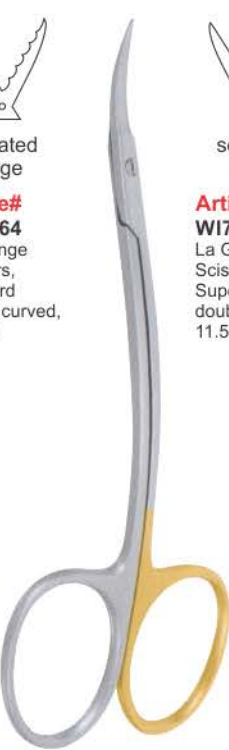

**Article# W17-465**  
La Grange  
Scissors,  
Super Cut  
double curved,  
11.5cm



serrated  
edge



**Article# W17-466**  
Joseph Scissors,  
Standard  
curved, 14cm



serrated  
edge



Str

**Article# W17-467**  
Joseph Scissors,  
Standard  
Straight, 14cm



serrated  
edge



Str



**Article# W17-468**  
Joseph Scissors,  
Super Cut  
curved, 14cm

**Article# W17-469**  
Joseph Scissors,  
Super Cut  
Straight, 14cm

MAXIOFACIAL SECTION 7

- Ножицы десневые
- Ciseaux a gengivas
- Zahnfleischscheren
- 口香糖剪刀
- Ножиці для ясен
- Tijeras para encias
- مقص صمغ

DENTAL MICRO SURGERY



**Article# W17-470**  
Kelly Scissors,  
T.C Super Cut  
Black Titanium  
Coated  
curved, 16cm



**Article# W17-472**  
Dean, Scissors  
T.C Super Cut  
Black Titanium  
Coated  
17cm



**Article# W17-471**  
Kelly Scissors,  
T.C Super Cut  
Black Titanium  
Coated  
Straight, 16cm



**Article# W17-473**  
Metzenbaum Operating  
Scissors, T.C Super Cut  
Black Titanium Coated  
# 1, B/B, curved, 14cm



**Article# W17-474**  
Iris Scissors T.C  
Super Cut  
Black Titanium  
Coated  
large rings,  
straight, 11.5cm



**Article# W17-475**  
Iris Scissors T.C  
Super Cut  
Black Titanium  
Coated  
large rings,  
curved, 11.5cm



**Article# W17-476**  
Goldman-Fox  
Scissors,  
T.C Super Cut Straight  
Black Titanium Coated  
13cm

**Article# W17-477**  
Goldman-Fox Scissors,  
T.C Super Cut Curved  
Black Titanium Coated  
13cm



**Article# W17-478**  
Locklin  
Dissecting  
Scissors,  
S/S  
16cm  
1 Blade  
Serrated



**Article# W17-479**  
Locklin  
Dissecting  
Scissors,  
S/S  
16cm  
1 Blade  
Serrated



**Article# W17-480**  
La Grange  
Scissors,  
Super Cut  
Black Titanium  
Coated  
double  
curved, 11.5cm



**Article# W17-481**  
Joseph Scissors,  
T.C Super Cut  
Black Titanium Coated  
curved, 14cm

**Article# W17-482**  
Joseph Scissors,  
T.C Super Cut  
Black Titanium Coated  
Straight, 14cm

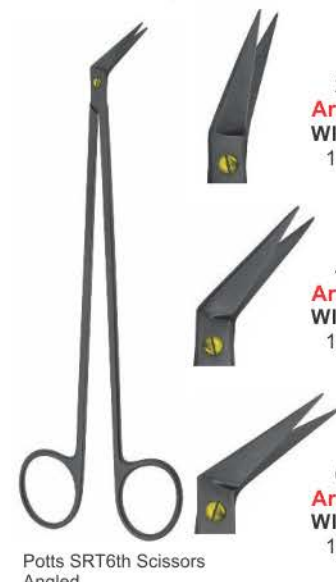

25°  
**Article# W17-483**  
19cm

45°  
**Article# W17-484**  
19cm

60°  
**Article# W17-485**  
19cm

Potts SRT6th Scissors  
Angled

MAXIOFACIAL SECTION 7

Ножницы десневые  
Ciseaux a gencives  
Zahnfleischscheren  
口香糖剪刀

Ножици для ясен  
Tijeras para encias  
مقص صمغ



**Article#**  
WI7-486  
Noyes  
11cm, Straight



**Article#**  
WI7-487  
Noyes  
11cm Curved



**Article#**  
WI7-488  
Noyes  
11cm Angular



**Article#**  
WI7-489  
Westcott Scissors  
11 cm



**Article#**  
WI7-490  
Castroviejo  
15cm Curved



**Article#**  
WI7-491  
Castroviejo RT6cro  
Scissors  
12cm Curved



**Article#**  
WI7-492  
Cephalotomy  
Scissors



**Article#**  
WI7-493  
Vannas Scissors



**Article#**  
WI7-494  
Corneal Scissors  
12.3 cm



**Article#**  
WI7-495  
Iris Scissors



**Article#** WI7-496  
Castroviejo Corneal  
Section Scissors  
Miniature, Slight Curve  
With Stop, 10.8cm



Micro Scissors TC  
Straight  
**Article#**  
WI7-497 14cm  
WI-498 16cm  
WI-499 18cm



Micro Scissors TC  
Curved  
**Article#**  
WI7-500 14cm  
WI-4501 16cm  
WI-4502 18cm



Castroviejo Needle TC  
Straight  
**Article#**  
WI7-503 14cm  
WI-4504 16cm  
WI-4505 18cm



Castroviejo Needle TC  
Curved  
**Article#**  
WI7-506 14cm  
WI-4507 16cm  
WI-4508 18cm



Micro Forceps  
**Article#**  
WI7-509 14cm  
WI7-510 16cm  
WI7-511 18cm



Micro Cooley Forceps  
**Article#**  
WI7-512 14cm  
WI7-513 16cm  
WI7-514 18cm

Set of 3 Pcs



Micro Forceps  
**Article#**  
WI7-515 18cm



Castroviejo Needle TC  
Straight  
**Article#**  
WI7-516 18cm



Micro Scissors TC  
Curved  
**Article#**  
WI7-517 18cm



Micro Cooley Forceps  
**Article#**  
WI7-518 18cm

Set of 3 Pcs



Castroviejo Needle TC  
Straight  
**Article#**  
WI7-519 18cm



Micro Scissors TC  
Curved  
**Article#**  
WI7-520 18cm

DENTAL MICRO SURGERY

MAXIOFACIAL SECTION 7

- Ножницы десневые
- Ножницы для ясен
- Ciseaux a gencives
- Tijeras para encias
- Zahnfleischscheren
- مقص صمغ
- 口香糖剪刀



**Article#**  
**WI7-521**  
Noyes  
11cm, Straight



**Article#**  
**WI7-422**  
Noyes 11cm  
Curved



**Article#**  
**WI7-523**  
Noyes  
11cm Angular



**Article#**  
**WI7-524**  
Westcott Scissors  
11 cm



**Article#**  
**WI7-525**  
Castroviejo  
15cm Curved



**Article#** WI7-426  
Castroviejo Micro  
Scissors  
12cm Curved



**Article#**  
**WI7-527**  
Cepsulotomy  
Scissors



**Article#**  
**WI7-528**  
Vannas Scissors



**Article#**  
**WI7-529**  
Corneal Scissors  
12.3 cm



**Article#**  
**WI7-530**  
Iris Scissors  
12cm



**Article#** WI7-531  
Castroviejo Corneal  
Scissors  
12cm



Micro Scissors TC  
Straight  
**Article#**  
**WI7-532** 14cm  
**WI7-533** 16cm  
**WI7-534** 18cm



Micro Scissors TC  
Curved  
**Article#**  
**WI7-535** 14cm  
**WI7-536** 16cm  
**WI7-537** 18cm



Castroviejo Needle TC  
Straight  
**Article#**  
**WI7-538** 14cm  
**WI7-539** 16cm  
**WI7-540** 18cm



Castroviejo Needle TC  
Curved  
**Article#**  
**WI7-541** 14cm  
**WI7-542** 16cm  
**WI7-543** 18cm



Micro Forceps  
**Article#**  
**WI7-544** 14cm  
**WI7-545** 16cm  
**WI7-546** 18cm



Micro Cooley Forceps  
**Article#**  
**WI7-547** 14cm  
**WI7-548** 16cm  
**WI7-549** 18cm

**Article#** WI7-550 Set of 3 Pcs

**Article#** WI7-554 Set of 3 Pcs



Micro Forceps  
**Article#**  
**WI7-551** 18cm



Castroviejo Needle TC  
Straight  
**Article#** WI7-552 18cm



Micro Scissors TC  
Curved  
**Article#** WI7-553 18cm



Micro Cooley Forceps  
**Article#** WI7-555 18cm



Castroviejo Needle TC  
Straight  
**Article#** WI7-556 18cm



Micro Scissors TC  
Curved  
**Article#** WI7-557 18cm

DENTAL MICRO SURGERY

- Ножницы десневые
- Ciseaux a gencives
- Zahnfleischscheren
- Ножіці для ясен
- Tijeras para encias
- مقص صمغ



**Article# WI7-558**  
Micro Iris  
9 cm  
Straight



**Article# WI7-559**  
Micro Iris  
9 cm  
Curved



**Article# WI7-560**  
Iris  
11.5 cm  
Curved



Iris  
**Article#**  
**WI7-561** 9cm  
**WI7-562** 10.5cm  
**WI7-563** 11.5cm  
**WI7-564** 12cm  
Straight



Iris  
**Article#**  
**WI7-565** 9cm  
**WI7-566** 10.5cm  
**WI7-567** 11.5cm  
**WI7-568** 12cm  
Curved



**Article# WI7-569**  
Angular, Saw edge  
11.5 cm



**Article# WI7-570**  
Angular  
11.5 cm

- Ножницы десневые
- Ciseaux a gencives
- Zahnfleischscheren
- Ножіці для ясен
- Tijeras para encias
- مقص صمغ



**Article# WI7-571**  
Goldman-Fox  
13 cm  
Saw edge,  
straight



**Article# WI7-572**  
Goldman-Fox  
13 cm  
Saw edge,  
curved



**Article# WI7-573**  
Goldman-Fox  
13 cm  
Saw edge,  
double curved



**Article# WI7-574**  
La Grange  
11.5 cm  
Saw edge,  
double curved



**Article# WI7-575**  
Neumann  
12 cm  
Saw edge,  
double curved



**Article# WI7-576**  
Kilner (Ragnell)  
12 cm  
Straight

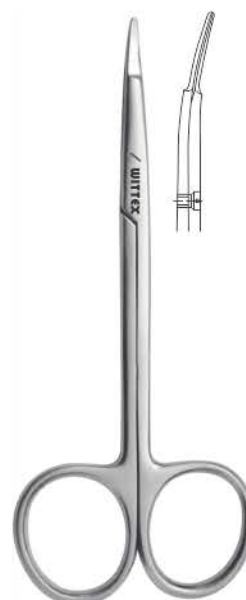

**Article# WI7-577**  
Kilner (Ragnell)  
12 cm  
Curved



**Article# WI7-578**  
Joseph  
14 cm  
Straight

- Ножницы десневые
- Ciseaux a gencives
- Zahnfleischscheren
- Ножіці для ясен
- Tijeras para encias
- مقص صمغ



Joseph  
Article#  
WI7-579 14 cm  
Curved



Kelly  
Article#  
WI7-580 16cm  
WI7-581 18cm  
Straight



Kelly  
Article#  
WI7-582 16cm  
WI7-583 18cm  
Curved



Locklin  
Article#  
WI7-584 16 cm  
Saw edge,  
angular



Locklin  
Article#  
WI7-585 12 cm  
WI7-586 16 cm  
Saw edge,  
angular



DENTAL MICRO SURGERY



Article# WI7-587  
Dean 17 cm  
Saw edge,  
angular



Article# WI7-588  
Straight  
12 cm



Article#  
WI7-589 11.5cm  
WI7-590 13cm  
WI7-591 14cm  
Straight



Article#  
WI7-592 11.5cm  
WI7-593 13cm  
WI7-594 14cm  
Curved



Mayo  
Article#  
WI7-595 14 cm  
WI7-596 16 cm  
WI7-597 18 cm  
Straight  
WI7-598 14 cm  
WI7-599 16 cm  
WI7-600 18 cm  
Curved

- Ножницы десневые
- Ciseaux a gencives
- Zahnfleischscheren
- Ножіці для ясен
- Tijeras para encias
- مقص صغ



**Article#**  
**W17-601**  
Universal  
12 cm  
Saw edge



Beebee  
**Article#**  
**W17-602** 10cm  
**W17-603** 12cm  
Saw edge, straight



Beebee  
**Article#**  
**W17-604** 10cm  
**W17-605** 12cm  
Saw edge, curved



**Article#**  
**W17-606**  
Dental scissors  
large 17.5 cm



**Article#**  
**W17-607** 14cm  
**W17-608** 18cm  
universal  
autoclavable up to  
143 °C

- Ножницы десневые
- Ciseaux a gencives
- Zahnfleischscheren
- Ножиці для ясен
- Tijeras para encias
- مقص صمغ



**Standard Operating Scissors**  
Sharp/Sharp Straight

<b>Article#</b>	
WI7-609	11.5 cm
WI7-610	13.0 cm
WI7-611	14.0 cm
WI7-612	15.0 cm
WI7-613	16.0 cm
WI7-614	17.5 cm
WI7-615	18.5 cm
WI7-616	20.0 cm



**Standard Operating Scissors**  
Sharp/Sharp Curved

<b>Article#</b>	
WI7-617	11.5 cm
WI7-618	13.0 cm
WI7-619	14.0 cm
WI7-620	15.0 cm
WI7-621	16.0 cm
WI7-622	17.5 cm
WI7-623	18.5 cm
WI7-624	20.0 cm



**Standard Operating Scissors**  
Blunt/Blunt Straight

<b>Article#</b>	
WI7-625	11.5 cm
WI7-626	13.0 cm
WI7-627	14.0 cm
WI7-628	15.0 cm
WI7-629	16.0 cm
WI7-630	17.5 cm
WI7-631	18.5 cm
WI7-632	20.0 cm



**Standard Operating Scissors**  
Blunt/Blunt Curved

<b>Article#</b>	
WI7-633	11.5 cm
WI7-634	13.0 cm
WI7-635	14.0 cm
WI7-636	15.0 cm
WI7-637	16.0 cm
WI7-638	17.5 cm
WI7-639	18.5 cm
WI7-640	20.0 cm



**Standard Operating Scissors**  
Sharp/Blunt Straight

<b>Article#</b>	
WI7-641	11.5 cm
WI7-642	13.0 cm
WI7-643	14.0 cm
WI7-644	15.0 cm
WI7-645	16.0 cm
WI7-646	17.5 cm
WI7-647	18.5 cm
WI7-648	20.0 cm



**Standard Operating Scissors**  
Sharp/Blunt Curved

<b>Article#</b>	
WI7-649	11.5 cm
WI7-650	13.0 cm
WI7-651	14.0 cm
WI7-652	15.0 cm
WI7-653	16.0 cm
WI7-654	17.5 cm
WI7-655	18.5 cm
WI7-656	20.0 cm

■ Ножницы десневые    ■ Ножці для ясен  
■ Ciseaux a gencives    ■ Tijeras para encias  
■ Zahnfleischscheren    ■ مقص صمغ



Landolt Operating Scissors



**Article#**  
**WI7-657**  
12.5 cm  
B/B Str.



**Article#**  
**WI7-658**  
12.5 cm  
B/B Cvd.



Deaver Operating,  
Dissecting Scissors



**Article#**  
**WI7-659**  
14.5 cm  
S/B Str.



**Article#**  
**WI7-660**  
14.5 cm  
S/B Cvd.



**Article#**  
**WI7-661**  
14.5 cm  
S/B Str.  
Saw Edge.



**Article#**  
**WI7-662**  
14.5 cm  
S/B Cvd.  
Saw Edge.



Longe Operating  
Dissecting Scissors



**Article#**  
**WI7-663**  
14.5 cm  
S/B Str.



**Article#**  
**WI7-664**  
14.5 cm  
S/B Cvd.



**Article#**  
**WI7-665**  
14.5 cm  
S/B Str.  
Saw Edge.



**Article#**  
**WI7-666**  
14.5 cm  
S/S Cvd.  
Saw Edge.



Incision Operating Scissors



**Article#**  
**WI7-667**  
13 cm  
**WI7-668**  
14.5 cm  
S/S Str.

- Ножницы десневые
- Ciseaux a gencives
- Zahnfleischscheren
- Ножіці для ясен
- Tijeras para encias
- مقص صمغ



Mixer Operating Dissecting Scissors



**Article#**  
WI7-669  
15.5 cm  
B/B Str.



**Article#**  
WI7-670  
15.5 cm  
B/B Cvd.



Lexer Operating Dissecting Scissors



**Article#**  
WI7-671  
16 cm  
WI7-672  
21 cm  
B/B Str.



**Article#**  
WI7-673  
16 cm  
WI7-674  
21 cm  
B/B Cvd.



Jorgenson Operating Dissecting Scissors  
**Article#** WI7-675 22 cm  
B/B, Full Cvd.



Richter Operating Dissecting Scissors  
**Article#** WI7-676 14.5 cm  
Angled



Fergusson Operating Dissecting Scissors  
**Article#**  
WI7-677 14 cm  
WI7-678 16 cm  
WI7-679 18 cm  
B/B, Angled

■ Ножницы десневые ■ Ножці для ясен  
■ Ciseaux a gencives ■ Tijeras para encias  
■ Zahnfleischscheren ■ مقص صمغ

DENTAL MICRO SURGERY



**Wertheim Operating Dissecting Scissors**  
**Article#**  
 WI7-680 14.5 cm  
 WI7-681 22.5 cm  
 B/B, Cvd.



**Metzenbaum Dissecting Scissors**  
**Article#**  
 WI7-682 20 cm  
 WI7-683 23 cm  
 WI7-684 28 cm  
 B/B, Cvd.



**Metzenbaum-Jamison Scissors**  
**Article#** WI7-685 15 cm  
 S/S, Str.



**Article#**  
 WI7-686  
 15 cm  
 B/B Str.

**Article#**  
 WI7-687  
 15 cm  
 B/B Cvd.



**Mayo Dissecting Scissors**



**Article#**  
 WI7-688  
 14.5 cm  
 WI7-689  
 15 cm  
 WI7-690  
 17 cm  
 WI7-691  
 23 cm  
 B/B, Str.



**Article#**  
 WI7-692  
 14.5 cm  
 WI7-693  
 15 cm  
 WI7-694  
 17 cm  
 WI7-695  
 23 cm  
 B/B, Cvd.



**Mayo-Stillé Dissecting Scissors**



**Article#**  
 WI7-696  
 15 cm  
 WI7-697  
 17 cm  
 WI7-698  
 19.5 cm  
 WI7-699  
 21 cm  
 B/B, Str.



**Article#**  
 WI7-700  
 15 cm  
 WI7-701  
 17 cm  
 WI7-702  
 19.5 cm  
 WI7-703  
 21 cm  
 B/B, Cvd.

**MAXIOFACIAL  
SECTION 7**

- Ножницы десневые
- Ciseaux a gencives
- Zahnfleischscheren
- Ножиці для ясен
- Tijeras para encias
- مقص صمغ

DENTAL MICRO SURGERY



**Article#**  
**WI7-704**  
22 cm  
B/B, Str.

**Article#**  
**WI7-705**  
22 cm  
B/B, Cvd.



**Article#**  
**WI7-706**  
17 cm  
B/B, Str.

**Article#**  
**WI7-707**  
17 cm  
B/B, Cvd.



**Article#**  
**WI7-708** 14.5 cm  
**WI7-709** 18 cm  
**WI7-710** 20 cm  
**WI7-711** 23 cm  
**WI7-712** 25 cm  
**WI7-713** 28 cm  
B/B Str.



**Article#**  
**WI7-714** 14.5 cm  
**WI7-715** 18 cm  
**WI7-716** 20 cm  
**WI7-717** 23 cm  
**WI7-718** 25 cm  
**WI7-719** 28 cm  
B/B Cvd.

**Mayo-Harrington Dissecting Scissors**

**Mayo-Noble Dissecting Scissors**

**Metzbaum Operating Dissecting Scissors Blunt/Blunt Str.**



**Metzbaum-Nelson Scissors**



**Article#**  
**WI7-720** 18 cm  
**WI7-721** 20 cm  
**WI7-722** 23 cm  
**WI7-723** 25 cm  
**WI7-724** 28 cm  
**WI7-725** 30 cm  
B/B Str.



**Article#**  
**WI7-726** 18 cm  
**WI7-727** 20 cm  
**WI7-728** 23 cm  
**WI7-729** 25 cm  
**WI7-730** 28 cm  
**WI7-731** 30 cm  
S/B Str.



**Article#**  
**WI7-732** 18 cm  
**WI7-733** 20 cm  
**WI7-734** 23 cm  
**WI7-735** 25 cm  
**WI7-736** 28 cm  
**WI7-737** 30 cm  
S/S Str.



**Metzbaum-Nelson Scissors**



**Article#**  
**WI7-738** 18 cm  
**WI7-739** 20 cm  
**WI7-740** 23 cm  
**WI7-741** 25 cm  
**WI7-742** 28 cm  
**WI7-743** 30 cm  
B/B Cvd.



**Article#**  
**WI7-744** 18 cm  
**WI7-745** 20 cm  
**WI7-746** 23 cm  
**WI7-747** 25 cm  
**WI7-748** 28 cm  
**WI7-749** 30 cm  
S/B Cvd.



**Article#**  
**WI7-750** 18 cm  
**WI7-751** 20 cm  
**WI7-752** 23 cm  
**WI7-753** 25 cm  
**WI7-754** 28 cm  
**WI7-755** 30 cm  
S/S Cvd.

MAXIOFACIAL SECTION 7

- Ножницы десневые
- Ciseaux a gencives
- Zahnfleischscheren
- Ножці для ясен
- Tijeras para encias
- مقص صمغ



Metzenbaum-Fino Scissors



**Article#**  
W17-756  
14.5 cm  
B/B Str.



**Article#**  
W17-757  
14.5 cm  
S/S Str.



**Article#**  
W17-758  
14.5 cm  
B/B Cvd.



**Article#**  
W17-759  
14.5 cm  
S/S Cvd.

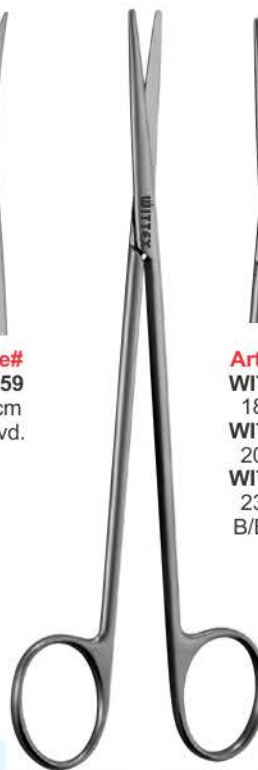

Metzenbaum-Fino Scissors



**Article#**  
W17-760  
18 cm  
W17-761  
20 cm  
W17-762  
23 cm  
B/B Str.



**Article#**  
W17-763  
18 cm  
W17-764  
20 cm  
W17-765  
23 cm  
B/B Cvd.



**Article#**  
W17-766  
18 cm  
W17-767  
20 cm  
W17-768  
23 cm  
B/B Slightly  
Cvd.

DENTAL MICRO SURGERY



Kaye Face Lift Scissors

**Article#**  
W17-769 11.5cm  
W17-770 14 cm  
W17-771 15 cm  
W17-772 18 cm  
W17-773 20 cm  
B/B, Str.

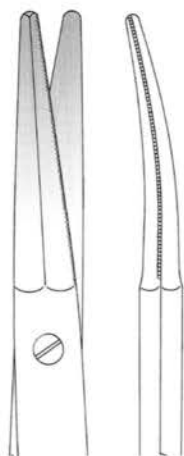

Kaye Face Lift Scissors

**Article#**  
W17-774 11.5 cm  
W17-775 14 cm  
W17-776 15 cm  
W17-777 18 cm  
W17-778 20 cm  
B/B, Cvd.



Gorney Face Lift Scissors

**Article#**  
W17-779 18 cm  
W17-780 18 cm serrated  
W17-781 23 cm serrated  
B/B, Str.

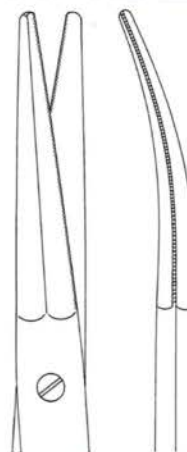

**Article#**  
W17-782 18 cm  
W17-783 23 cm  
B/B, Cvd, Serrated

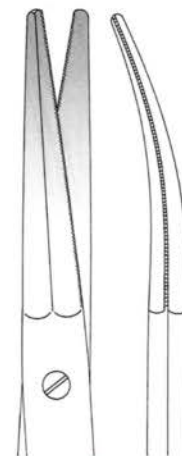

**Article#**  
W17-784 18 cm  
B/B, Cvd.

- Ножницы десневые
- Ciseaux a gencives
- Zahnfleischscheren
- Ножіці для ясен
- Tijeras para encias
- مقص صمغ



Rees Face Lift Scissors  
Article# WI7-786 17 cm  
B/B, Str.

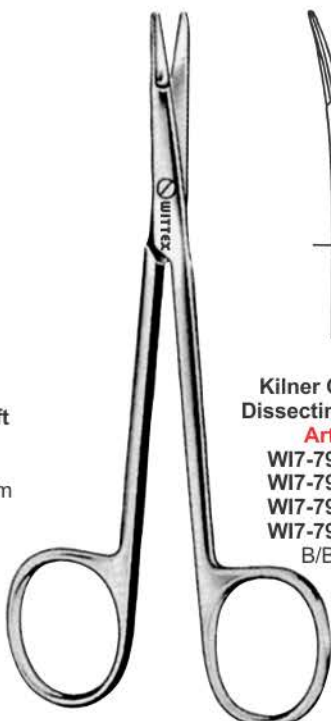

Kilner Operating Dissecting Scissors  
Article# WI7-791 12 cm  
WI7-792 15 cm  
WI7-793 18 cm  
WI7-794 20 cm  
B/B Cvd.

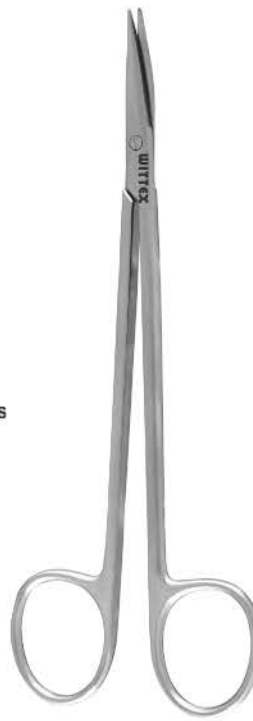

Reynolds Operating, Dissecting Scissors  
Article# WI7-795 15 cm  
WI7-796 18 cm  
S/S Str.



Reynolds Operating, Dissecting Scissors  
Article# WI7-797 15 cm  
WI7-798 18 cm  
S/S Cvd.



Sanvenero Operating Dissecting Scissors



Article# WI7-799 14 cm  
S/S Str.



Article# WI7-800 14 cm  
S/S Cvd.



Dubois Dissecting & Gynecological Scissors  
Article# WI7-801 27 cm  
B/B Str.



Dubois Dissecting & Gynecological Scissors  
Article# WI7-802 27 cm  
B/B Cvd.



Neumann Vascular Scissors  
Article# WI7-803 12.5 cm  
S/S Double Cvd.

- Ножницы десневые
- Ciseaux a gencives
- Zahnfleischscheren
- Ножіці для ясен
- Tijeras para encias
- مقص صمغ



**Killner Tendon Scissors**  
**Article# WI7-804** 11.5 cm  
 Straight, B/B



**Littler Tendon Scissors**

**Article#**  
**WI7-805** 11.5 cm  
**WI7-806** 14 cm  
 Cvd, S/S



**Strabismus Tendon Scissors**

**Article#**  
**WI7-807** 11.5 cm  
 Str, B/B  
**WI7-808** 11.5 cm  
 Cvd, B/B



**Potts-Reynolds Tenotomy Scissors**  
**Article# WI7-809** 12 cm  
 S/S Cvd.



**Wagner Gum Scissors**  
 Plastic surgery

**Article#**  
**WI7-810**  
 12 cm  
 S/S Str.

**Article#**  
**WI7-811**  
 12 cm  
 S/S Cvd.



**Brophy (sullivan) Scissors**

**Article#**  
**WI7-812**  
 14.5 cm  
 S/S Str.

**Article#**  
**WI7-813**  
 14.5 cm  
 S/S Cvd.



**Potts Tenotomy Scissors**

**Article#**  
**WI7-814** 15 cm  
**WI7-815** 17 cm  
**WI7-816** 20 cm  
 S/S



**Wilmer Iris Scissors**  
**Article# WI7-817** 9 cm  
 S/S Angled

- Ножницы десневые
- Ciseaux a gencives
- Zahnfleischscheren
- Ножіці для ясен
- Tijeras para encias
- مقص صمغ



Potts-Smith Vascular Scissors S/S Angled

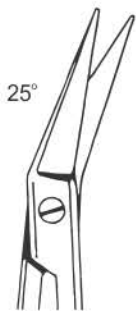

Article# WI7-818  
19 cm



Article# WI7-819  
19 cm



Article# WI7-820  
19 cm

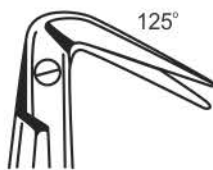

Article# WI7-821  
19 cm



Potts-Smith Scissors Article# WI7-822 19.5 cm B/B Angled.



Cardiovascular Scissors Article# WI7-823 12 cm Probe End



Enterotomy Scissors Article# WI7-824 21 cm



Enterotomy Scissors Article# WI7-825 21 cm



Enterotomy Scissors Article# WI7-826 21 cm



Spencer Stitch Scissors Article# WI7-827 9 cm  
WI7-828 11 cm  
WI7-829 14 cm Str.

- Ножницы десневые
- Ciseaux a gencives
- Zahnfleischscheren
- Ножіці для ясен
- Tijeras para encias
- مقص صمغ



**Cottle Scissors**  
Article# W17-830 16 cm  
B/B, Angled



**Fomon Scissors**  
Article# W17-831 14.5 cm  
B/B, Angled



**Sailer Scissors**  
Article# W17-832 17 cm  
B/B, Angled



**Harvey Scissors**  
Article# W17-833 12.5 cm  
Saw Edge

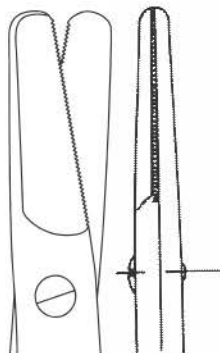

**Schoemaker-Loth Scissors**  
Article# W17-834 12.5 cm



**Eiselsberg Scissors**  
Article# W17-835 11 cm

■ Ножницы десневые ■ Ножиці для ясен  
■ Ciseaux a gencives ■ Tijeras para encias  
■ Zahnfleischscheren ■ مقص صمغ



Bruns Scissors

**Article#**  
**WI7-836**  
 24 cm  
 Cvd, Probe End



**Article#**  
**WI7-837**  
 24 cm  
 Cvd, Serrat  
 Probe End



**Lister Bandage  
 Plaster Scissors**  
**Article#**  
**WI7-838** 9cm  
**WI7-839** 11 cm  
**WI7-840** 14 cm  
**WI7-841** 16 cm  
**WI7-842** 18 cm  
**WI7-843** 20 cm  
**WI7-844** 24 cm



**Burnham Bandage  
 Plaster Scissors**  
**Article# WI7-845**  
 14 cm Angled



**Braun-Stadler Plaster  
 Scissors**  
**Article#**  
**WI7-846** 14 cm  
**WI7-847** 20 cm  
 B/B, Angled



**Busch Plaster Scissors**  
**Article#**  
**WI7-848** 13 cm  
**WI7-849** 16 cm  
 B/B, Cvd.



**Modified-USA Plaster Scissors**  
**Article# WI7-850** 10 cm



**Seutin Plaster Scissors**  
**Article# WI7-851** 20 cm  
 Probe End



**Seutin Plaster Scissors**  
**Article# WI7-852** 23 cm  
 Probe End



Operating Scissors, S/S Str. T/C Insert

<b>Article#</b>	
WI7-853	11.5 cm
WI7-854	13 cm
WI7-855	14 cm
WI7-856	15 cm
WI7-857	16 cm
WI7-858	17.5 cm
WI7-859	18.5 cm
WI7-860	20 cm



Operating Scissors, S/S Cvd. T/C Insert

<b>Article#</b>	
WI7-861	11.5 cm
WI7-862	13 cm
WI7-863	14 cm
WI7-864	15 cm
WI7-865	16 cm
WI7-866	17.5 cm
WI7-867	18.5 cm
WI7-868	20 cm



Operating Scissors, B/B Str. T/C Insert

<b>Article#</b>	
WI7-869	11.5 cm
WI7-870	13 cm
WI7-871	14 cm
WI7-872	15 cm
WI7-873	16 cm
WI7-874	17.5 cm
WI7-875	18.5 cm
WI7-876	20 cm



Operating Scissors, B/B Cvd. T/C Insert

<b>Article#</b>	
WI7-877	11.5 cm
WI7-878	13 cm
WI7-879	14 cm
WI7-880	15 cm
WI7-881	16 cm
WI7-882	17.5 cm
WI7-883	18.5 cm
WI7-884	20 cm



Operating Scissors, S/B Standard Str. T/C Insert

<b>Article#</b>	
WI7-885	11.5 cm
WI7-886	13 cm
WI7-887	14 cm
WI7-888	15 cm
WI7-889	16 cm
WI7-890	17.5 cm
WI7-891	18.5 cm
WI7-892	20 cm



Operating Scissors, S/B Standard Cvd. T/C Insert

<b>Article#</b>	
WI7-893	11.5 cm
WI7-894	13 cm
WI7-895	14 cm
WI7-896	15 cm
WI7-897	16 cm
WI7-898	17.5 cm
WI7-899	18.5 cm
WI7-900	20 cm

**MAXIOFACIAL  
SECTION 7**

■ Ножницы десневые  
■ Ciseaux a gencives  
■ Zahnfleischscheren

■ Ножиці для ясен  
■ Tijeras para encias  
■ مقص صمغ

DENTAL MICRO SURGERY



**Metzenbaum Operating  
Scissors T/C Insert**



**Article#**  
**WI7-901**  
11.5 cm  
**WI7-902**  
14.5 cm  
B/B Str.



**Article#**  
**WI7-903**  
11.5 cm  
**WI7-904**  
14.5 cm  
S/B Str.



**Article#**  
**WI7-905**  
11.5 cm  
**WI7-906**  
14.5 cm  
S/S Str.



**Article#**  
**WI7-907**  
11.5 cm  
**WI7-908**  
14.5 cm  
B/B Cvd.



**Article#**  
**WI7-909**  
11.5 cm  
**WI7-910**  
14.5 cm  
S/B Cvd.



**Article#**  
**WI7-911**  
11.5 cm  
**WI7-912**  
14.5 cm  
S/S Cvd.



**Metzenbaum Operating  
Scissors T/C Insert**



**Metzenbaum-Nelson  
Operating Scissors  
T/C Insert**



**Article#**  
**WI7-913**  
18 cm  
**WI7-914**  
20 cm  
**WI7-915**  
23 cm  
**WI7-916**  
25 cm  
**WI7-917**  
28 cm  
**WI7-918**  
30 cm  
B/B Str.



**Article#**  
**WI7-919**  
18 cm  
**WI7-920**  
20 cm  
**WI7-921**  
23 cm  
**WI7-922**  
25 cm  
**WI7-923**  
28 cm  
**WI7-924**  
30 cm  
S/B Str.



**Article#**  
**WI7-925**  
18 cm  
**WI7-926**  
20 cm  
**WI7-927**  
23 cm  
**WI7-928**  
25 cm  
**WI7-929**  
28 cm  
**WI7-930**  
30 cm  
S/S Str.



**Article#**  
**WI7-931**  
18 cm  
**WI7-932**  
20 cm  
**WI7-933**  
23 cm  
**WI7-934**  
25 cm  
**WI7-935**  
28 cm  
**WI7-936**  
30 cm  
B/B Cvd.



**Article#**  
**WI7-937**  
18 cm  
**WI7-938**  
20 cm  
**WI7-939**  
23 cm  
**WI7-940**  
25 cm  
**WI7-941**  
28 cm  
**WI7-942**  
30 cm  
S/B Cvd.



**Article#**  
**WI7-943**  
18 cm  
**WI7-944**  
20 cm  
**WI7-945**  
23 cm  
**WI7-946**  
25 cm  
**WI7-947**  
28 cm  
**WI7-948**  
30 cm  
S/S Cvd.



**Metzenbaum-Nelson  
Operating Scissors  
T/C Insert**

■ Ножницы десневые ■ Ножиці для ясен  
■ Ciseaux a gencives ■ Tijeras para encias  
■ Zahnfleischscheren ■ مقص صمغ



**Article#**  
**WI7-949** 14.5 cm  
**WI7-950** 18 cm  
**WI7-951** 20 cm  
**WI7-952** 23 cm  
 B/B Str.



**Article#**  
**WI7-953** 14.5 cm  
**WI7-954** 18 cm  
**WI7-955** 20 cm  
**WI7-956** 23 cm  
 B/B Cvd.



**Article#**  
**WI7-957** 14.5 cm  
**WI7-958** 18 cm  
**WI7-959** 20 cm  
**WI7-960** 23 cm  
 S/S Str.



**Article#**  
**WI7-961** 14.5 cm  
**WI7-962** 18 cm  
**WI7-963** 20 cm  
**WI7-964** 23 cm  
 S/S Cvd.



Metzenbaum-Fino Operating Scissors T/C Insert

Metzenbaum-Fino Operating Scissors T/C Insert



**Article#**  
**WI7-965** 14.5 cm  
**WI7-966** 15 cm  
**WI7-967** 17 cm  
**WI7-968** 23 cm  
 B/B, Str.



**Article#**  
**WI7-969** 14.5 cm  
**WI7-970** 15 cm  
**WI7-971** 17 cm  
**WI7-972** 23 cm  
 B/B, Cvd.



**Article#**  
**WI7-973** 15 cm  
**WI7-974** 17 cm  
**WI7-975** 19.5 cm  
**WI7-976** 21 cm  
 B/B, Str.



**Article#**  
**WI7-977** 15 cm  
**WI7-978** 17 cm  
**WI7-979** 19.5 cm  
**WI7-980** 21 cm  
 B/B, Cvd.



Mayo Dissecting & Gynecological Scissors T/C Insert

Mayo-stille Dissecting & Gynecological Scissors T/C Insert

- Ножницы десневые
- Ciseaux a gencives
- Zahnfleischscheren
- Ножіці для ясен
- Tijeras para encias
- مقص صمغ

T.C GOLD



**Article#**  
WI7-981  
Iris  
11cm  
Straight



**Article#**  
WI7-982  
Iris  
11cm  
Curved



**Article#**  
WI7-983  
Goldman-Fox  
13cm  
Saw edge, straight



**Article#**  
WI7-984  
Goldman-Fox  
13cm  
Saw edge, Curved



**Article#**  
WI7-985  
Iris Double Bend  
11cm



**Article#**  
WI7-986  
La Grange  
11.5cm  
Saw edge,  
double Curved



**Article#**  
WI7-987  
Dean Scissors TC  
17cm curve



**Article#**  
WI7-988  
Kelly  
16cm  
Straight



**Article#**  
WI7-989  
Kelly  
16cm  
Curved

- Ножницы десневые
- Ciseaux a gencives
- Zahnfleischscheren
- Ножіці для ясен
- Tijeras para encias
- مقص صمغ



Goldmann-Fox Operating Scissors T/C Insert



Article# WI7-990  
13 cm  
S/S Str.



Article# WI7-991  
13 cm  
S/S Cvd.

T.C GOLD



Lister Bandage Plaster Scissors T/C Insert one large ring

- Article#
- WI7-992 14 cm
  - WI7-993 16 cm
  - WI7-994 18 cm
  - WI7-995 20 cm



Lister Bandage Plaster Scissors, T/C Insert

- Article#
- WI7-996 9 cm
  - WI7-997 11.5 cm
  - WI7-998 14 cm
  - WI7-999 16 cm
  - WI7-1000 18 cm
  - WI7-1001 20 cm



Article# WI7-1002  
Universal  
12 cm



Article# WI7-1003  
Beebee  
11 cm  
Saw edge, straight



Article# WI7-1004  
Beebee  
11 cm  
Saw edge, curved



Article# WI7-1005  
Beebee  
12 cm  
Saw edge, straight



Article# WI7-1006  
Beebee  
12 cm  
Saw edge, curved

- Ножницы десневые
- Ciseaux a gencives
- Zahnfleischscheren
- Ножіці для ясен
- Tijeras para encias
- مقص صمغ

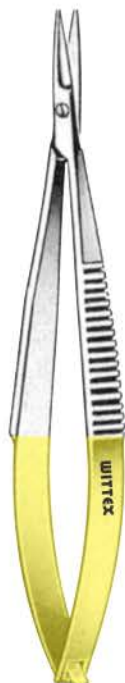

**Article#**  
**WI7-1007**  
14 cm  
B/B Str.

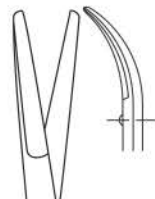

**Article#**  
**WI7-1008**  
14 cm  
B/B Cvd.



**Article#**  
**WI7-1009**  
14 cm  
S/B Str.

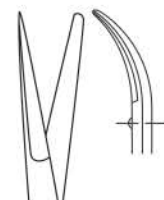

**Article#**  
**WI7-1010**  
14 cm  
S/B Cvd.



**Article#**  
**WI7-1011**  
14 cm  
S/S Str.

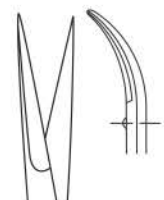

**Article#**  
**WI7-1012**  
14 cm  
S/S Cvd.



**Article#**  
**WI7-1013**  
14 cm  
S/S Str.



**Article#**  
**WI7-1014**  
14 cm  
S/S Cvd.

Castroviejo Scissors  
T/C Insert

Joseph Operating  
Scissors T/C Insert



**Article#**  
**WI7-1015**  
16 cm  
**WI7-1016**  
18 cm  
S/S Str.



**Article#**  
**WI7-1017**  
16 cm  
**WI7-1018**  
18 cm  
S/S Cvd.



Foman Operating  
Scissors T/C Insert  
**Article#** WI7-1019  
13 cm Full Bent



**Article#**  
**WI7-1020**  
10 cm  
**WI7-1021**  
11 cm  
Str.



**Article#**  
**WI7-1022**  
10 cm  
**WI7-1023**  
11 cm  
Cvd.

Reynolds Operating  
Scissors T/C Insert

Stevens Operating  
Scissors T/C Insert

- Костные кусачки
- Кусачки для кісток
- Hohlmeißelzangen
- Pinzas-gubias
- Pincès-gouges
- روتجیورس العظام



**Article# WI7-1024**  
Surgical Bone Rongeur - Friedman  
14.5cm



**Article# WI7-1025**  
Surgical Bone Rongeur - Mini Friedman  
15° 12cm



**Article# WI7-1026**  
Surgical Bone Rongeur - Micro Friedman  
15° 14.5cm



**Article# WI7-1027**  
Surgical Bone Rongeur - Micro Friedman  
90° 14.5cm



**Article# WI7-1028**  
Surgical Bone Rongeur - Micro Friedman  
45° 14.5cm



**Article# WI7-1029**  
Ruskin Mini, Rongeurs  
Curved, 15cm,  
5mm diameter tip



**Article# WI7-1030**  
Boehler, Rongeurs  
double action hinged, curved,  
15cm, 2mm diameter tip



**Article# WI7-1031**  
Beyer, Rongeurs  
double action hinged,  
18cm, 3mm diameter tip



Kerrison  
15 cm

**Article# WI7-1032**  
2 mm

**Article# WI7-1033**  
3 mm

**Article# WI7-1034**  
5 mm



**Article# WI7-1035**  
Tomati  
12cm

MAXIOFACIAL SECTION 7

Костные кусачки  
Hohlmeißelzangen  
Pincès-gouges

Кусачки для кісток  
Pinzas-gubias  
رونجبورس العظام

Шприцы стоматологические карпульные  
Seringues à usage dentaire  
Dentalspritzen  
牙科注射器

Шприці стоматологічні карпульні  
Jeringas dentales  
المحافن الأسنان

DENTAL MICRO SURGERY



**Article#**  
**W17-1036**  
Surgical Bone Rongeur - Friedman 14.5cm



**Article#**  
**W17-1037**  
Surgical Bone Rongeur - Mini Friedman 15° 12cm



**Article#**  
**W17-1038**  
Surgical Bone Rongeur - Micro Friedman 30° 14.5cm



**Article#**  
**W17-1039**  
Surgical Bone Rongeur - Micro Friedman 45° 14.5cm



**Article#**  
**W17-1040**  
Surgical Bone Rongeur - Micro Friedman 90° 14.5cm



**Article#**  
**W17-1041**  
Ruskin Mini, Rongeurs Curved, 15cm, 5mm diameter tip



**Article#**  
**W17-1042**  
Boehler, Rongeurs double action hinged, curved, 15cm, 2mm diameter tip



**Article#**  
**W17-1043**  
Beyer, Rongeurs double action hinged, 18cm, 3mm diameter tip



Behind Every Smile is a Story

ORTHODONTIC PLIERS

- QUALITY - ЯКІСТЬ
- PRECISION - ТОЧНІСТЬ
- ACCURACY - ПРАВИЛЬНІСТЬ
- DURABILITY - ЗНОСОСТІЙКІСТЬ



● Super-sharp diamond-boned cutters  
● smooth ultra-polished and contoured edges  
● brilliant corrosion resistant stainless steel finish

● superior T-12 stainless steel tool inserts  
● sliding lock joint for balance & precision alignment

● Super-sharp diamond-boned cutters  
● smooth ultra-polished and contoured edges  
● brilliant corrosion resistant stainless steel finish

● superior T-12 stainless steel tool inserts  
● sliding lock joint for balance & precision alignment

**STYLE A**

**STYLE B**

ORTHODONTIC PLIERS SECTION 8

ORTHODONTIC PLIERS

orthodontics pliers in Clinical Dentistry Orthodontics and Dentofacial Orthopaedics

Driven by the demand for tooth alignment, general practitioners are increasingly being asked to provide orthodontic treatment.

Dentists keen to participate in this area of expertise need to demonstrate the skills to identify suitable patients, the ability to provide conventional and contemporary orthodontic treatment and be aware of its limitations.

This is exactly what this programme delivers, along with the vital core competencies to excel in this unique postgraduate area.

The objective of the Orthodontics and Dentofacial Orthopaedics is to provide dental surgeons with the core knowledge and clinical skills essential for the delivery of competent, high-quality dental care.

It encompasses a blended learning approach and consists of a combination of lectures, seminars, workshops, clinical case discussions and laboratory sessions.

The flexible modular structure enables the programme to meet a wide range of student needs.

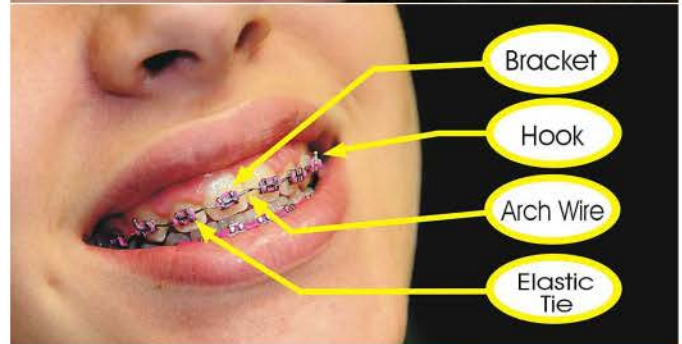

**ORTHODONTIC PLIERS  
SECTION 8**

Инструменты ортодонтические  
Instrumentos Ortodonticos  
Orthodontische Instrumente

Инструменти ортодонтични  
Instruments Orthodontiques  
ادوات تقويم الأسنان



**Article# WI8-001**  
Height Gauge 0.18  
Aluminum



**Article# WI8-002**  
Height Gauge 0.22  
Aluminum



**Article# WI8-003**  
Height Gauge 0.18  
Stainless Steel



**Article# WI8-004**  
Height Gauge 0.22  
Stainless Steel



**Article# WI8-005**  
Moveable  
Height Gauge



**Article# WI8-006**  
Bone Bracket Gauge



**Article# WI8-007**  
Endo Finger  
Ruler Span  
Measure Scale



**Article# WI8-008**  
Endo Finger  
Ruler Span  
Measure Scale



**Article# WI8-009**  
Endo Finger  
Ruler Span  
Measure Scale



**Article# WI8-010**  
Endo Finger Ruler  
Span Measure Scale



**Article# WI8-011**  
Endo Finger Ruler  
Span Measure Scale

ORTHODONTIC PLIERS

Инструменты ортодонтические  
Instrumentos Ortodonticos  
Orthodontische Instrumente

Инструменти ортодонтични  
Instruments Orthodontiques  
ادوات تقويم الأسنان



**Article# W18-012**  
Bone Thickness Gauge  
40mm, 18cm



**Article# W18-013**  
Osteometer  
Measuring Forceps For Jaw  
Ridge Width measurement, scale  
on both sides, rustfree, autoclavic



**Article# W18-014**  
Positive  
Postioner



**Article# W18-015**  
Strip Saw



**Article# W18-016**  
Compasso  
De Willis

ORTHODONTIC PLIERS



**Article# W18-017**  
Band seater  
auto cleavable  
Triangle Shape



**Article# W18-018**  
Band seater  
auto cleavable  
Square Shape



**Article# W18-019**  
Band seater  
auto cleavable  
Round Shape



**Article# W18-020**  
Mershon Band  
Pusher  
14cm

**Article# W18-021**  
Wamkey Set of 3 Pcs Including Drill



**Article# W18-022**

**Article# W18-023**

**Article# W18-024**

Инструменты ортодонтические  
Instrumentos Ortodonticos  
Orthodontische Instrumente

Инструменти ортодонтични  
Instruments Orthodontiques  
ادوات تقويم الأسنان

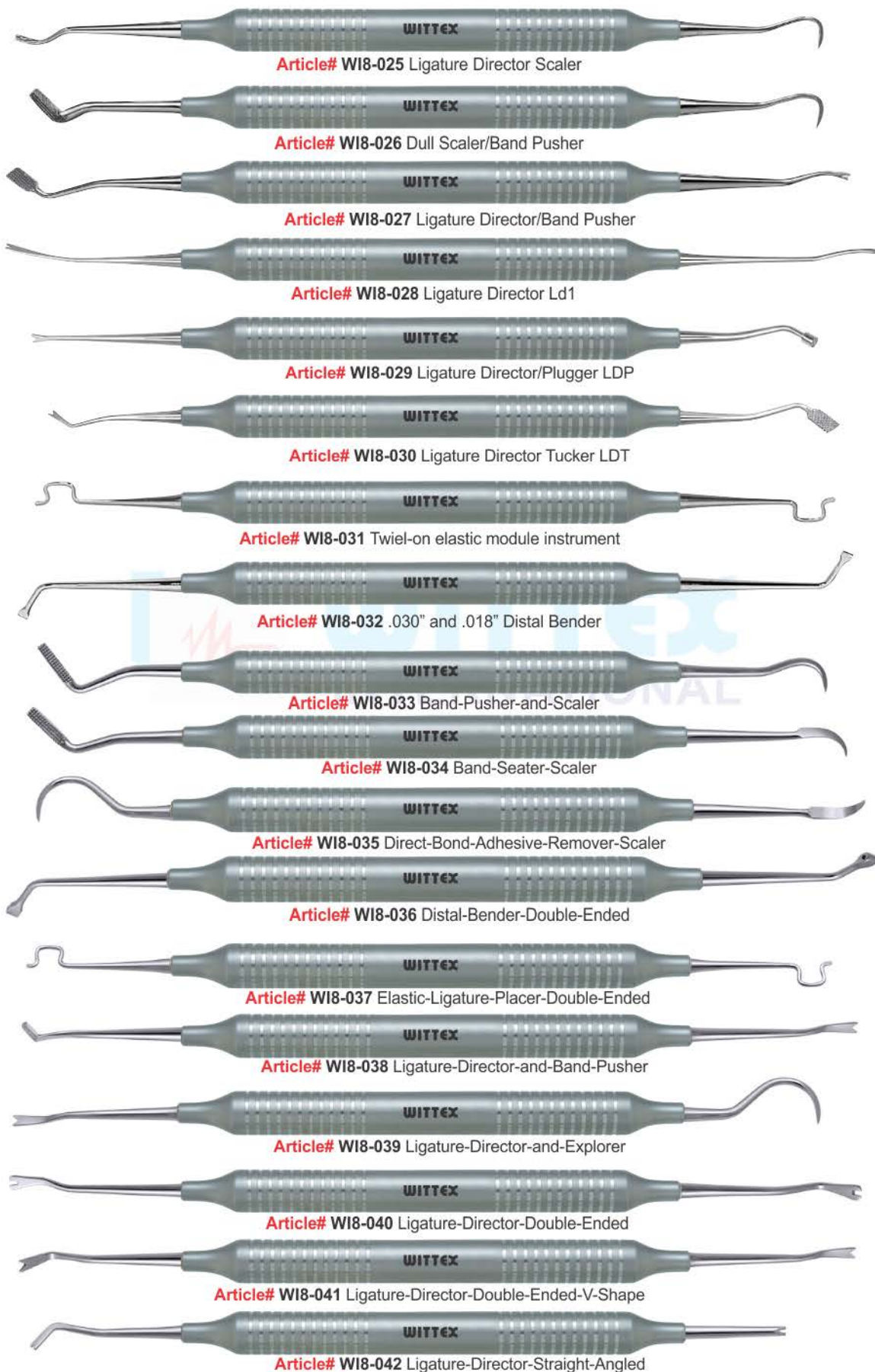

Инструменты ортодонтические  
Instrumentos Ortodonticos  
Orthodontische Instrumente

Инструменти ортодонтични  
Instruments Orthodontiques  
ادوات تقويم الأسنان

**Bracket Holder Tweezers**



**Article#**  
**WI8-043**  
Deluxe Bracket  
Holder Tweezers



**Article#**  
**WI8-044**  
Deluxe Bracket  
Holder Tweezers



**Article#**  
**WI8-045**  
Direct Bond Bracket  
Holder Tweezers



**Article#**  
**WI8-046**  
Bracket Tweezers  
Slot Aligner



**Article#** WI8-047  
Direct Bond  
Bracket Holder  
Tweezers, Small Tip



**Article#**  
**WI8-048**  
Exact Bracket  
Holder Tweezers



**Article#**  
**WI8-049**  
Bracket Placing  
Tweezers



**Article#**  
**WI8-050**  
Easy Access  
Tweezers



**Article#**  
**WI8-051**  
Bracket Placer  
Tweezers  
(Extra Fine Tip)



**Article#**  
**WI8-052**  
Deluxe Bracket  
Holder Tweezers  
13.5cm



**Article#**  
**WI8-053**  
Easy Eccess  
Tweezers



**Article#**  
**WI8-054**  
Slipper  
Tweezers



**Article#**  
**WI8-055**  
Direct Bonding  
Bracket Holders  
13.5cm



**Article#**  
**WI8-056**  
Direct Bonding  
Bracket Holders  
13.6cm



**Article#**  
**WI8-057**  
Direct Bonding  
Bracket Holders  
13.5cm



**Article#**  
**WI8-058**  
Deluxe Bracket  
Holder



**Article#**  
**WI8-059**  
Direct Bonding  
Bracket Holders  
14cm

ORTHODONTIC UTILITY PLIERS



**Article# W18-060**

**How Plier**  
 Universally usable tool for the multiband technology for wires up to .028".  
 Length 14.5cm



**Article# W18-061**

**How Plier curved**  
 Universally usable tool for the multiband technology for wires up to .028".  
 Length 14.5cm



**Article# W18-062**

**Weingart Plier medium**  
 Weingart plier that are ideal due to their curved tip for setting sheets and is capable of bending the ends.  
 Length 14.5cm



**Article# W18-063**  
**Crown & Shell Plier**  
 13cm



**Article# W18-064**  
**Contouring Plier**  
 Fig. 2  
 13.5cm



**Article# W18-065**  
**Johnson Contouring Pliers**  
 14cm



**Article# W18-066**

**Band Removing Plier**  
 The curved blade of the band removing plier can strip easily and gently remove directly to the tooth. Length 14cm



**Article# W18-067**

**Bracket Removing Plier**  
 Bracket removing plier for comfortable and quick removal of the brackets.  
 Length 13.5cm



**Article# W18-068**

**Bracket Removing Plier curved**  
 Bracket Removing Plier curved for easy removal of brackets in the posterior region. Length 14.5cm

Щипцы для ортодонтии и протезирования    Щипці для ортодонтії та протезування  
 Pincettes pour l'orthodontie et la prothèse    Alicates para ortodoncia y prótesis  
 Zangen für Kieferorthopädie und Prothetik    كمامشة لتقويم الأسنان بروتستیس

ORTHODONTIC UTILITY PLIERS



**Article# W18-069**  
 Angle Plier  
 Fig. 2  
 14cm



**Article# W18-070**  
 Angle Plier  
 Fig. 4  
 14cm



**Article# W18-071**  
 Tweed / angle rectangular  
 arch forming & Torquing pliers  
 13.5cm



**Article# W18-072**  
 Bird Beak With Cutter  
 and 2 Grooves



**Article# W18-073**  
 Adams Plier  
 Adams pliers for bending wire  
 arches and bends right angles  
 for wires up to .022", .025 tip  
 to beak. Length 13cm



**Article# W18-074**  
 Angle Plier  
 Fig. 1  
 13.5cm



**Article# W18-075**  
 Angle Plier  
 Fig. 3  
 13cm



**Article# W18-076**  
 Tweed Loop Plier  
 13cm



**Article# W18-077**  
 Jarabak Plier  
 14.5cm



**Article# W18-078**  
 Tweed Loop  
 forming Pliers  
 14cm

WIRE BENDING/FORMING PLIERS

VERTICAL LOOP / STEP BEND PLIER



**Article# W18-079**  
Nance Loop forming  
Pliers 14cm

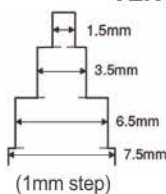

**Article# W18-080**

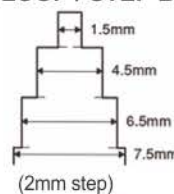

**Article# W18-081**

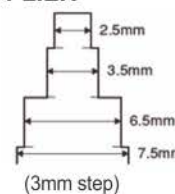

**Article# W18-082**

ORTHODONTIC PLIERS



**Article# W18-083**  
Young Wire Bending &  
Loop Forming Pliers  
13.5cm



**Article# W18-084**  
Schwarz  
13cm



**Article# W18-085**  
Universal Dolphin Style  
Wire Bending & cutting pliers



**Article# W18-086**  
De La Rosa  
Fig. 1  
13.5cm



**Article# W18-087**  
Arch Counting Plier Grooved  
for double back and triple back  
bands in 0.30" / 0.76mm & 0.36"  
/ 0.91mm lingual arch wires  
13.5cm



**Article# W18-088**  
Aderer Plier  
For the manufacturing of appliances and  
activation of wires for wires up to .030" .fine  
tip and up to .036" mean tip.  
Length 13cm

■ Щипцы для ортодонтии и протезирования    ■ Щипці для ортодонтії та протезування  
■ Pincettes pour l'orthodontie et la prothèse    ■ Alicates para ortodoncia y prótesis  
■ Zangen für Kieferorthopädie und Prothetik    ■ كمامشة لتقويم الأسنان بروتستيتيس

**WIRE BENDING/FORMING PLIERS**



**Article# W18-089**  
Nance Pliers  
13.5cm



**Article# W18-090**  
Aderer  
Large wire bending  
and loop forming pliers  
13cm



**Article# W18-091**  
Falcon Beak  
Contouring Pliers.  
13cm



**Article# W18-092**  
Grooved Fine Plier  
14.5cm



**Article# W18-093**  
Aderer  
Facebow loop forming Pliers  
14.5cm



**Article# W18-094**  
V Bending Pliers  
13.5cm



**Article# W18-095**  
Wald sachs Wire Bending  
and Cutting Pliers  
15cm



**Article# W18-096**  
Universal Plier  
16.5cm



**Article# W18-097**  
Flat Nose Pliers  
14cm

WIRE BENDING/FORMING PLIERS

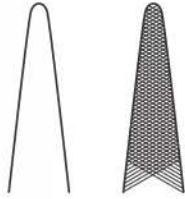

**Article# W18-099**  
 Flat Nose Pliers  
 both sides serrated  
 14cm



**Article# W18-100**  
 Peeso  
 Wire Bending Pliers  
 13.5cm

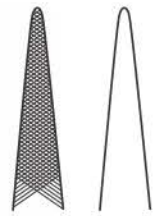

**Article# W18-101**  
 Goslee  
 Flat Nose Pliers  
 14cm

**Article# W18-098**  
 Flat Nose Pliers  
 both sides smooth  
 14cm



ORTHODONTIC PLIERS



**Article# W18-102**  
 Flat Nose Pliers  
 both sides serrated  
 with TC 14cm inserts



**Article# W18-103**  
 Ball Hook Crimping Plier  
 Designed for surgical ball hooks and auxiliaries, the slotted tip holds auxiliaries secure to allow for tight crimping.



**Article# W18-104**  
 Cinch Back Plier  
 This plier easily cinches the wire behind the buccal tube with one squeeze after wire is ligated into place. Slim line design allows for maximum patient comfort.

- Щипцы для ортодонтии и протезирования
- Щипці для ортодонтії та протезування
- Pinces pour l'orthodontie et la prothèse
- Alicates para ortodoncia y prótesis
- Zangen für Kieferorthopädie und Prothetik
- كماشة لتقويم الأسنان بروسثيتيس



**Article# WI8-105**  
Standard Pin & Ligature  
Cutter Straight

This standard cutter is designed to cut soft wire pins and ligature wire.  
MAXIMUM CUTTING CAPACITY:  
Soft wire up to .015" (.38mm)



**Article# WI8-106**  
Standard Pin & Ligature  
Cutter Angle 15°

This standard cutter is designed to cut soft wire pins and ligature wire.  
MAXIMUM CUTTING CAPACITY:  
Soft wire up to .015" (.38mm)



**Article# WI8-107**  
Micro Ligature Cutter  
Straight

The fine small narrow tips allow easy access to the most difficult to reach areas. The inserted tips ensure precision cutting of elastics, soft wire pins and soft ligature wire.  
MAXIMUM CUTTING CAPACITY:  
Soft wire up to .015" (.38mm)



**Article# WI8-108**  
Micro Ligature Cutter  
Angle 15°

The fine small narrow tips allow easy access to the most difficult to reach areas. The inserted tips ensure precision cutting of elastics, soft wire pins and soft ligature wire.  
MAXIMUM CUTTING CAPACITY:  
Soft wire up to .015" (.38mm)



**Article# WI8-109**  
Pin & Ligature Cutter  
Long Handle

This standard cutter is designed to cut soft wire pins and ligature wire.  
MAXIMUM CUTTING CAPACITY:  
Soft wire up to .015" (.38mm)



**Article# WI8-110**  
Hard Wire Cutter  
Straight

Easily cuts any size pin or archwires. The inserted tips ensure perfect tip alignment and precision cutting.  
MAXIMUM CUTTING CAPACITY:  
Archwires up to 0.21" x 0.25"  
(.55 X .64mm)



**Article# WI8-111**  
Hard Wire Cutter  
Angle 15°

Easily cuts any size pin or archwires. The inserted tips ensure perfect tip alignment and precision cutting. The advantage of 15° angle for easier access to the posterior area.  
MAXIMUM CUTTING CAPACITY:  
Archwires up to 0.21" x 0.25"  
(.55 X .64mm)



**Article# WI8-112**  
Mini Ligature cutters T.C  
fine tip  
13cm

**DISTAL END CUTTER**



**Article# WI8-113**

**Distal End Cutter Safety Hold**

This instrument cuts the wire close to buccal tube and safely holds the distal end. The Tungsten Carbide inserts ensure precision cutting, long wear and unsurpassed cutting performance. Maximum Cutting Capacity: archwires up to .021" X .025" (.55 X .64mm)



**Article# WI8-114**

**Distal End Cutter Safety Hold- Mini**

This instrument cuts the wire close to buccal tube and safely holds the distal end. The Tungsten Carbide inserts ensure precision cutting, long wear and unsurpassed cutting performance. Maximum Cutting Capacity: archwires up to .021" X .025" (.55 X .64mm)



**Article# WI8-115**

**Distal End Cutter Safety Hold- Long Handle**

This instrument cuts the wire close to buccal tube and safely holds the distal end. The Tungsten Carbide inserts ensure precision cutting, long wear and unsurpassed cutting performance. Maximum Cutting Capacity: archwires up to .021" X .025" (.55 X .64mm)

ORTHODONTIC PLIERS



**Article# WI8-116**

**Distal End Cutter Safety Hold - Flush Cut**

The flush cut feature of this instrument allows the archwire to be flush cut with the end of buccal tube, eliminating the possibility of patient discomfort resulting from archwire position. Maximum Cutting Capacity: archwires up to .021" X .025" (.55 X .64mm)

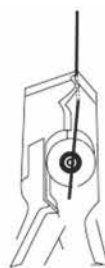

**Article# WI8-117**

**Small**

Fluch-cut distal and cutting Pliers T.C with safety hold fitted with un-breakable, corrosion resistant and durable stainless steel tips 13cm



**Article# WI8-118**

**Large**

Fluch-cut distal and cutting Pliers T.C with safety hold fitted with un-breakable, corrosion resistant and durable stainless steel tips 13cm

■ Щипцы для ортодонтии и протезирования    ■ Щипці для ортодонтії та протезування  
■ Pincettes pour l'orthodontie et la prothèse    ■ Alicates para ortodoncia y prótesis  
■ Zangen für Kieferorthopädie und Prothetik    ■ كمامشة لتقويم الأسنان بروسیتیس



**Article# W18-119**  
Jarabak Pliers



**Article# W18-120**  
Light Wire Pliers With Groove



**Article# W18-121**  
Lingual Arch Forming Pliers



**Article# W18-122**  
Ligatuer Bending plier



**Article# W18-123**  
Bird Beak Pliers



**Article# W18-124**  
Bracket Removing Plier  
Angled Tc - Inserts



**Article# W18-125**  
Dental Orthodontic Pliers  
Crimpable Hook Placement



**Article# W18-126**  
Crimpable Hook  
Placement



**Article# W18-127**  
Rectangular Arch  
Forming Pliers



**Article# W18-128**  
NiTi Three Jaw Pliers



**Article# W18-129**  
Hammerhea  
NiTi Distal Cinch Back Pliers



**Article# W18-130**  
Direct angled band plier anterior  
posterior bracket removing plier



**Article# W18-131**  
Hard wire cutters



**Article# W18-132**  
Heavy Wire Cutter



**Article# W18-133**  
Extra Heavy Wire Cutter

Щипцы для ортодонтии и протезирования  
 Pincettes pour l'orthodontie et la prothèse  
 Zangen für Kieferorthopädie und Prothetik

Щипці для ортодонції та протезування  
 Alicates para ortodoncia y prótesis  
 كمامشة لتقويم الأسنان بروتستيس

THERMO PLIERS & MATHIEU NEEDLE HOLDERS



**Article# W18-134**  
**Hole Punch Plier**  
 Creates half-moon cutouts in clear aligners to allow space for bonded buttons used for elastics



**Article# W18-135**  
**Vertical Punch Plier**  
 This versatile plier emphasizes on over-correction of rotations by creating an indentation at the mesial or distal line angles on the facial and/or lingual of a specific tooth. Can also be used to create a rotational couple using vertical indents on facial and lingual surfaces on opposite sides of a tooth.



**Article# W18-136**  
**Tear Drop Punch Plier**  
 Designed to create a notch at the gingival margin of clear aligners anywhere elastic hooks are required within the arch, making sure the elastic stays in place once the aligner is seated.



**Article# W18-137**  
**Horizontal Punch Plier**  
 Designed to produce an indentation to accent individual root torque. Can also be used to enhance retention of clear aligner or retainers by placing an indent into a tooth's undercut or below a bonded attachment.



**Article# W18-138**  
**Dimple Punch Plier**  
 Creates a tiny rounded dimple for spot contacts to accent individual tooth movements or added aligner retention. Typically used to accent movement on any tooth that requires a slight "nudge"



**Article# W18-139**  
**Eraser Plier**  
 The eraser plier is designed to remove and flatten any unwanted indentations placed on clear aligners by other punch pliers.



**Article# W18-140**  
**Groove thermal forming plier**  
 Designed for making grooves on clear appliances, to hold the elastic, prevent it falling off



**Article# W18-141**  
**Thermoplier Micro-Ramp Pliers**  
 Tip, torque or rotate smaller teeth laterally; Allow contact close to incisal edge On the correct location on the target tooth



**Article# W18-142** Pink  
**Thermoplier Small Circle Pliers**  
 Increase the size (depth) of small existing force point Location of the existing force point



**Article# W18-143**  
**Crown Beebe Scissors**  
 4.5 Str.



**Article# W18-144**  
**Mathieu Standard Tip**



**Article# W18-145**  
**Elastomeric ligature placing forceps with groove**  
 14cm



**Article# W18-146**  
**Mathieu Narrow Tip**



**Article# W18-147**  
**Mathieu Smaha Ultra fine tip**



**Article# W18-148**  
**Mathieu Standard Tip Tungsten Carbide**



**Article# W18-149**  
**Mathieu Narrow Tip Tungsten Carbide**



**Article# W18-150** Str.  
**Article# W18-151** Cvd.  
**Smaha Elastomeric ligature placing forceps**  
 140 mm

- Щипцы для ортодонтии и протезирования
- Щипці для ортодонтії та протезування
- Pincettes pour l'orthodontie et la prothèse
- Alicates para ortodoncia y prótesis
- Zangen für Kieferorthopädie und Prothetik
- كمامشة لتقويم الأسنان بروتستيتيس



**Article# W18-152**  
Separating Pliers  
For Separators  
15.5cm



**Article# W18-153**  
Elastic  
Separating Plier



**Article# W18-154**  
Methieu Plier  
With Ring



**Article# W18-155**  
Pliers to Place  
Modules 14cm



**Article# W18-156**  
Elastomeric Ligature  
Placing Forceps  
with groove 140 mm



**Article# W18-157**  
Elastomeric Ligature  
Placing Forceps T.C  
with groove 140 mm



**Article# W18-158**  
Mathieu  
14cm



**Article# W18-159**  
Mathieu Ligature Pliers  
14cm



**Article# W18-160**  
Ligature Pliers  
T.C Gold  
With Tungsten  
Carbide  
Inserts 14cm



**Article# W18-161 Str. W18-162 Cvd.**  
Smaha Elastomeric  
ligature placing  
forceps 140 mm



**Article# W18-163**  
Elastomeric ligature  
placing forceps  
with groove  
14cm



**Article# W18-164**  
Forceps For Placing  
Dental astics 12cm

- Ортодонтия Щипцы Подставки
- Supports de pinces d'orthodontie
- Kieferorthopädie Zangenständer
- Ортодонтия Щипці Підставки
- KFO Zangen Ständer
- تقويم الأسنان كماشة تقف



**Article# W18-165**  
Plier Stand  
Stainless Steel.



**Article# W18-166**  
Plier Stand  
Stainless Steel.



**Article# W18-167**  
Pliers Stand  
Stainless Rod  
(Aluminum Anodized)  
Stainless Steel



**Article# W18-168**  
Plier Stand  
Stainless Steel.



**Article# W18-169**  
Plier Stand  
Stainless Steel.



**Article# W18-170**  
Plier Stand  
Plastic



**Article# W18-171**

Generic 1Pc Dental Orthodontic Arch  
Forming Turret 0 Degree Without Torque  
available color

Щипцы для ортодонтии и протезирования  
Pincettes pour l'orthodontie et la prothèse  
Zangen für Kieferorthopädie und Prothetik

Щипці для ортодонції та протезування  
Alicates para ortodoncia y prótesis  
كماشة لتقويم الأسنان بروتستيس



**Article# W18-172**

Orthodontic Set of 21 Pcs

- 01 Plier 02 Plier
- 03 Plier 04 Plier
- 05 Plier 06 Plier
- 07 Plier 08 Plier
- 09 Plier 10 Plier
- 11 Plier 12 Clamp
- 13 Plier 14 Mathieu Needle Holder
- 15 Elevator
- 16 Gauge 17 Tweezer
- 18 Band Seater
- 19 Tweezer 20 Scaler 21 Scaler

**Article# W18-173**

Orthodontic Set of 18 Pcs

- 01 Mirror With Handle
- 02 Plier 03 Scissor
- 04 Plier 05 Tweezer
- 06 Plier 07 Matrix Retainer
- 08 Band Seater
- 09 Plier 10 Tweezer
- 11 Plier 12 Probe
- 13 Plier 14 Plier
- 15 Plier 16 Needle Holder
- 17 Plier 18 Plier

ORTHODONTIC PLIERS



**Article# W18-174**

Orthodontic Set of 10 Pcs

- 01 Plier
- 02 Plier
- 03 Scaler
- 04 Scaler
- 05 Mathieu Needle Holder
- 06 Plier
- 07 Plier
- 08 Tweezer
- 09 Band Seater
- 10 Plier



**Article#  
W18-175  
Set**



## DENTAL IMPLANT INSTRUMENTS FUNCTION

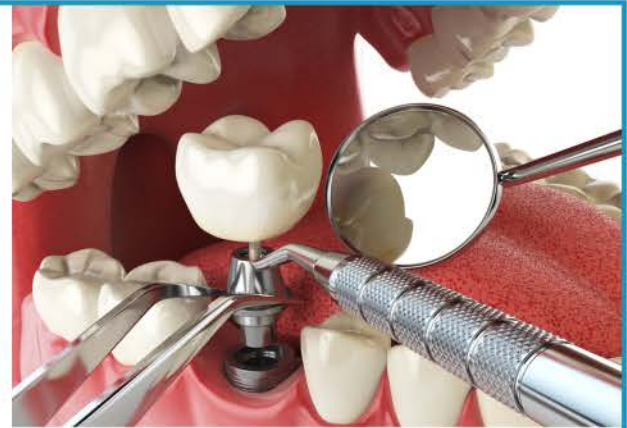

**Instruments for dental implants are made of high quality stainless steel.**

**Our line of instruments include, but is not limited to, the following products:**

#### **Bone Grafting Instruments**

- Bone Curettes (SPRATT) – designed for harvesting bone
- Bone Grinder – used in conjunction with a mallet to grind bone into appropriate particle sizes
- Bone Basin – weighted bottom design prevents tipping or spilling while mixing bone or other bone grafting materials
  - Bone Compactors – feature serrated tips for compacting bone
  - Scalpels & Biopsy Punches
- Scalpels – offers convenience of a disposable with razor sharp cutting edge for superior cutting
- Biopsy Punches – designed at a steeper angle to ensure a finely honed, sharper edge
- Bone Spreading Chisels
- Freer Chisels – double or single cut tips used for widening ridges during implant preparations
- Graduated Chisels – feature reference markings for measurement during a bone ridge augmentation and are available in straight and curved patterns

#### **Osteotomes**

- Concave Osteotomes – break the floor of the maxillary sinus through the implant cavity and are available in curved (off set) and straight (with or without stops)
- Convex Osteotomes – raise the floor of the maxillary sinus and are available in curved (off set) and straight patterns (with or without stops)
- Progressive Osteotomes – designed to prepare the implant site in the maxillary area where bone density is 3 or 4
- Bone Spreading Osteotomes – sharp or blunt configurations for progressive circumferential expansion of the implant site

#### **Sinus Lift Instruments**

- Sinus Lift Curettes and Elevators – lightweight, wide diameter stainless steel hand instruments lift the sinus membrane for bone augmentation procedures

#### **Gauges & Calipers**

- Gauges & Calipers – various measuring devices available to determine appropriate length, width, and distance for implant procedures

#### **Collagen Products**

- Collagen wound dressing product offering includes products.

#### **Sterilization Trays**

- Sterilization Trays – designed to protect and store instruments during sterilization, transportation and storage

IMPLANT GAGES



**Article# W19-001**  
Multifunctional Meter  
Length 9cm  
different sizes,  
8-10-11mm,  
corrosion-resistant

**Article# W19-002**  
Multifunctional Meter  
Length 9cm  
different sizes,  
5-13-15-17 mm,  
corrosion-resistant

**Article# W19-003**  
Measuring Probe  
Length 17cm  
(6-8-10-14-16 mm),  
corrosion-resistant

**Article# W19-004**  
Implant  
Depth Gauge

**Article# W19-005**  
Implant  
Depth Gauge  
& Key

**Article# W19-006**  
Implant  
Depth Gauge

**Article# W19-007**  
Implant  
Depth Gauge

IMPLANT GAGES



**Article# W19-008**  
Double Ended Osteotomy Depth Gauge

**Article# W19-009**  
Double Ended Osteotomy Depth Gauge

**Article# W19-010**  
Double Ended Osteotomy Depth Gauge

**Article# W19-011**  
Depth & Gingival Gauges

Caliper / Calipers Rule



**Article# WI9-012**  
 Castroviejo Calipers  
 20mm, 45°  
 9cm



**Article# WI9-013**  
 Castroviejo Calipers  
 20mm  
 9cm



**Article# WI9-014**  
 Castroviejo Calipers  
 20mm  
 9cm



DENTAL IMPLANT



**Article# WI9-015**  
 Ridge Mapping  
 Double Caliper



**Article# WI9-016**  
 Fig. 5  
 Castroviejo  
 18cm



**Article# WI9-017**  
 Fig. 4  
 Castroviejo  
 18cm



**Article# WI9-018**  
 Fig. 3  
 Castroviejo  
 18cm



**Article# W19-019**  
Clamp, Osteometer  
Length about 15.5cm,  
ridge width measurement,  
two-sided scale,  
measuring  
range 0 - 25 mm



**Article# W19-020**  
Measuring Loop  
straight length 9cm,  
measuring range  
0 - 40 mm



**Article# W19-021**  
Measuring Loop  
angled, length 9cm,  
measuring range  
0 - 40 mm



**Article# W19-022**  
Measuring loop, Castroviejo  
angled, length 17.5cm,  
measuring range 0 - 40 mm,  
with window



**Article# W19-023**  
Measuring Loop  
angled, length  
17.5cm,  
measuring range  
0 - 40 mm



**Article# W19-024**  
Measuring Loop  
straight length  
17.5cm,  
measuring range  
0 - 40 mm



**Article# W19-025**  
Fig. 1  
Iwanson  
spring caliper  
For metal and  
porcelain.



**Article# W19-026**  
Fig. 2  
Iwanson  
spring caliper  
For wax.



**Article# W19-027**  
Bone Thickness Gauge  
40mm,  
18cm

Инструменты для имплантологии  
 Implantologie  
 Implantologie

Инструменти для імплантології  
 Implantologia  
 زراعة الأسنان



Article# WI9-028  
 Boley Gauge



Article# WI9-029  
 Vernier Gauge

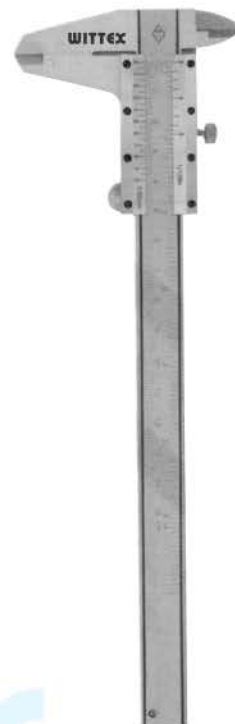

Article# WI9-030  
 Alluminium Caliper  
 up to 20cm



Article# WI9-031  
 Boley Gauge

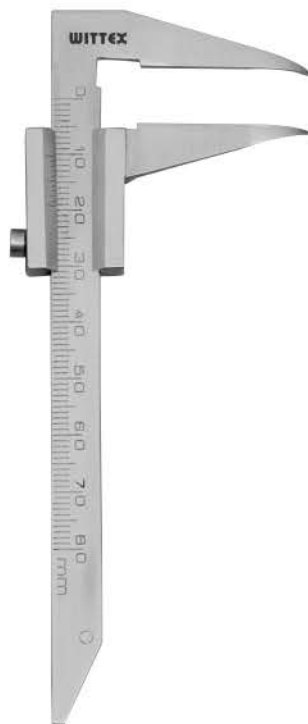

Article# WI9-032  
 Delux Boley  
 Gauge

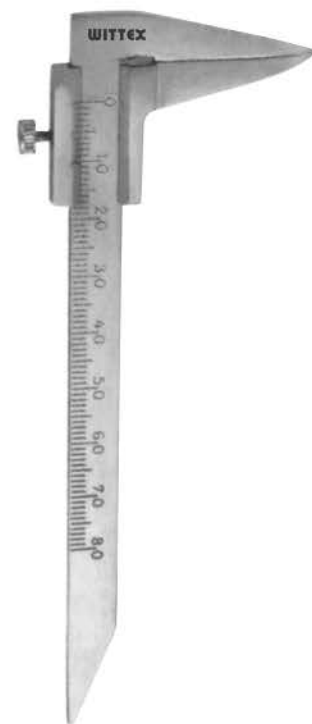

Article# WI9-033  
 Beerendonk  
 13cm  
 Mini Gauge

Инструменты для имплантологии  
 Implantologie  
 Implantologie

Инструменти для імплантології  
 Implantologia  
 زراعة الأسنان

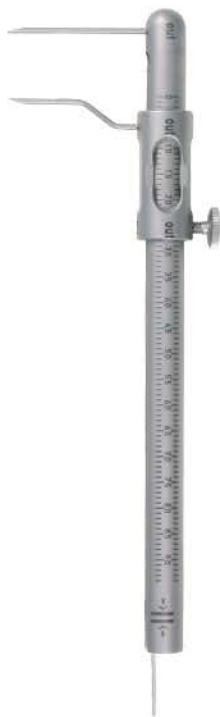

Article# WI9-034  
 Micro Boley Gauge Twisted



Article# WI9-035  
 Micro Boley Gauge Straight



Article# WI9-036  
 Dentaurum Ruler



Article# WI9-037  
 Ruler Wedge



Article# WI9-038  
 Ruler



Article# WI9-039  
 Ortho Ruler / Cone Socket



Article# WI9-040  
 Dynamometer

Инструменты для имплантологии  
 Implantologie  
 Implantologie

Инструменти для імплантології  
 Implantologia  
 زراعة الأسنان

**FLEXIBLE PERITOME SET**



Article# WI9-041  
Peritome

FP Fig. 9



Article# WI9-042  
Peritome

FP Fig. 4



Article# WI9-043  
Peritome

FP Fig. 3



Article# WI9-044  
Peritome

FP Fig. 2



Article# WI9-045  
Peritome

FP Fig. 1



Article# WI9-046  
Pt2 Titanium A/V Regular



Article# WI9-047  
Peritome



Article# WI9-048  
Peritome



Article# WI9-049  
Peritome

Flexible Peritome small kit



Article# WI9-050  
Flexible Peritome Set of 4 Pcs



■ Инструменты для имплантологии    ■ Инструменти для имплантології  
■ Implantologie    ■ Implantologia  
■ Implantologie    ■ زراعة الأسنان

**Periotome Flexible Kit with Titanium set of 6 Pcs**

Article# WI9-051

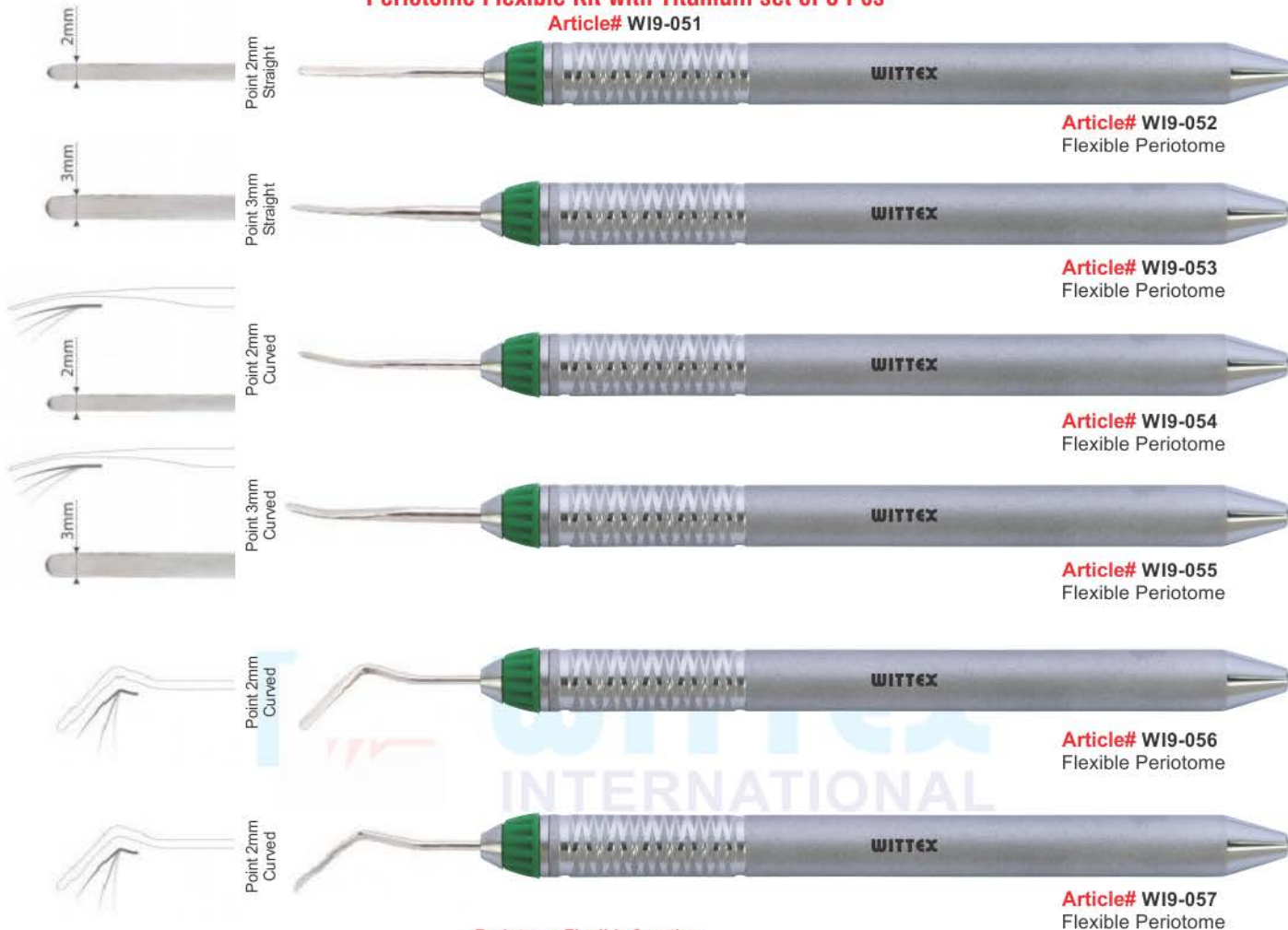

Article# WI9-052  
Flexible Periotome

Article# WI9-053  
Flexible Periotome

Article# WI9-054  
Flexible Periotome

Article# WI9-055  
Flexible Periotome

Article# WI9-056  
Flexible Periotome

Article# WI9-057  
Flexible Periotome

**Periotome Flexible function**

Micro-serrated for simple and Efficient separation of the periodontal ligament. Coated with titanium for greater hardness and longer service life.

The new, flexible periotomes by Ofer a new dimension to the function and safety of severing the periodontal ligament in preparation for extraction. Made of flexibly resilient stainless steel, serrated, and engineered with varying positions of "stress relief," two distinct sets of periotomes are offered. The MSP-1F and MSP-2F have ranges of motion of 6+ degrees, and the MSP-1XXF and MSP-2XXF have ranges of motion of 10+ degrees. Both sets are highly resistant to spontaneous fracture and provide different features and benefits. The MSP-1F and MSP-2F provide the stiffness needed in situations that require strength, while the MSP-1XXF and MSP-2XXF provide the flexibility necessary to follow root surface curvatures during operation and even help to locate the most efficient path of insertion.



Article# WI9-058

Article# WI9-059

Article# WI9-060

Article# WI9-061

Article# WI9-062

Article# WI9-063  
Soft Brushing Kit  
Set of 6 Pcs

- Инструменты для имплантологии
- Implantologie
- Implantologie
- 种植牙学
- Инструменти для імплантології
- Implantoloia
- زراعة الأسنان

DENTAL IMPLANT

CONVEXES



2,7 Ømm, 3,2 Ømm, 3,7 Ømm, 4,2 Ømm, 5 Ømm

**Article# W19-064**  
SET OF 5 PIECES  
Convexes

CONVEXES



2,7 Ømm, 3,2 Ømm, 3,7 Ømm, 4,2 Ømm, 5 Ømm

**Article# W19-070**  
SET OF 5 PIECES  
Convexes Curved

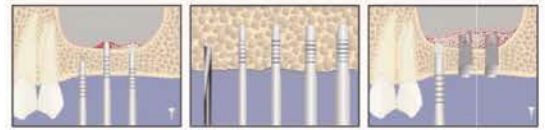

**Article# W19-067**  
Osteotome Convexes  
Straight Curved  
SET OF 11 PIECES

CONCAVES



2,7 Ømm, 3,2 Ømm, 3,7 Ømm, 4,2 Ømm, 5 Ømm

**Article# W19-065**  
SET OF 5 PIECES  
Concaves

CONCAVES



2,7 Ømm, 3,2 Ømm, 3,7 Ømm, 4,2 Ømm, 5 Ømm

**Article# W19-071**  
SET OF 5 PIECES  
Concaves Curved

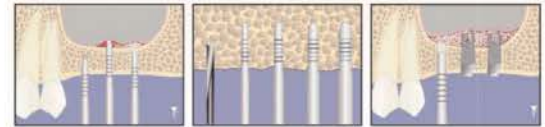

**Article# W19-068**  
Osteotome Concaves  
Straight Curved  
SET OF 11 PIECES

CONIQUES

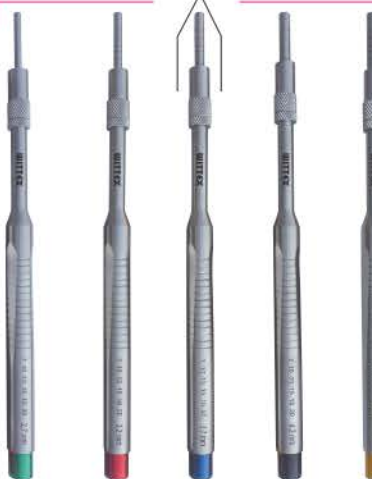

2,7 Ømm, 3,2 Ømm, 3,7 Ømm, 4,2 Ømm, 5 Ømm

**Article# W19-066**  
SET OF 5 PIECES  
Coniques

CONIQUES



2,7 Ømm, 3,2 Ømm, 3,7 Ømm, 4,2 Ømm, 5 Ømm

**Article# W19-072**  
SET OF 5 PIECES  
Coniques Curved

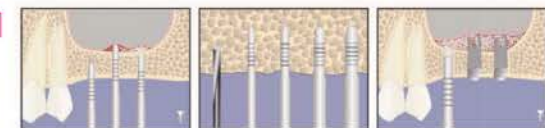

**Article# W19-069**  
Osteotome Coniques  
Straight Curved  
SET OF 11 PIECES

BONE INJECTORS, COLLECTORS & SUCTION TUBE

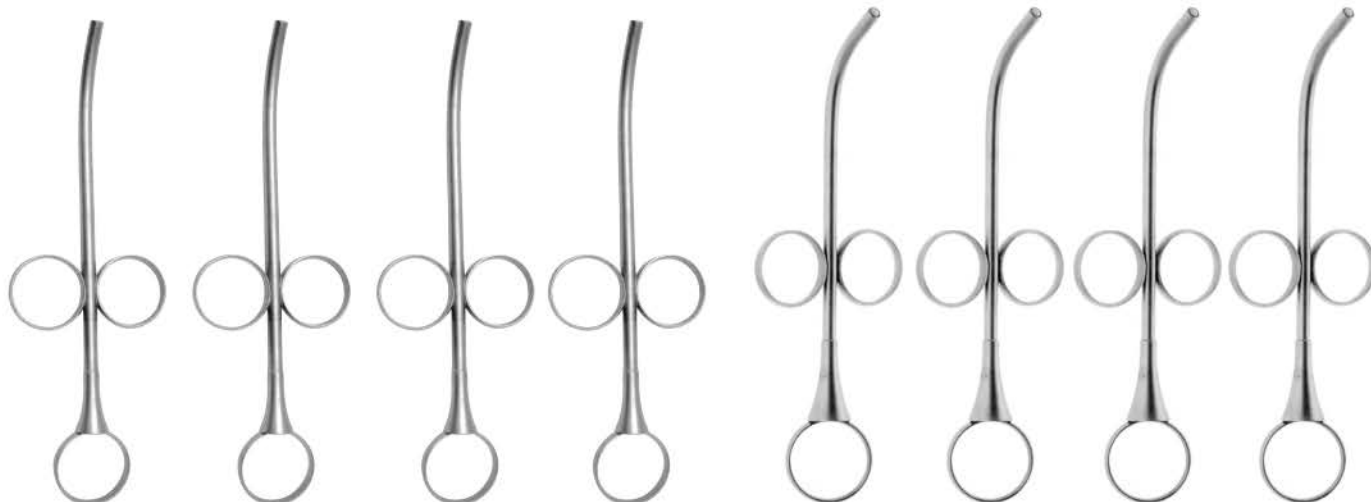

**Article#**  
W19-073  
Ø 2,5mm  
Straight / Bend  
18cm  
I.D 2.5mm  
O.D 3.5

**Article#**  
W19-074  
Ø 3,5mm  
Straight / Bend  
18cm  
I.D 3.5mm  
O.D 4.5

**Article#**  
W19-075  
Ø 4,5mm  
Straight / Bend  
18cm  
I.D 4.5mm  
O.D 5.5

**Article#**  
W19-076  
Ø 6,0mm  
Straight / Bend  
18cm  
I.D 6.0mm  
O.D 7.0

**Article#**  
W19-077  
Ø 2,5mm  
17cm  
I.D 2.5mm  
O.D 3.5

**Article#**  
W19-078  
Ø 3,5mm  
17cm  
I.D 3.5mm  
O.D 4.5

**Article#**  
W19-079  
Ø 4,5mm  
17cm  
I.D 4.5mm  
O.D 5.5

**Article#**  
W19-080  
Ø 6,0mm  
17cm  
I.D 6.0mm  
O.D 7.0

DENTAL IMPLANT



**Article#** W19-081  
Amalgam Gun



**Article#** W19-082  
Suction Cannula Kit  
with 3 Needles



Suction Pipe



Suction Needle  
1mm



Suction Needle  
1.5mm



Suction Needle  
2mm

IMPLANTOLOGY SECTION 9

Инструменты для имплантологии | Инструменти для імплантології  
 Implantologie | Implantologia  
 Implantologie | زراعة الأسنان

DENTAL IMPLANT



<b>Article#</b> W19-083 Suction Tubes 18cm	<b>Article#</b> W19-084 Suction Tubes 18cm	<b>Article#</b> W19-085 Suction Tubes 18cm	<b>Article#</b> W19-086 Suction Tubes 18cm	<b>Article#</b> W19-087 Suction Tubes 18cm	<b>Article#</b> W19-088 Suction Tubes 18cm	<b>Article#</b> W19-089 Suction Tubes 18cm	<b>Article#</b> W19-090 Suction Tubes 18cm	<b>Article#</b> W19-091 Suction Tubes 18cm	<b>Article#</b> W19-092 Suction Tubes 18cm
--	--	--	--	--	--	--	--	--	--

Frazier Suction Tube Blue Titanium



<b>Article#</b> W19-093 Ø 3 mm length 18cm	<b>Article#</b> W19-094 Ø 4 mm length 18cm	<b>Article#</b> W19-095 Ø 5 mm length 18cm	<b>Article#</b> W19-097 Ø 3 mm length 18cm W19-098 Ø 4 mm length 18cm W19-099 Ø 5 mm length 18cm	<b>Article#</b> W19-096 Fig. 6FR Frazier 15cm - Ø 2 mm	<b>Article#</b> W19-100 17.5cm Ø 20mm	<b>Article#</b> W19-101 18cm Ø 27mm	<b>Article#</b> W19-102 coarse Ø 5mm	<b>Article#</b> W19-103 fine Ø 9mm Suction tubes to collect the extracted bone material 180mm
---	---	---	---	---	--	--	---	---

Article# W19-104  
 LUCAS CURETTE SET OF 5 PCS



LUCAS CURETTE SET OF 7 PCS SERRATED POINT



DENTAL IMPLANT

Инструменты для имплантологии    Инструменти для имплантології  
 Implantologie    Implantologia  
 Implantologie    زراعة الأسنان

DENTAL IMPLANT



Article# WI9-117  
 Gingival Retraction Cord Packers Serrated Set of 3 Pcs



Article# WI9-118  
 Gingival retraction Cord Packers Serrated



Article# WI9-119  
 Gingival retraction Cord Packers Serrated



Article# WI9-120  
 Gingival retraction Cord Packers Serrated



Article# WI9-121  
 Gingival Cord Packer 1.5mm Serrated



Article# WI9-122  
 Gingival Cord Packer 2.5mm Serrated



Article# WI9-123  
 Gingival Cord Packer Serrated



Article# WI9-124  
 Gingival Cord Packer Serrated



Article# WI9-125  
 Retraction Cord Packer 1.5mm



Article# WI9-126  
 Universal Cord Packer 2mm



Article# WI9-127  
 Retraction Cord Packer 2.5mm





SINUS INSTRUMENTS SET OF 10 PCS



DENTAL IMPLANT

With curette the sinus membrane is further detached over a broad area in the inner region, especially along the roof of the palate.

With curette the sinus membrane is further elevated in the upper and posterior part of the maxillary sinus wall.

The "Schneider's Membrane" of the sinus can be detached with curette by 1–2mm along the total cortical bone.

Curette is particularly useful in the lower part for detaching the membrane further. The same goes for the caudal area, especially when the membrane is 4–5 mm above the base of the maxillary sinus and the maxillary sinus is built up with granular material.

Curette makes it possible to lift the membrane further in mesial region. One working tip is especially designed for the right maxillary sinus and the other for the left maxillary sinus.

Sinus Lift Elevator

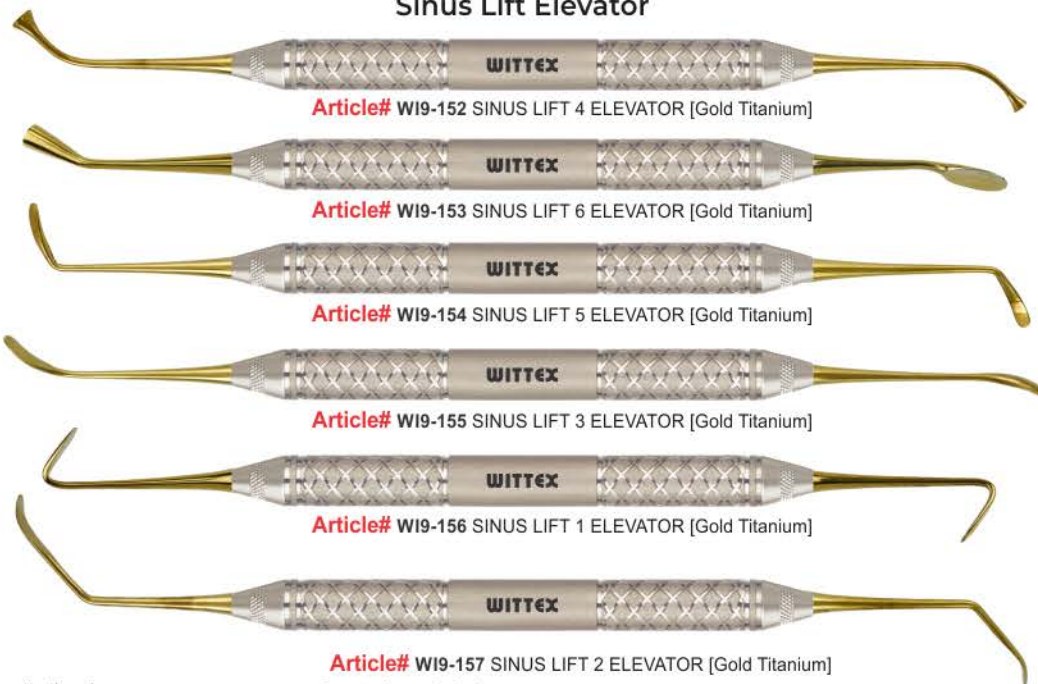

**Article# W19-152 SINUS LIFT 4 ELEVATOR [Gold Titanium]**

**Article# W19-153 SINUS LIFT 6 ELEVATOR [Gold Titanium]**

**Article# W19-154 SINUS LIFT 5 ELEVATOR [Gold Titanium]**

**Article# W19-155 SINUS LIFT 3 ELEVATOR [Gold Titanium]**

**Article# W19-156 SINUS LIFT 1 ELEVATOR [Gold Titanium]**

**Article# W19-157 SINUS LIFT 2 ELEVATOR [Gold Titanium]**

With curette the sinus membrane is further detached over a broad area in the inner region, especially along the roof of the palate.

The "Schneider's Membrane" of the sinus can be detached with curette by 1-2mm along the total cortical bone.

Curette is particularly useful in the lower part for detaching the membrane further. The same goes for the caudal area, especially when the membrane is 4-5 mm above the base of the maxillary sinus and the maxillary sinus is built up with granular material.

Curette makes it possible to lift the membrane further in mesial region. One working tip is especially designed for the right maxillary sinus and the other for the left maxillary sinus.

With curette the sinus membrane is further elevated in the upper and posterior part of the maxillary sinus wall.



**Article# W19-158 SINUS LIFT 1 ELEVATOR [Blue Titanium]**

**Article# W19-159 SINUS LIFT 2 ELEVATOR [Blue Titanium]**

**Article# W19-160 SINUS LIFT 3 ELEVATOR [Blue Titanium]**

**Article# W19-161 SINUS LIFT 4 ELEVATOR [Blue Titanium]**

**Article# W19-162 SINUS MEMBRANE DETACHER [5-3mm. Black Titanium]**

**Article# W19-163 SINUS LIFT ELEVATOR [Black Titanium]**

**Article# W19-164 SINUS LIFT ELEVATOR [Black Titanium]**

**Article# W19-165 SINUS LIFT ELEVATOR [Black Titanium]**

SINUS INSTRUMENTS SET OF 10 PCS

Article# W19-166



Article# W19-167  
Sinus 1



Article# W19-168  
Sinus 2

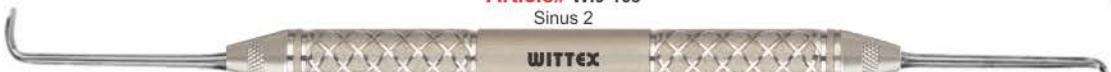

Article# W19-169  
Sinus 3

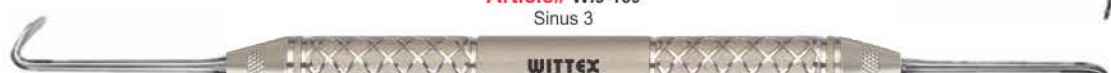

Article# W19-170  
Sinus 4

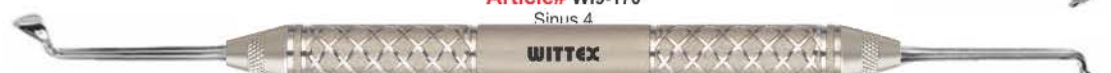

Article# W19-171  
Sinus 5



Article# W19-172  
Sinus 6

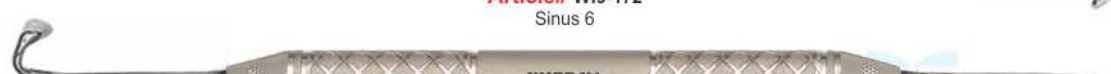

Article# W19-173  
Sinus 7

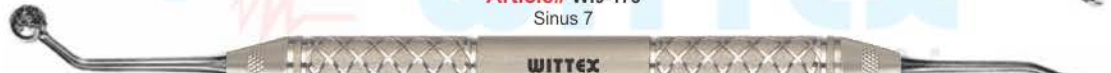

Article# W19-174  
Sinus 8



Article# W19-175  
Sinus 9



Article# W19-176  
Sinus 10



**Flexible Sinus-Lift Curettes – for an optimum sensitivity during the direct lift procedure**

The perforation of the Schneiderian membrane is a complication that often occurs during a maxillary sinus floor augmentation procedure. The Sinus-Lift Instruments increase the sensitivity by blunt and flexible working tips with "Swing-Effect". Because of their special shapes and the characteristic of the stainless steel between the handle and the active part, light pressure is cushioned and gives the operator a direct and sensitive response. At the same time the risk to perforate the Schneiderian membrane is reduced to a minimum. Already at the development the focus was a practicable handling. Because of varying angulations and shapes of the active parts also in difficult areas they are easy to navigate also in difficult areas. The line of curettes consists of six different figures for every situation. They are complemented by spoon and condenser to place the bone graft.



Curette is particularly useful in the lower part for detaching the membrane further. The same goes for the caudal area, especially when the membrane is 4–5 mm above the base of the maxillary sinus and the maxillary sinus is built up with granular material.

■ Инструменты для имплантологии    ■ Инструменти для імплантології  
■ Implantologie    ■ Implantologia  
■ Implantologie    ■ زراعة الأسنان

DENTAL IMPLANT

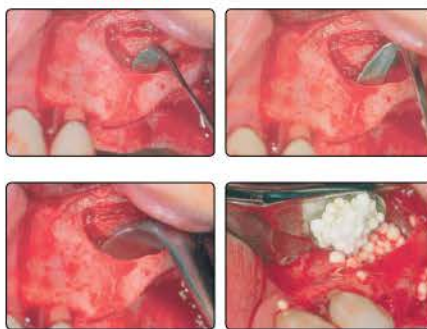

**Flexible Sinus-Lift Curettes – for an optimum sensitivity during the direct lift procedure**  
 The perforation of the Schneiderian membrane is a complication that often occurs during a maxillary sinus floor augmentation procedure. The Sinus-Lift Instruments increase the sensitivity by blunt and flexible working tips with "Swing-Effect". Because of their special shapes and the characteristic of the stainless steel between the handle and the active part, light pressure is cushioned and gives the operator a direct and sensitive response. At the same time the risk to perforate the Schneiderian membrane is reduced to a minimum. Already at the development the focus was a practicable handling. Because of varying angulations and shapes of the active parts also in difficult areas they are easy to navigate also in difficult areas. The line of curettes consists of six different figures for every situation. They are complemented by spoon and condenser to place the bone graft.

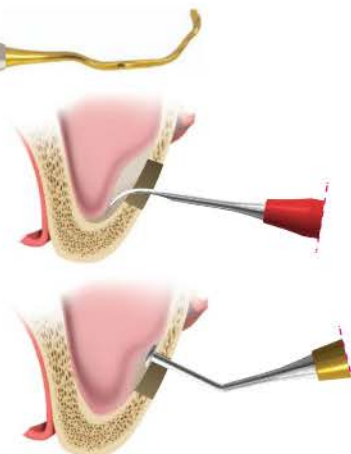

Инструменты для имплантологии  
Implantologie  
Implantologie

Инструменти для імплантології  
Implantologia  
زراعة الأسنان



4.0mm

**SINUS LIFT KIT**  
Article# WI9-187



**Article# WI9-188 Acute**

The acute angle will facility access to the mesial, distal, superior or inferior aspects.



4.0mm



7.4mm



**Article# WI9-189**

It is much the same with but has smaller spoon blade on one side.



4.0mm



5.0mm



**Article# WI9-190 Obtuse**

The obtuse angle will facilitate access the mesial, distal, superior or inferior aspects.



4.0mm



7.4mm



**Article# WI9-191**

It is much the same with but has smaller spoon blade on one side.



4.0mm



5.0mm



**Article# WI9-192**  
Sinus Curette



3.3mm



3.3mm



**Article# WI9-193**  
Sc2

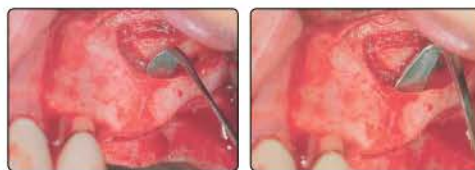

**Flexible Sinus-Lift Currettes – for an optimum sensitivity during the direct lift procedure**

The perforation of the Schneiderian membrane is a complication that often occurs during a maxillary sinus floor augmentation procedure. The Sinus-Lift Instruments increase the sensitivity by blunt and flexible working tips with "Swing-Effect". Because of their special shapes and the characteristic of the stainless steel between the handle and the active part, light pressure is cushioned and gives the operator a direct and sensitive response. At the same time the risk to perforate the Schneiderian membrane is reduced to a minimum. Already at the development the focus was a practicable handling. Because of varying angulations and shapes of the active parts also in difficult areas they are easy to navigate also in difficult areas. The line of currettes consists of six different figures for every situation. They are complemented by spoon and condenser to place the bone graft.

- Инструменты для имплантологии  
■ Implantologie  
■ Implantologie
- Инструменти для имплантології  
■ Implantologia  
■ زراعة الأسنان

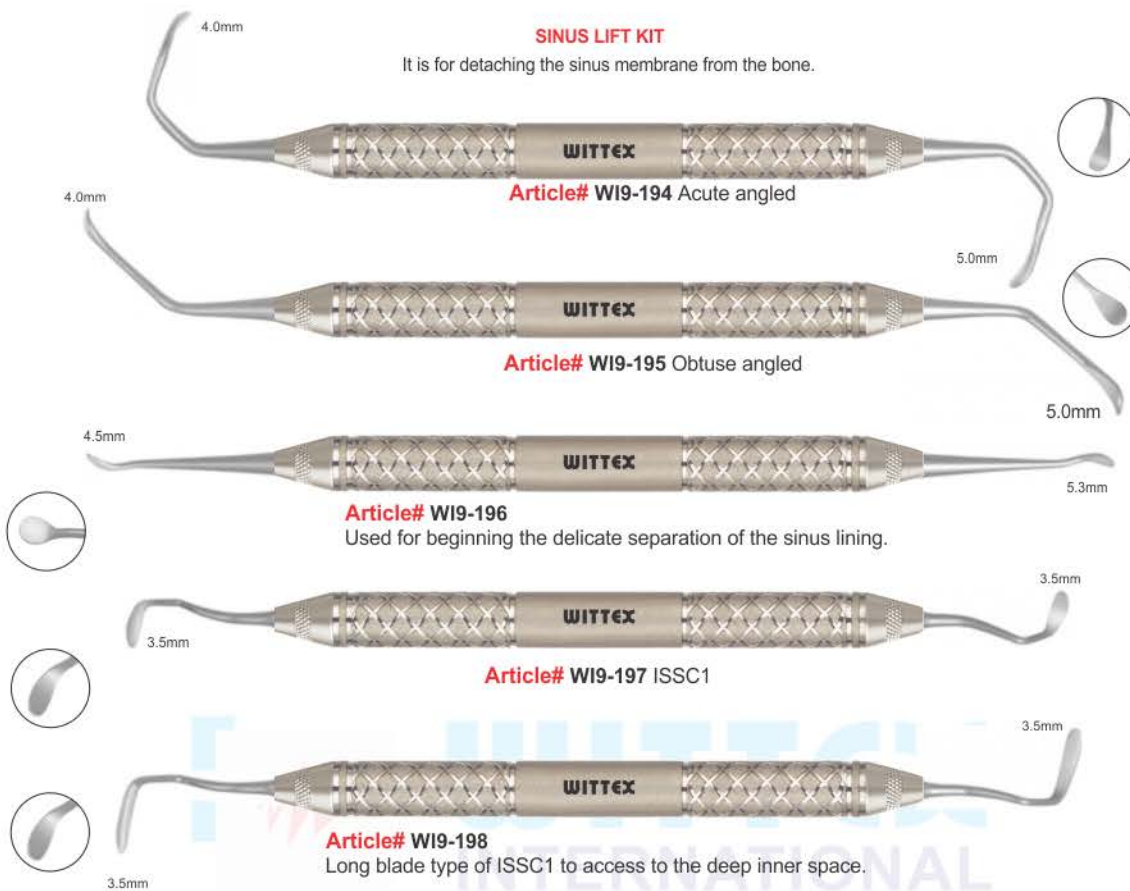

**SINUS LIFT KIT**  
It is for detaching the sinus membrane from the bone.

4.0mm

**SINUS LIFT KIT**

It is for detaching the sinus membrane from the bone.

4.0mm

**Article# WI9-194 Acute angled**

5.0mm

**Article# WI9-195 Obtuse angled**

5.0mm

4.5mm

**Article# WI9-196**

Used for beginning the delicate separation of the sinus lining.

5.3mm

3.5mm

**Article# WI9-197 ISSC1**

3.5mm

3.5mm

**Article# WI9-198**

Long blade type of ISSC1 to access to the deep inner space.

3.5mm



**Flexible Sinus-Lift Curettes – for an optimum sensitivity during the direct lift procedure**

The perforation of the Schneiderian membrane is a complication that often occurs during a maxillary sinus floor augmentation procedure. The Sinus-Lift Instruments increase the sensitivity by blunt and flexible working tips with "Swing-Effect". Because of their special shapes and the characteristic of the stainless steel between the handle and the active part, light pressure is cushioned and gives the operator a direct and sensitive response. At the same time the risk to perforate the Schneiderian membrane is reduced to a minimum. Already at the development the focus was a practicable handling. Because of varying angulations and shapes of the active parts also in difficult areas they are easy to navigate also in difficult areas. The line of curettes consists of six different figures for every situation. They are complemented by spoon and condenser to place the bone graft.



The "Schneider's Membrane" of the sinus can be detached with curette by 1–2mm along the total cortical bone.



Curette is particularly useful in the lower part for detaching the membrane further. The same goes for the caudal area, especially when the membrane is 4–5 mm above the base of the maxillary sinus and the maxillary sinus is built up with granular material.



Curette makes it possible to lift the membrane further in mesial region. One working tip is especially designed for the right maxillary sinus and the other for the left maxillary sinus.

With curette the sinus membrane is further detached over a broad area in the inner region, especially along the roof of the palate.



With curette the sinus membrane is further elevated in the upper and posterior part of the maxillary sinus wall.

**TUNNELING PERIOTOME SURGERY SET OF 10 PCS**



**Article# W19-202** Probe Unc15 Single



**Article# W19-199** Tunneling Knife #1 Upper Jaw/17.5cm



**Article# W19-200** Tunneling Knife #2 Lower Jaw/17.5cm



**Article# W19-201** Tunneling Knife #2 Upper & Lower Jaw/17.5cm



**Article# W19-203** Micro Papilla Elevator 1.5/2.0mm



**Article# W19-205** Micro Blade Holder



**Article# W19-209** Micro needle holder 18cm



**Article# W19-208** Super Sharp Micro scissors 18cm



**Article# W19-207** Micro Diamond Tweezers 18cm



**Article# W19-206** Micro Cooley Forceps 18cm



**Article# W19-204**  
Tunneling Periosteotomy Surgery Set of 10 Pcs with cassette

**TUNNELING MICRO SURGERY KIT**

DENTAL IMPLANT



**Article# WI9-210** 1-2-Allen-Orban-Knife-Black



**Article# WI9-211** 7-8-Younger-Good-Curette



**Article# WI9-212** Allen-Anterior-Periosteal-Elevator-Black



**Article# WI9-213** Allen-End-Cutting-Intrasulcular-Knife-Black-Line



**Article# WI9-214** Allen-Posterior-Periosteal-Elevator-Black



**Article# WI9-215** Tunneling-Instrument-Knife-1-Black



**Article# WI9-216** Tunneling-Instrument-Knife-2-Black

**Article# WI9-218**  
Blade Holder



**Article# WI9-219**  
Micro Blade  
Holder



**Article# WI9-220**  
Castroviejo Microsurgery  
Scissors-18cm



**Article# WI9-221**  
Microsurgical Needle  
Holder Cvd-18cm



**Article# WI9-222**  
Microsurgical Needle  
Holder Str-18cm



**Article# WI9-223**  
Micro Tissue  
Plier  
Str DD 1mm  
18cm



**Article# WI9-217**  
Tunneling Micro Surgery Kit  
of 15 pcs With Cassette



**Article# WI9-224**  
Micro Multiple  
Teeth Tissue Plier  
Curved 18cm



**Article# WI9-225**  
Micro Corn  
Suture Pliers  
18cm



Инструменты для имплантологии  
Implantologie  
Implantologie

Инструменти для імплантології  
Implantologia  
زراعة الأسنان

VISTA Tunneling Set



Article# WI9-226 PERIODONTAL MICROSURGERY VISTA 1 [Tunneling]



Article# WI9-227 PERIODONTAL MICROSURGERY VISTA 2 [Tunneling]



Article# WI9-228 PERIODONTAL MICROSURGERY VISTA 3 [Tunneling]



Article# WI9-229 PERIODONTAL MICROSURGERY VISTA 4 [Tunneling]



Article# WI9-230 PERIODONTAL MICROSURGERY VISTA 5 [Tunneling]



Article# WI9-231 PERIODONTAL MICROSURGERY VISTA 6 [Tunneling]



VISTA Tunneling Set  
Article# WI9-232

Vestibular Incision Subperiosteal Tunnel Access (VISTA), Progressive apical displacement of gingival tissue away from the CEJ results in gingival recession and root exposure. The clinical consequences include root sensitivity, root caries, cervical root abrasions, inadequate plaque control, and aesthetic concern.

The Vestibular Incision Sub Periosteal Tunnel Access (VISTA) is among the documented surgical treatments of gingival recession. Its advantages include minimizing surgical trauma, maintaining better blood supply, preserving papillary integrity, reducing tissue refraction, absence of scar tissue and excellent root coverage.

VISTA technique improves biotype. It successfully treats multiple recession defects. It avoids some of the potential complications of intrasulcular tunneling techniques.

Titanium Nitride (TiN) black coated working points provides optimal edge retention, reduced light reflection and enhanced contrast and visual acuity at the surgical site and underlying tissue.

Large diameter handle (9.5mm) for enhanced ergonomics, tactile feel and optimal clinical performance. Longevity and corrosion resistance afforded by handcrafting from the finest grade surgical stainless steel. Completely Sterilisable.

VISTA Tunneling Set -Vestibular Incision Subperiosteal Tunnel Access Set



Article# WI9-233 Vista Tunneling Elevator n.1



Article# WI9-234 Vista Tunneling Elevator n.2



Article# WI9-235 Vista Tunneling Elevator n.3



Article# WI9-236 Vista Tunneling Elevator n.4



Article# WI9-237 Vista Tunneling Elevator n.5



Article#  
WI9-238

- Инструменты для имплантологии
- Инструменти для імплантології
- Implantologie
- Implantologia
- Implantologie
- زراعة الأسنان

Article# WI9-239

**BONE GRAFTING SET 1**

Blue Titanium Coated Bone Grafting Instruments

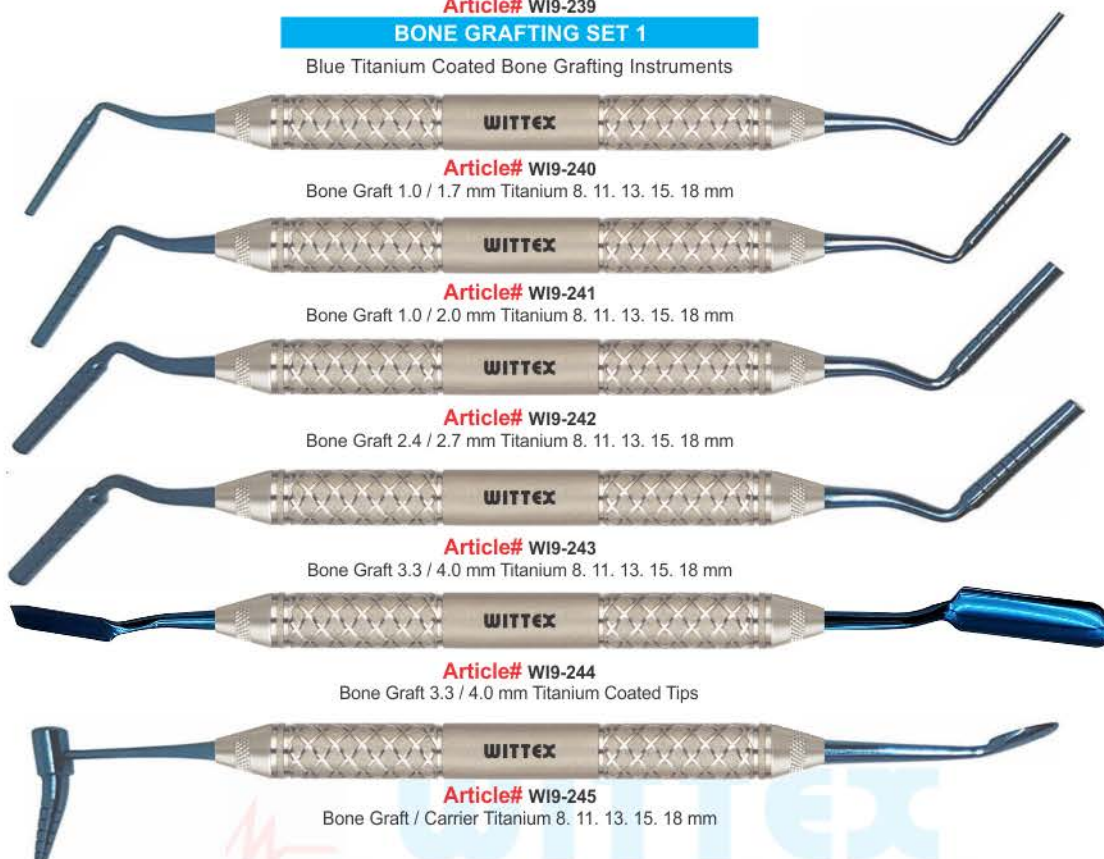

Article# WI9-240

Bone Graft 1.0 / 1.7 mm Titanium 8. 11. 13. 15. 18 mm

Article# WI9-241

Bone Graft 1.0 / 2.0 mm Titanium 8. 11. 13. 15. 18 mm

Article# WI9-242

Bone Graft 2.4 / 2.7 mm Titanium 8. 11. 13. 15. 18 mm

Article# WI9-243

Bone Graft 3.3 / 4.0 mm Titanium 8. 11. 13. 15. 18 mm

Article# WI9-244

Bone Graft 3.3 / 4.0 mm Titanium Coated Tips

Article# WI9-245

Bone Graft / Carrier Titanium 8. 11. 13. 15. 18 mm



Step 1

Step 2

Step 3

Step 4

Step 5

Article# WI9-246

**BONE GRAFTING SET 2**



Concave Tip

Concave Tip

Article# WI9-247

Graft Packer, Concave Tips DE 4/6mm

Article# WI9-248/8mm

Article# WI9-249 3/4mm

3mm

Article# WI9-250 Spoon 3mm

6x10mm

Article# WI9-251 Spoon angled



■ Инструменты для имплантологии    ■ Инструменти для имплантології  
■ Implantologie    ■ Implantologia  
■ Implantologie    ■ زراعة الأسنان

**BONE GRAFT INSTRUMENTS**



**Article# W19-252 IMPLANT BONE GRAFT PACKER CONDENSER**  
[8-11-13-15-18 Serrated. 4mm & 3.3mm]



**Article# W19-253 IMPLANT BONE GRAFT PACKER CONDENSER**  
[8-11-13-15-18 Serrated. 4mm & 3.3mm]



**Article# W19-254 IMPLANT BONE GRAFT PACKER CONDENSER**  
[8-11-13-15-18 Serrated. 4mm & 3.3mm]



**Article# W19-255 IMPLANT BONE GRAFT PACKER CONDENSER**  
[BP Serrated 5mm & 3mm]



**Article# W19-256 BONE AND TISSUE GRAFT PLUGGER & CONDENSER**  
[Black Titanium]



**Article# W19-257 UNIVERSAL BONE PACKER & CARRIER**  
[Blue Titanium]



**Article# W19-258 BONE CARRIER / CONDENSER - SINUS LIFT**  
[Blue Titanium]



**Article# W19-259 IMPLANT BONE GRAFT CARRIER**  
[Blue Titanium]



**Article# W19-260 MODIFIED PERIOSTEAL ELEVATOR**

DENTAL IMPLANT

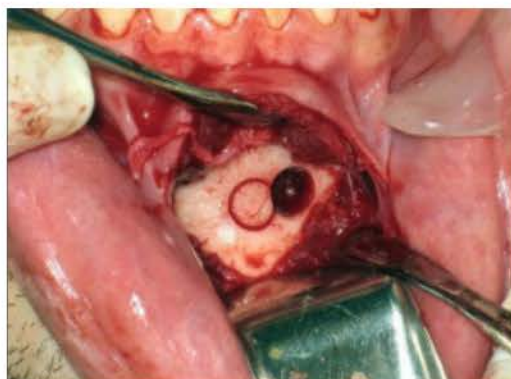

**Dental Bone Graft**



Bone Grafting is a complex and risky procedure and it sometimes get infected while healing. The dental bone graft cost also expensive.

So, Dr. Motiwala comes up with a new technique called Permanent teeth in 3 days without Bone Graft procedure.

@ www.full-mouth-dental-implants.com

- Инструменты для имплантологии  
■ Implantologie  
■ Implantologie
- Инструменти для имплантології  
■ Implantoloia  
■ زراعة الأسنان

**BONE GRAFTING INSTRUMENTS**

This section includes bone grafting applicators, compactors and bone grafting Condensers. All grafting instruments are made with surgical grade steel. Completely Sterilizable Satin surface finish. Black coated working points provides optimal edge retention, reduced light reflection and enhanced contrast and visual acuity at the surgical site and underlying tissue.



**Article# WI9-261** Bone Grafting Applicator, 12mm/16mm, DE



**Article# WI9-262** Bone Grafting Applicator, 6mm/10mm, DE



**Article# WI9-263** Bone Compactor Ø6.0mm/8.0mm, DE



**Article# WI9-264** Bone Compactor Ø3.0mm/4.0mm, DE



**Article# WI9-265** Jovanovic Universal Condenser, 3mm/4mm, DE

**Article# WI9-266** Jovanovic Universal Condenser, 3mm/3mm, DE

Large diameter handle (9.5mm) for enhanced ergonomics, tactile feel and optimal clinical performance. Longevity and corrosion resistance afforded by handcrafting from the finest grade surgical stainless steel. Completely Sterilizable.



Step 1

Step 2

Step 3

Step 4

Step 5

**PRF/GRF INSTRUMENTS SET**



**Article# WI9-267** Bone Grafting Applicator, 12mm/16mm, DE



**Article# WI9-268** Bone Grafting Applicator, 6mm/10mm, DE



**Article# WI9-269** Bone Compactor Ø6.0mm/8.0mm, DE



**Article# WI9-270** Bone Compactor Ø3.0mm/4.0mm, DE



**Article# WI9-273**  
Tube Holder, for 12 tubes



**Article# WI9-274**  
Mixing Bowl for bone material,  
28mm, Ø65mm



**Article# WI9-271**  
Goldman-Fox, Str. TC Scissor, 12.5cm



**Article# WI9-272** 1x2 General TC Tissue Plier, 15cm



**Article# WI9-275**  
PRF Box, with lid and Cover

Инструменты для имплантологии  
Implantologie  
Implantologie

Инструменти для імплантології  
Implantologia  
زراعة الأسنان

**BONE SCRAPER STRAIGHT & CURVED**



**Article# WI9-276**  
Bone Scraper  
Straight

**Article# WI9-277**  
Bone Scraper  
Curved

**TISSUE PUNCH STRAIGHT & CURVED**



**Article# WI9-278**  
2.0mm

**Article# WI9-279**  
4.0mm

**Article# WI9-280**  
5.0mm

**Article# WI9-281**  
6.0mm

**Article# WI9-282**  
7.0mm

**Article# WI9-283**  
8.0mm

**Article# WI9-284**  
2.0mm

**Article# WI9-285**  
4.0mm

**Article# WI9-286**  
5.0mm

**Article# WI9-287**  
6.0mm

**Article# WI9-288**  
7.0mm

**Article# WI9-289**  
8.0mm

Tissue Punch  
Straight

Tissue Punch  
Curved



**Article# WI9-290**  
Bone Mill

**Article# WI9-291**  
Basins For Bone



**Article# WI9-292**  
Bone Morselizer Mill Crusher  
With Titanium Plates



**Article# WI9-293**  
Dental Bur Cleaning  
Brush Copper

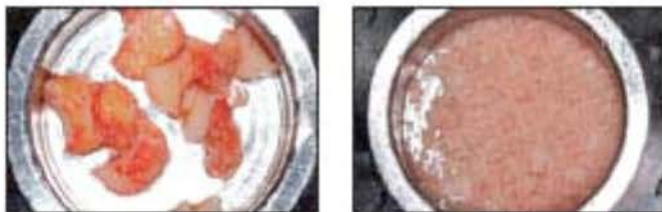

BONE MILL BONE WELL



Article# W19-294  
BONE CRUSHER  
Titanium Metal Cutter

mallet



Article# W19-298  
Gold Mill (Small)

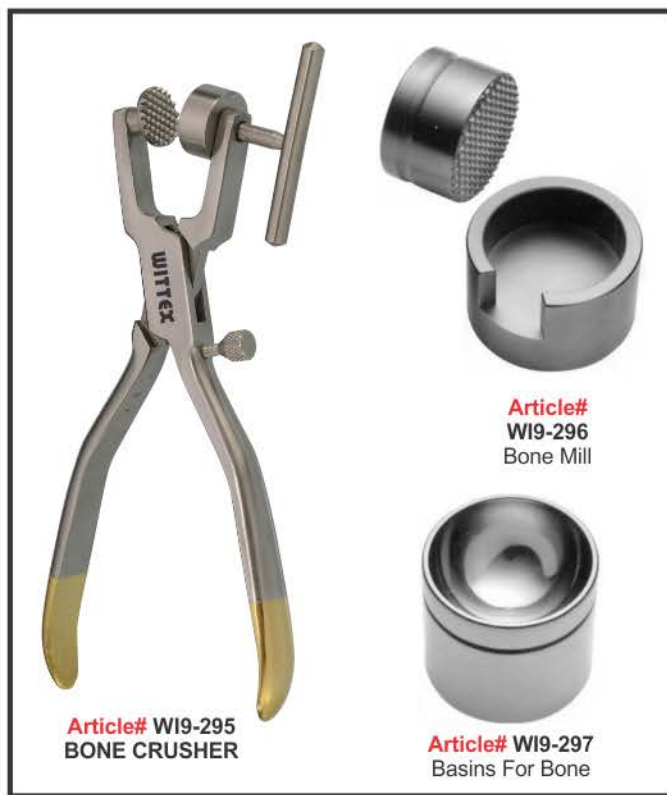

Article# W19-295  
BONE CRUSHER

Article# W19-296  
Bone Mill

Article# W19-297  
Basins For Bone



Article# W19-299  
Gold mill (Large)

KEYS FOR IMPLANT SCREW



Article# WI9-300



Article# WI9-301



Article# WI9-302



Article# WI9-303

TORQUE WRENCH & RATCHET



Article# WI9-304  
Star Torque Wrench 6.35mm Universal



Article# WI9-310  
Star Torque Wrench 6.35mm Universal



Article# WI9-316  
Star Ratchet Wrench 6.35mm Universal



Article# WI9-305  
Round Torque Wrench 4.0mm Universal



Article# WI9-311  
Star Torque Wrench 6.35mm Universal



Article# WI9-317  
Star Ratchet Wrench 4.0mm Universal



Article# WI9-306  
Hex Driver With 4.0mm Driver



Article# WI9-312  
Star Torque Wrench 6.35mm Universal



Article# WI9-318  
Round Ratchet Wrench 4.0mm Universal



Article# WI9-307  
Star Torque Wrench 6.35mm Universal



Article# WI9-313  
Star Torque Wrench 6.35mm Universal



Article# WI9-319  
Round Ratchet Wrench 3.35mm Universal



Article# WI9-308  
Hex Torque Wrench 4.00mm Universal



Article# WI9-314  
Star Ratchet Wrench 6.35mm Universal



Article# WI9-320  
Star Ratchet Wrench 4.0mm Universal



Article# WI9-309  
Star Torque Wrench 6.35mm Universal



Article# WI9-315  
Star Ratchet Wrench 6.35mm Universal



Article# WI9-321  
Star Ratchet Wrench 6.35mm Universal



**Artical # WI9-322**  
Bone Chip Maker 2



**Artical # WI9-323**  
Tissue Punch & Trepine Bur & Saw Set





**Artical # WI9-326**  
**Trimmer Kit**  
The Kit Includes:  
**1) Trepine Drills**  
3.0mm, 4.0mm  
5.0mm, 6.0mm  
7.0mm

- 2) Tissue Punch**  
3.5mm, 4.0mm  
4.5mm, 5.0mm  
5.5mm  
**3) Guide Punch**  
4.0mm, 5.0mm  
**4) Saw Disks**  
7.0mm, 10.0mm  
**5) Sterilization Cassette.**



**Artical # WI9-327**  
**Bone Compression Kit**  
The Kit Includes:  
**Convex Compression Screws**  
1.6/2.7mm, 2.0/3.3mm  
2.4/3.6mm, 3.1/4.1mm

- Cancave Compression Screws**  
3.0mm, 3.5mm, 4.0mm  
**Spade Marking Drill**  
Motor Mount Drivers Long & Short  
Hand Driver  
Ratchet Adapter  
Ratchet Wrench



**Artical # WI9-328**  
**Surgical Drill Kit**  
The Kit Includes:  
**1) Twist Drills**  
2.0mm, 2.8mm  
3.2mm, 3.65mm  
4.2mm, 4.8mm, 5.2mm  
With Laser Depth Markings on 6.0mm,  
8.0mm, 10.0mm, 11.5mm, 13.0mm & 16.0mm  
**2) Ratchet / Wrench Hex Drivers (Color Coded)**  
1.25mm Short / Long, 2.42mm Short / Long  
**3) Parallel Pins**  
Long & Short  
**4) Motor Mount Hex**  
1.25mm, 2.5mm  
**5) Ratchet Wrench 4mm**  
**6) Sterilization Cassette / Box / Organizer**



**Artical # WI9-329**

**Universal Kit 50 PCS**

The Kit Includes:

**16pcs Conical Drills with Stoppers**

- 1.8mm / 2.2mm - S1, 1.8mm / 2.2mm - S3
- 1.8mm / 2.2mm - S5, 1.8mm / 2.2mm - S7
- 2.2mm / 2.7mm - S1, 2.2mm / 2.7mm - S3
- 2.2mm / 2.7mm - S5, 2.2mm / 2.7mm - S7
- 2.3mm / 3.3mm - S1, 2.3mm / 3.3mm - S3
- 2.3mm / 3.3mm - S5, 2.3mm / 3.3mm - S7
- 2.8mm / 4.5mm - S1, 2.8mm / 4.5mm - S3
- 2.8mm / 4.5mm - S5, 2.8mm / 4.5mm - S7

**Bone Expander Screws**

- 1.6mm / 2.6mm, 1.9mm / 3.0mm
- 2.9mm / 3.4mm, 2.3mm / 3.8mm
- 2.9mm / 4.3mm,

**Titanium Coated Drills**

- Drill Bit 2.0mm L 18.50, Drill Bit 2.8mm L 18.50
- Drill Bit 3.65mm L 18.50, Drill Bit 4.2mm L 18.50
- Drill Bit 4.5mm L 18.50, Drill Bit 4.8mm L 18.50
- Drill Bit 5.2mm L 18.50

**8pcs Trephine Drills**

- Int: 2.0mm, Ext: 3.0mm, Int: 3.0mm, Ext: 4.0mm
- Int: 4.0mm, Ext: 5.0mm, Int: 5.0mm, Ext: 6.0mm
- Int: 6.0mm, Ext: 7.0mm, Int: 7.0mm, Ext: 8.0mm
- Int: 8.0mm, Ext: 9.0mm, Int: 9.0mm, Ext: 10.0mm
- Compression Screw 2.8 / 4.0mm, Compression Screw 4.0mm
- Driver 2.5mm
- Compression Screw 2.0 / 2.8mm, Compression Screw 2.8 / 3.4mm
- Tissue Punch 4.5mm, Tissue Punch 5.8mm
- Pilot Drill 2.0mm
- Drill Extender
- Ratchet Driver 2.5mm, Hand Driver 2.5mm
- Torque Wrench 6.35mm (10-40Ncm)
- Depth Gauge
- Sterilization Cassette / Box



**Artical # WI9-330**

**Conical Implant Drill Kit**

The Kit Includes:

**Drills Sizes:**

- 1.8mm / 2.2mm, 2.2mm / 2.7mm
- 2.3mm / 3.3mm, 2.7mm / 3.7mm
- 2.7mm / 4.5mm

**Stopper Sizes:**

- 1.0mm / L 13.0, 2.0mm / L 11.5
- 3.0mm / L 10.0, 5.0mm / L 8.0
- 7.0mm / L 6.0

**Overall Drills Length:**

- 13.0mm (32mm with Shaft)



**Artical # WI9-331**  
**Compression Expander Screws Kit**

The Kit Includes:  
 Kit Includes  
 3x Bone Compression Screws  
 1x Sinus Elevation Screw (3.5mm)  
 Screws are compatible with any brands 4.0mm Torque Wrench / Ratchet Wrench / Adapter's  
 Kit Advantages  
 Screws are Laser marked to indicate the depth of 8mm, 10mm & 13mm



**Artical # WI9-332**  
**Hex Drivers Adapter Kit**

The Kit Includes:  
 4 Pcs Hex Drivers Kit Fits Ratchet / Torque Wrench  
 2 x 25mm & 2x 2.5mm Long & Short Driver  
 Manufactured from High Grade Stainless Steel - Highly Polished

DENTAL IMPLANT



**Artical # WI9-333**  
**Bone Expander Kit**

The Kit Includes:  
**1) Expander Screws**  
 1.6 / 2.6 mm, 1.9 / 3.0 mm, 2.1 / 3.4 mm  
 2.6 / 3.8 mm, 2.9 / 4.3 mm  
 With Laser Depth Markings on 8mm, 10mm & 11.5mm.  
**2) Saw Disks**  
 7.0 mm, 10.0 mm  
**3) Pilot Drill 1.6mm**  
**4) Hand piece Adapter**  
**5) Ratchet Extender**  
**6) Hand Driver**  
**7) Ratchet Wrench 4.0mm**  
**8) Sterilization Cassette / Box.**



**Artical # WI9-334**  
**Bone Compact Kit**

The Kit Includes:  
**1) Twist Drills**  
 2.0mm, 2.5mm, 2.8mm 3.2mm, 3.65mm, 4.2mm, 5.2mm  
 With Laser Depth Markings on 6.0mm, 8.0mm, 10.0mm, 11.5mm, 13.0mm & 16.0mm  
**2) Ratchet / Wrench Hex Drivers**  
 (Color Coded)  
 1.25mm Short / Long, 2.42mm Short / Long  
**3) Contra Angle Hex Drivers**  
 1.25mm, 2.42mm  
**4) Parallel Pins Long & Short**  
**5) Drill Extender**  
**6) Marking Drill**  
**7) Ratchet Wrench 6.35mm**  
**8) Sterilization Cassette / Box / Organizer**

BONE EXPANDER SCREW & SURGICAL KITS



**Artical # W19-335**  
Bone Universal Kit  
Drill: 2mm, 2.8mm, 3.2mm, 3.65mm, 4.2mm, 4.5mm, 4.8mm, 5.2mm  
Trephines Bit: 3.0mm, 4.0mm, 5.0mm, 6.0mm, 7.0mm, 8.0mm, 9.0mm, 10mm.  
Driver: 2.5mm, 2.5mm Hand Pcs  
1.25mm, 1.25mm Hand Pcs  
Short Driver 2.5mm  
Long Driver 2.5mm  
1.25mm, Short Hex Driver Hand Pcs  
1.25mm, Long Hex Driver Hand Pcs  
Torque Wrench 4.0mm



**Artical # W19-336**  
Bone Expander Kit  
Expander: 2.6mm, 3.0mm, 3.4mm, 3.8mm, 4.3mm  
Ratchet Driver  
Parallel Pin  
Pilot Drill  
Drill 1.4mm  
Drill Driver 4mm  
Hand Driver 4mm  
Ratchet 4.0mm



**Artical # W19-337**  
Bone Universal Kit  
Drill: 2mm, 2.8mm, 3.2mm, 3.65mm, 4.2mm, 4.5mm, 4.8mm, 5.2mm  
Trephines Bit: 3.0mm, 4.0mm, 5.0mm, 6.0mm, 7.0mm, 8.0mm, 9.0mm, 10mm.

Bone Compression:  
2mm, 3.3mm, 2.8mm, 4.2mm, 3mm, 3.5mm  
Driver: 2.5mm, 2.5mm Hand Pcs  
1.25mm, 1.25mm Hand Pcs  
Short Driver 2.5mm  
Long Driver 2.5mm  
1.25mm, Short Hex Driver Hand Pcs  
1.25mm, Long Hex Driver Hand Pcs  
Torque Wrench 6.35mm 1 Pcs



**Artical # W19-338**  
Conical Drills: 20 Pcs  
Tissue Punches: 3.0mm, 3.50mm, 4.0mm, 4.5mm, 5.0mm, 6.0mm, 6.50mm  
Bone Expander: 1.6/3.8mm, 1.9/3.0mm, 2.1/3.6mm, 2.6/3.8mm, 2.9/4.3mm  
Drill Adapter: 1 Pcs  
1.25mm, 2.50mm Hex Driver Hand Pcs

Pilot Drill: 1.6mm  
Drill Bit: 1.4mm, 1.6mm, 1.8mm, 2.0mm, 2.2mm  
Ratchet Driver: 4mm/6.35, 1.25/2.50  
Rimer: 3.2/4.7mm, 3.7/4.7mm  
Parallel Pin: 4.5mm, 2.5mm  
Double step Drill: 2.4/2.8mm  
Depth Gauge: 1 Pcs  
Torque Wrench 6.35mm Universal: 1 Pcs



**Artical # WI9-339**  
Densah Burs Kit with Stoppers  
The Kit Includes:  
21pcs Conical Drills Surgical Bur Kit



**Artical # WI9-340**  
Densah Burs Kit with Stoppers  
The Kit Includes:  
22pcs Conical Drills Surgical Bur Kit



**Artical # WI9-341**  
Surgical Drills with Stopper Kit  
The Kit Includes:  
21pcs



**Artical # WI9-342**  
Densah Burs Kit with Stoppers  
The Kit Includes:  
21pcs Conical Drills Surgical Bur Kit



**Artical # WI9-343**  
**Drills kit (Black Coated)**  
The Kit Includes:  
**Dental Drills Implant Kit 8 Pcs**  
**Drill Sizes:**  
2.0mm, 2.5mm, 2.8mm, 3.2mm,  
3.65mm, 4.2mm, 5.2mm, 5.5mm  
Marking Depths on the drills  
for accurate drilling,  
Sizes 6.0mm, 8.0mm, 10.0mm,  
11.5mm, 13.0mm & 16.0mm.



**Artical # WI9-344**  
**Drill Kit (Polished)**  
The Kit Includes:  
**Dental Drills Implant Kit 8 Pcs**  
**Drill Sizes:**  
2.0mm, 2.5mm, 2.8mm, 3.2mm,  
3.65mm, 4.2mm, 5.2mm, 5.5mm  
Marking Depths on the drills for  
accurate drilling,  
Sizes 6.0mm, 8.0mm, 10.0mm,  
11.5mm, 13.0mm & 16.0mm.

The Kit Includes:

- 1.8mm Pilot Drill
- 1525 (2.0mm)
- 2535 (3.0mm)
- 3545 (4.0mm)
- 4555 (5.0mm)
- 1828 (2.3mm)
- 2838 (3.3mm)
- 3848 (4.3mm)
- 4858 (5.3mm)
- 2228 (2.5mm)
- 3238 (3.5mm)
- 4248 (4.5mm)
- 5258 (5.5mm)



**Artical # WI9-345**  
**Osseodensification Burs Kits**



**Artical # WI9-346**  
**Osseodensification Burs Kit**  
The Kit Includes:  
12pcs Conical Drills



**Artical # WI9-347**  
**Osseodensification Burs Kit**  
The Kit Includes:  
18pcs Conical Drills Kit



**Artical # WI9-348**  
**Osseodensification Burs Kit**  
The Kit Includes:  
13pcs Conical Drills



**Artical # WI9-349**  
**Positioning Kit**  
The Kit Includes:  
11pcs Drills Guide & Implants



**Artical # W19-350**  
**Premium Surgical Drill Kit**  
The Kit Includes:  
**44pcs Drills**



**Artical # W19-351**  
**Premium Surgical Drill Kit**  
The Kit Includes:  
**51pcs Drills**



**Artical # W19-352**  
**Premium Surgical Drill Kit**  
The Kit Includes:  
**26pcs Drills**



**Artical # W19-353**  
**Premium Surgical Drill Kit**  
The Kit Includes:  
**24pcs Drills**



**Artical # W19-354**  
**Bone Expander and Chisel Kit**  
The Kit Includes:  
**16pcs Chisel and Expander**



**Artical # W19-355**  
**Sinus and Stopper Kit**  
The Kit Includes:  
**14pcs**



**Artical # W19-356**  
**Sinus and Stopper Kit**  
The Kit Includes:  
**14pcs**



**Artical # W19-357**  
**Sinus and Stopper Kit**  
The Kit Includes:  
**14pcs**



**Artical # W19-357A**  
**Sinus and Stopper Kit**  
The Kit Includes:  
**16pcs**



**Artical # W19-358**  
**Dental Implant Titanium Bushes Kit**  
The Kit Includes:  
6pcs Bushes



**Artical # W19-359**  
**Lance Drill Kit**  
The Kit Includes:  
4pcs Drill



**Artical # W19-360**  
**Bone Screw Kit**  
The Kit Includes:  
5pcs Screw



**Artical # W19-361**  
**Screwdrivers Kit**  
The Kit Includes:  
8pcs Screwdriver



**Artical # WI9-362**  
**Saw And Trepine Kit**  
The Kit Includes:  
6pcs Trepine



**Artical # WI9-363**  
**Saw And Trepine Kit**  
The Kit Includes:  
6pcs Trepine



**Artical # WI9-364**  
**Fixture Remover Screw Kit**  
The Kit Includes:  
3pcs Screw



**Artical # WI9-365**  
**Fixture Remover Screw Kit**  
The Kit Includes:  
3pcs Screw



**Artical # WI9-366**  
**Lance Drills Kit**  
The Kit Includes:  
3pcs Drills

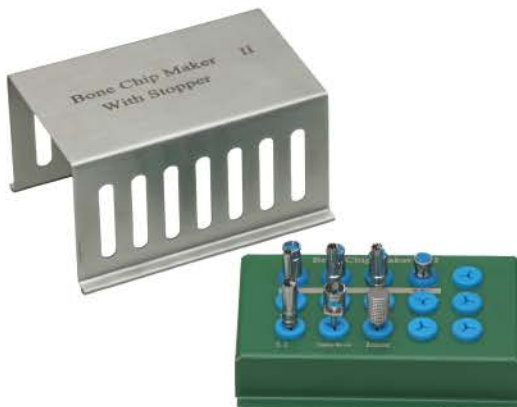

**Artical # WI9-367**  
**Bone Chip Maker II With Stopper**  
The Kit Includes:  
10pcs



**Artical # WI9-368**  
**Dental Residual Root Drill Kit**  
The Kit Includes:  
3pcs Drills



**Artical # WI9-369**  
**Para Drill Aid**  
The Kit Includes:  
8pcs Drills



**Artical # WI9-370**  
Dental Implant Drills



**Artical # WI9-371**  
Dental Implant Drills



**Artical # WI9-372**  
Dental Implant Drills



**Artical # WI9-373**  
Dental Implant Drills



**Artical # WI9-374**  
Dental Implant Drills



**Artical # WI9-375**  
Dental Guide Positioning Kit



**Artical # WI9-376**  
Trephin Drill Kits



**Artical # WI9-377**  
Trephin Drill Kits



**Artical # WI9-378**  
Trephin Drill Kits



**Artical # WI9-379**  
Trephin Drill Kits



**Artical # WI9-380**  
Tissue Punch Kit



**Artical # WI9-381**  
Tissue Punch Kit



**Artical # WI9-382**  
Tissue Punch Kit



**Artical # WI9-383**  
Tissue Punch Kit



**Artical # WI9-384**  
Bone Saw Kit



**Artical # WI9-385**  
Lateral Approach Sinus Lift Kit



**Artical # WI9-386**  
Lateral Approach Sinus  
Lift Drills





**Artical # WI9-392**  
Ruler Measuring gauge



**Artical # WI9-393**  
Ruler Measuring gauge



**Artical # WI9-394**  
Measuring gauge



**Artical # WI9-395**  
Measuring gauge



**Artical # WI9-396**  
Measuring gauge



**Artical # WI9-397**  
Screws and handle

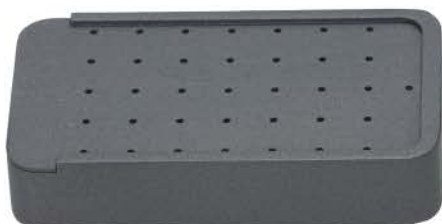

**Artical # WI9-398**  
Screws & Handel Kit



- Инструменты для имплантологии
- Инструменти для имплантології
- Implantologie
- Implantologia
- Implantologie
- زراعة الأسنان

**DENTAL IMPLANT GUIDED BONE REGENERATION GBR KIT**



**Article# W19-399**  
Graft packer, short flexible, Straight ,titanium, Serrated 3mm/4mm



**Article# W19-400**  
Graft Packer, Long, Titanium 8. 11. 13. 15. 18 mm Smooth 3.3 / 4.0 mm



**Article# W19-401** Buser Periosteal Elevator, Flat Tip, Titanium



**Article# W19-402** Kirkland Periodontal Chisel, Titanium 13KL/LR



**Article# W19-403** Rhodes back-Action 36/37



**Article# W19-404** Prichard Pr3 Periosteal Elevator, Titanium



**Article# W19-405** Bone Graft 3.3mm/ 4.0mm Titanium Coated Tips

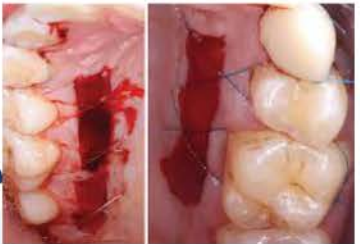
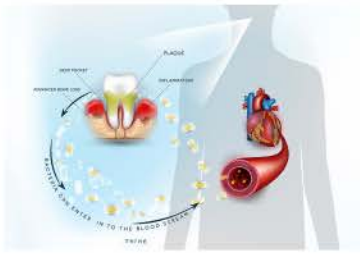

**Article# W19-406**  
Scalpel Handle straight, for blades # 10 -15, 14.5 cm



**Article# W19-407**  
Micro Surgical Scalpel Handle Fig. 3 12.5cm



**Article# W19-408**  
Goldman-Fox 13 cm Saw edge, Curved



Forceps  
**Article# W19-410**  
18cm



**Article# W19-411**  
Bone Scraper Straight



Micro Scissors TC Straight  
**Article# W19-412**  
18cm



**Article# W19-413**  
Cassette Tray 15 Pcs



**Article# W19-414**  
Basins For Bone

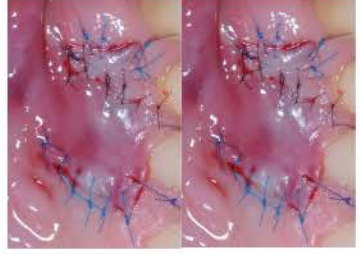

DENTAL IMPLANT



**Periodontal Regeneration**

**IMPLANT SURGERY KIT**

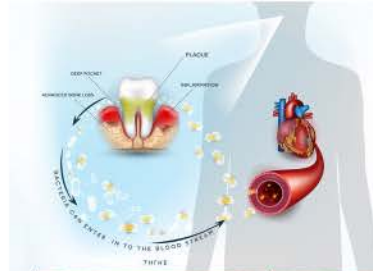

**Article# WI9-433**  
Set of 18 Pcs with cassette  
Instruments Tray 20x14.5x3cm

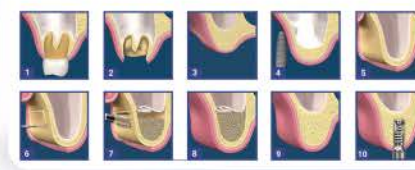

**DENTAL IMPLANT SURGERY KIT**

**DENTAL IMPLANT**

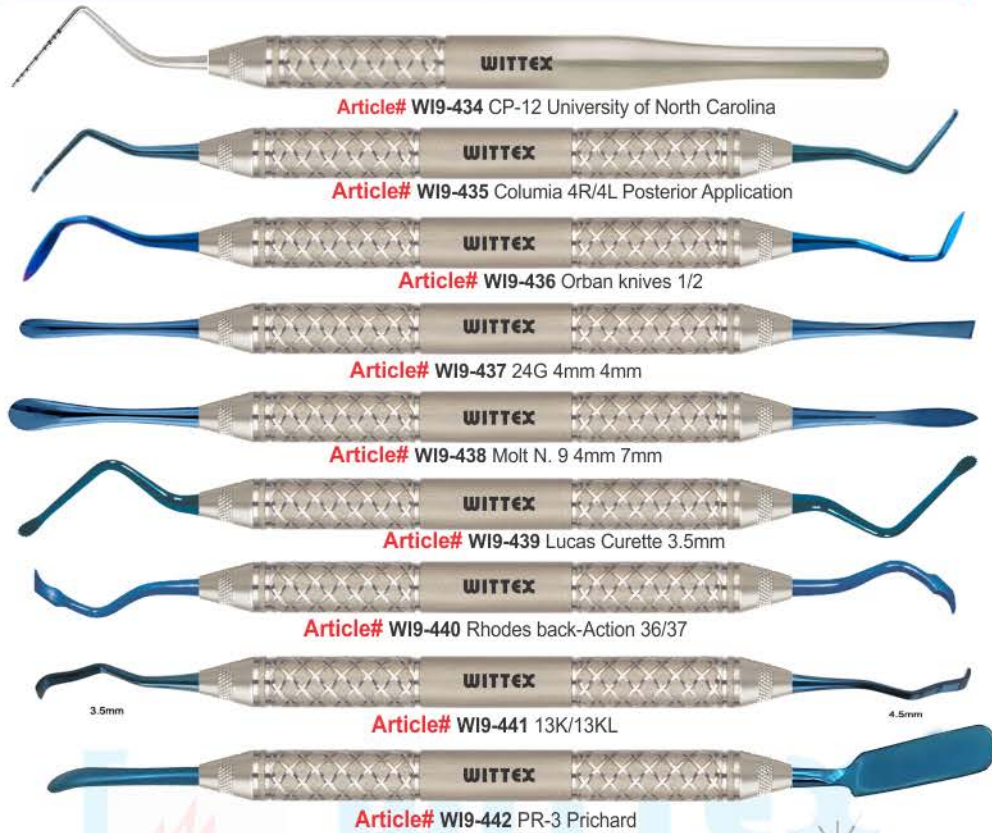

**Article# W19-434** CP-12 University of North Carolina

**Article# W19-435** Columbia 4R/4L Posterior Application

**Article# W19-436** Orban knives 1/2

**Article# W19-437** 24G 4mm 4mm

**Article# W19-438** Molt N. 9 4mm 7mm

**Article# W19-439** Lucas Curette 3.5mm

**Article# W19-440** Rhodes back-Action 36/37

**Article# W19-441** 13K/13KL

**Article# W19-442** PR-3 Prichard



**Article# W19-443**  
Iris Scissors T.c  
3.5cm

**Article# W19-444**  
Mayo-Hegar  
16cm

**Article# W19-445**  
Micro Scissors TC  
Straight  
18cm

**Article# W19-446**  
Micro Scissors TC  
Curved  
18cm

**Article# W19-447**  
Forceps  
18cm

**Article# W19-448**  
Minnesota  
Large  
16cm

**Article# W19-449**  
Scalpel Handle  
straight, for blades  
# 10 -15, 14.5 cm

**Article# W19-450**  
Micro Surgical  
Scalpel Handle

**Article# W19-451**  
Scalpel Handle  
movable

**Article# W19-452**  
Cassette Tray 17 Pcs



**DENTAL IMPLANT**

Uppam spiam dicit ut amet, ut ea neque neque.  
Qui et lacus nulla utamur, vel vivendo  
suscipiamus ea, ex prolo prolo prolo sum nos.  
Hic dicit efficit consetetur et, et vellet ut utamur nos.  
pena neque donec conset, et conset dicit utamur con.  
Hic utamur utamur ut ut.

shutterstock.com - 1751345996



Periodontal Bone Defects



Bone Defects Following Extraction



Defects Following Cyst/Tumor Surgery



Bone Defects Around Implants

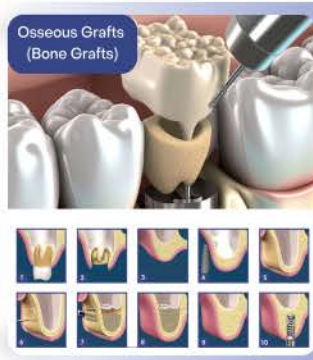

**Osseous Grafts  
(Bone Grafts)**



Инструменты для имплантологии  
Implantologie  
Implantologie

Инструменти для имплантології  
Implantologia  
زراعة الأسنان

**PERIODONTAL MICRO SURGERY KIT**



**Article# W19-453**  
Back Action 90 Dissector, blunt



**Article# W19-454**  
Papillex Scalpel, Sharp, 4mm



**Article# W19-455**  
Spoon, 6mm Plugger, 5mm



**Article# W19-456**  
Palatal Raspatory



**Article# W19-457**  
Prichard Spatula Prichard Raspatory, 4mm



**Article# W19-458**  
Curette Lucas, 2.5mm



**Article# W19-459**  
Curette curved Lange 1/2



**Article# W19-460**  
Curette straight Lange 5/6



**Article# W19-461**  
Hygienist, very fine version # H6 / # H7



**Article# W19-462**  
Probe # 3A Probe North Carolina CNC



**Article# W19-463**  
Tunneling instrument # 1



**Article# W19-464**  
Tunneling instrument # 2



**Article# W19-465**  
Tunneling instrument combination,  
straight (1.8 mm wide) / angled (1.7 mm wide),



**Article# W19-466**  
Round Retractor



**Article# W19-467**  
Mouth Mirror with Lip Retractor



**Article# W19-468**  
Gap Plugger, distal angle



**Article# W19-469**  
Scalpel Handle straight for # 10-15,



**Article# W19-470**  
Micro Surgical Scalpel Handle



**Article# W19-471** 18cm Forceps



**Article# W19-472** Iris Scissors 11.5cm Straight Black Coated



**Article# W19-473** 18cm Micro Scissors TC Curved



**Article# W19-474** 18cm Micro Scissors TC Straight



**Article# W19-475** Periodontal Micro Surgery Set of 22 Pcs With cassette

DENTAL IMPLANT



(a)



(b)



(c)



(d)



(e)

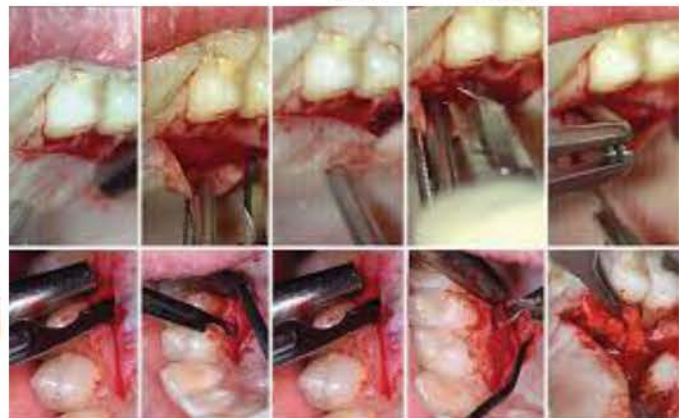

Инструменты для имплантологии  
 Implantologie  
 Implantologie

Инструменти для имплантології  
 Implantologia  
 زراعة الأسنان

DENTAL IMPLANT

In micro surgery, Tunneling Instruments find their application in the preparation of laps or subsequent reconstructions of the alveolar ridge or for root coverings with a connective tissue graft. This tunneling instruments set allow a minimally invasive tunneling preparation to avoid large openings. Due to the fine shaped raspatories tunneling incisions in the tissue are possible.

The modified instruments curved beyond the working tip allow even better access, especially in the posterior tooth region. A user can select the ideal instrument for his/her purposes.

This set includes the Micro Surgical Needle Holder & a Micro Surgical Tissue Plier, both have fine Diamond Dusted working tips. A perfect set for surgical and tunnelling procedures.



TUNNELING INSTRUMENTS SET

Article# WI9-476

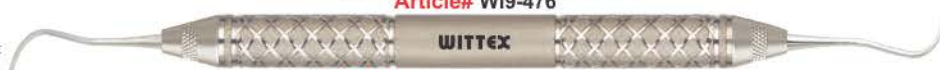

Article# WI9-477 7/8 Younger-Good Curette



Article# WI9-478 1/2 Allen Orban Knife



Article# WI9-479 End-Cutting Intracuticular Knife



Article# WI9-480 Periosteal Elevators, Anterior



Article# WI9-481 Periosteal Elevators



Article# WI9-482 Tunneling Knife #2



Article# WI9-483 Tunneling Knife #1



Article# WI9-484 Micro Blade Scalpel Handle, 14cm



Article# WI9-485 Micro Tissue Plier, Str. DD, 18cm



Article# WI9-486 Micro Castroviejo Needle Holder, Str. DD, 18cm



In micro surgery, Tunneling Instruments find their application in the preparation of laps or subsequent reconstructions of the alveolar ridge or for root coverings with a connective tissue graft. This tunneling instruments set allow a minimally invasive tunneling preparation to avoid large openings. Due to the fine shaped raspatories tunneling incisions in the tissue are possible.

The modified instruments curved beyond the working tip allow even better access, especially in the posterior tooth region. A user can select the ideal instrument for his/her purposes.

This set includes the Micro Surgical Needle Holder & a Micro Surgical Tissue Plier, both have fine Diamond Dusted working tips. A perfect set for surgical and tunnelling procedures.



**Article# W19-487** Allen End-Cutting intrasulcular knife, DE

**Article# W19-488** 1/2 Allen Urban Knife, DE

**Article# W19-489** Tunneling instrument Knife n.2, DE

**Article# W19-490** Tunneling instrument Knife n.1, DE

**Article# W19-491** 11 Goldman-Fox Periodontal Knife, DE

**Article# W19-492** 7 Goldman-Fox Periodontal Knife, DE



**Article# W19-493** Scalpel Handle straight, for blades # 10 -15, 14.5 cm

**Article# W19-494** Micro Surgical Scalpel Handle, 13.5 cm



**Article# W19-495** Iris Scissors T.c Black Ceramic Coated 9cm



**Article# W19-496** Micro Cooley 18 cm



**Article# W19-497** Castroviejo Microsurgery Scissors 18cm



**Article# W19-498** Microsurgical Needle Holder Str 18cm

**Article# W19-499**  
DENTAL MICRO SURGERY Set of 12 Pcs  
with Cassette



**MICRO SURGERY SMALL KIT**

**DENTAL IMPLANT**



**Article# W19-500** Tunneling Knife #2 Lower Jaw/17.5cm



**Article# W19-501** Micro Papilla Elevator 1.5/2.0mm



**Article# W19-502** Periodontal Probe unc15/3A



**Article# W19-503** Orban Knife KO1-2



**Article# W19-504** Perio Elevator 15° Partial flap elevator



**Article# W19-505** Buser



**Article# W19-506**  
Blade Holder



**Article# W19-507**  
Micro Blade Holder



**Article# W19-508**  
Micro Corn Suture Pliers  
18cm



**Article# W19-509**  
Micro Tissue Plier  
Str DD 1mm 18cm



**Article# W19-510**  
Micro Multiple Teeth Tissue Plier  
Curved 18cm



**Article# W19-511**  
Micro Cooley Forceps  
18cm, 0.8mm



**Article# W19-512**  
Super Sharp Micro Scissors  
18cm



**Article# W19-513**  
Micro Surgery Small Set of 13 Pcs with Cassette Instruments  
Tray 20x14.5x3cm

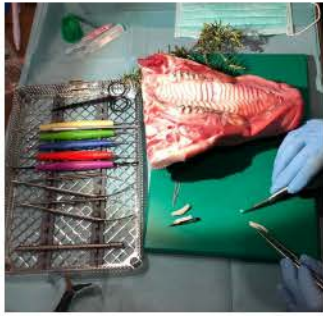

DENTAL MICRO SURGERY KIT

Article# WI9-514 Tunneling instrument # 0 double ended



Article# WI9-515 Tunneling instrument # 1 double ended



Article# WI9-516 Tunneling instrument # 2 double-ended



Article# WI9-517

Tunneling instrument combination, straight (1.8 mm wide)/angled (1.7 mm wide) double ended



Article# WI9-518

Tunneling instrument combination, straight (1.8 mm wide)/angled (1.7 mm wide) double ended



Article# WI9-519 Tunneling instrument # 3, 1.8 mm, bent at 45 ° to the 1-shaft

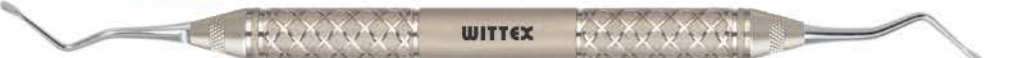

Article# WI9-520 Tunneling instrument # 4, 2.5 mm, bent at 45 ° to the 1-shaft



Article# WI9-521

Periodontal knife for the first access in tunneling technique in the anterior region, double-ended

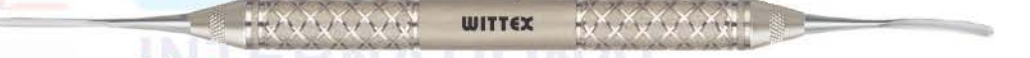

Article# WI9-522 Periodontal knife for tunneling technique in the posterior region.

With the slightly curved, tapered working ends can be dissected in the posterior region, double-ended



Article# WI9-523

Double angulation periodontal knife for access in hard to reach posterior areas, double-ended

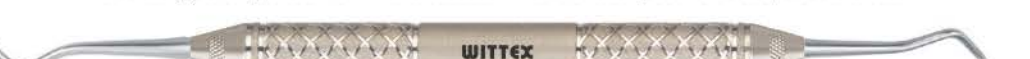

Article# WI9-524 For the preparation of split and full lobes, for later comb abutments or to cover recessions with a connective tissue graft.

The instruments allow a minimally invasive undermining preparation to avoid large swings



Article# WI9-525

Periodontal Curette / Double-ended 10/17

**Periotomes Implant Placement Titanium-Coated PDL Micro Serrated Tips Dental Instruments**  
 PERIOTOMES are used to cut periodontal ligaments for atraumatic tooth extractions and dental implant placement. They have sharp blades to facilitate the removal of teeth with minimal damage to surrounding alveolar bone.



**Article# W19-526/1** Scalpel Handle straight, for blades # 10 -15, 14.5 cm



**Article# W19-527/2** Micro Surgical Scalpel Handle, 13.5 cm



**Article# W19-528/3** Iris Scissors T.c Black Ceramic Coated 9cm



**Article# W19-529/4** Micro Cooley 18 cm



**Article# W19-530/5** Castroviejo Microsurgery Scissors 18cm



**Article# W19-531/6** Microsurgical Needle Holder Str 18cm

**Article# W19-532/7**  
DENTAL MICRO SURGERY Set of 18 Pcs  
with Cassette



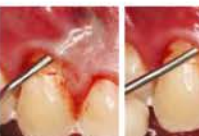



**DENTAL MICRO SURGERY KIT**

1.8mm **Article# WI9-533** Tunneling instrument # 0 double ended 1mm  

**WITTEX**

2mm **Article# WI9-534** Tunneling instrument # 1 double ended 1.6mm  

**WITTEX**

2.6mm **Article# WI9-535** Tunneling instrument # 2 double-ended 1.9mm  

**WITTEX**

**Article# WI9-536** Tunneling instrument combination, straight (1.8 mm wide)/angled (1.7 mm wide) double ended 1.7mm  

**WITTEX**

1.8mm **Article# WI9-537** Tunneling instrument combination, straight (1.8 mm wide)/angled (1.7 mm wide) double ended 1.6mm  

**WITTEX**

**Article# WI9-538** Tunneling instrument # 3, 1.8 mm, bent at 45 ° to the 1-shaft  

**WITTEX**

**Article# WI9-539** Tunneling instrument # 4, 2.5 mm, bent at 45 ° to the 1-shaft  

**WITTEX**

**Article# WI9-540**  
 Periodontal knife for the first access in tunneling technique in the anterior region, double-ended  

**WITTEX**

**Article# WI9-541** Periodontal knife for tunneling technique in the posterior region.  
 With the slightly curved, tapered working ends can be dissected in the posterior region, double-ended  

**WITTEX**

**Article# WI9-542**  
 Double angulation periodontal knife for access in hard to reach posterior areas, double-ended  

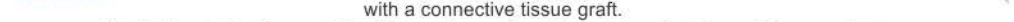
**WITTEX**

**Article# WI9-543** For the preparation of split and full lobes, for later comb abutments or to cover recessions with a connective tissue graft.  
 The instruments allow a minimally invasive undermining preparation to avoid large swings  

**WITTEX**

**Article# WI9-544**  
 Periodontal Curette / Double-ended 10/17  

**WITTEX**

**Periotomes Implant Placement Titanium-Coated PDL Micro Serrated Tips Dental Instruments**  
 PERIOTOMES are used to cut periodontal ligaments for atraumatic tooth extractions and dental implant placement. They have sharp blades to facilitate the removal of teeth with minimal damage to surrounding alveolar bone.



BASIC MICRO SURGERY KIT



Article# WI9-545 Tunnelling Knife TKN2



Article# WI9-546 Micro Papilla Elevator 1.5/2.0mm



Article# WI9-547 Micro Blade Holder



Article# WI9-548 Push Scalpel Blade Handle

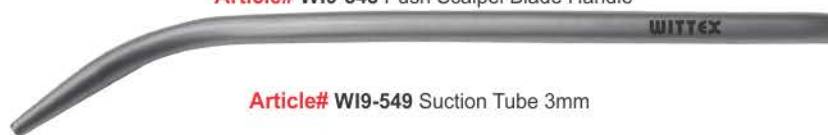

Article# WI9-549 Suction Tube 3mm



Article# WI9-550 Micro Suture Forcep 18cm, 1.2mm



Article# WI9-551 Micro Diamond Tweezers 18cm, 0.80mm, Suture size 6/0-8/0



Article# WI9-552 Micro Needle Holder 18cm, 0.6mm



Article# WI9-553 Micro Scissors 18cm



Article# WI9-554 Basic Micro Surgery Kit Set of 9 Pcs with Cassette Instruments Tray 20x14.5x3cm



DENTAL IMPLANT



- Оттисковые ложки
- Відбиткові ложки
- Porte-empreinte
- Cubetas para impresiones
- Abdrucklöffel
- صواني الانطباع

PERFORATED RIM LOCK UPPER



All the above impression trays are available in these 5 sizes

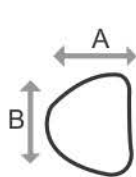

UPPER		U5	U4	U3	U2	U1
		XS	S	M	L	XL
A	A	52	53	54	60	62
	B	68	69	73	75	85

LOWER		L5	L4	L3	L2	L1
		XS	S	M	L	XL
A	A	52	53	54	60	62
	B	68	69	73	75	85

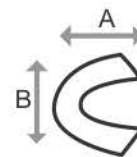

All Dimension are in mm

SOLID RIM LOCK UPPER



Оттисные ложки  
Porte-empainte  
Abdrucklöffel

Відбиткові ложки  
Cubetas para impresiones  
صواني الانطباع

PERFORATED FULL DENTURE UPPER

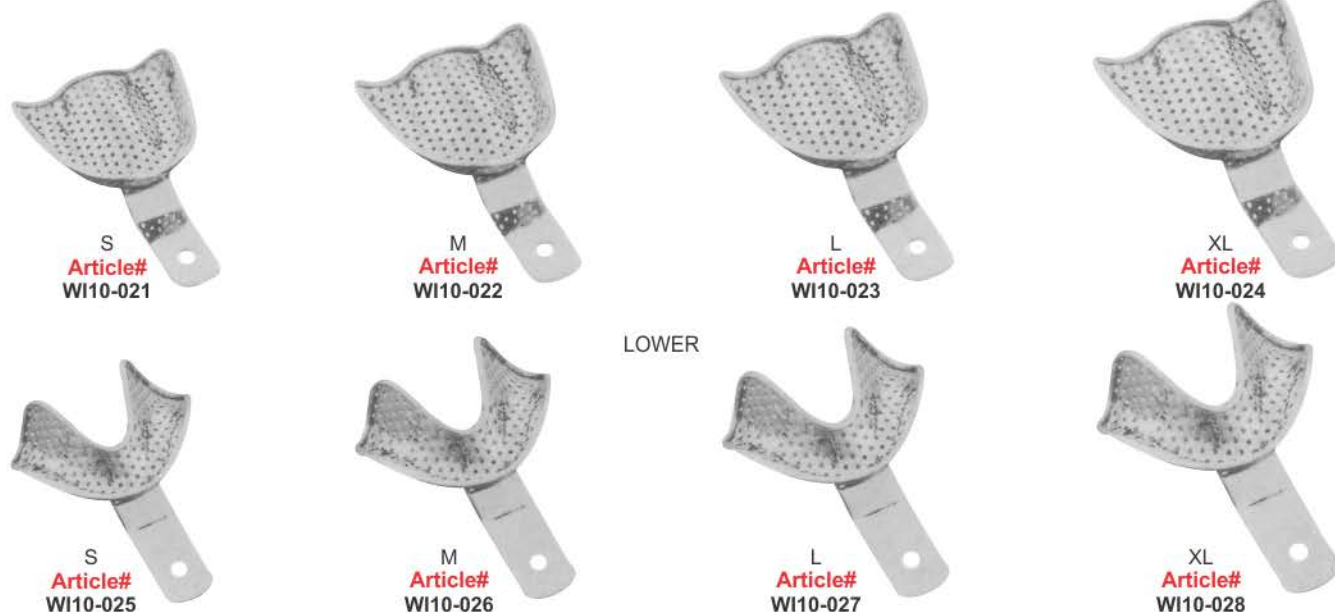

All the above impression trays are available in these 4 sizes

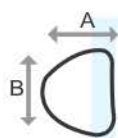

UPPER		S	M	L	XL
	A	60	64	67	70
B	70	73	76	79	

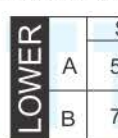

LOWER		S	M	L	XL
	A	57	60	60	64
B	70	70	73	86	

All Dimension are in mm

SOLID FULL DENTURE UPPER

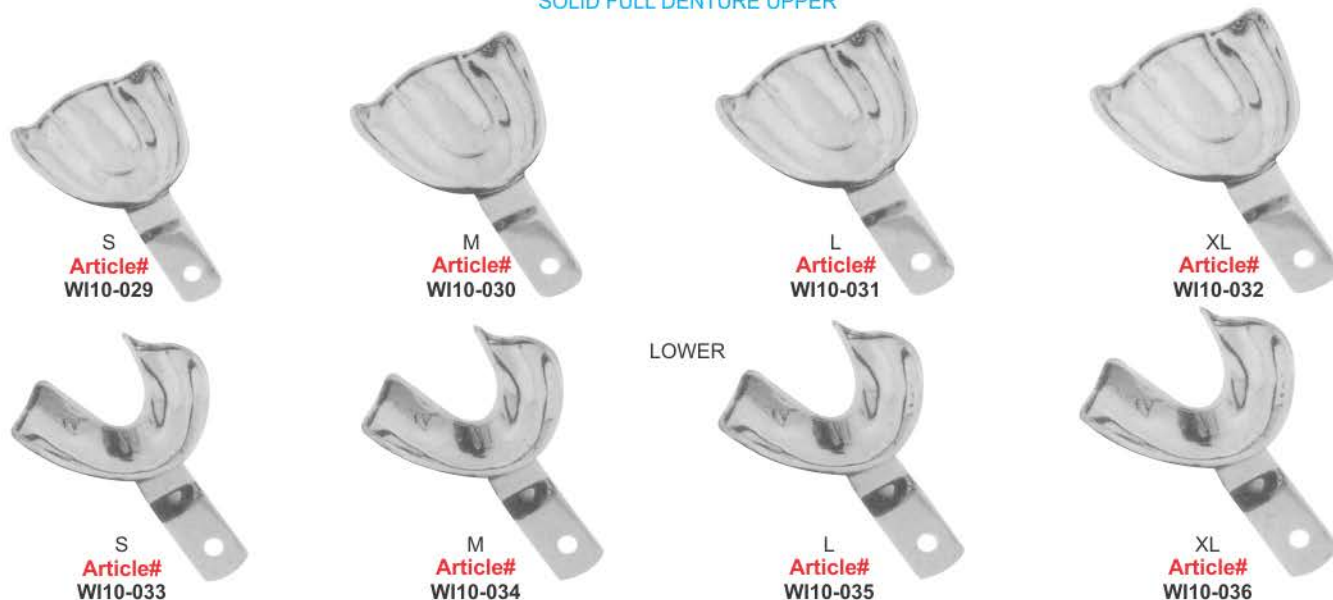

PERFORATED FULL DENTURE UPPER

SET OF 06 PCS  
Upper: S, M, L  
Lower: S, M, L  
Article# WI10-037

SET OF 08 PCS  
Upper: S, M, L, XL  
Lower: S, M, L, XL  
Article# WI10-038

SOLID FULL DENTURE UPPER

SET OF 06 PCS  
Upper: S, M, L  
Lower: S, M, L  
Article# WI10-039

SET OF 08 PCS  
Upper: S, M, L, XL  
Lower: S, M, L, XL  
Article# WI10-040

Оттисковые ложки  
Porte-empainte  
Abdrucklöffel

Відбиткові ложки  
Cubetas para impresiones  
صواني الانطباع

SOLID FULL DENTURE

UPPER



S  
Article#  
WI10-041



M  
Article#  
WI10-042



L  
Article#  
WI10-043



XL  
Article#  
WI10-044

LOWER



S  
Article#  
WI10-045



M  
Article#  
WI10-046



L  
Article#  
WI10-047



XL  
Article#  
WI10-048

SET OF 06 PCS

Upper: S, M, L  
Lower: S, M, L

Article# WI10-049

SET OF 08 PCS

Upper: S, M, L, XL  
Lower: S, M, L, XL

Article# WI10-050

All the above impression trays are available in these 4 sizes

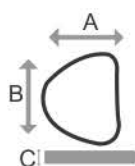

UPPER		S	M	L	XL
	A	60	64	67	70
B	70	73	76	79	

LOWER		S	S	M	L
	A	57	60	64	64
B	70	70	73	86	

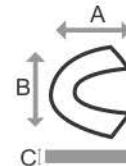

All Dimension are in mm

PERFORATED FULL DENTURE

UPPER



S  
Article#  
WI10-051



M  
Article#  
WI10-052



L  
Article#  
WI10-053



XL  
Article#  
WI10-054

LOWER



S  
Article#  
WI10-055



M  
Article#  
WI10-056  
SET OF 06 PCS  
Upper: S, M, L  
Lower: S, M, L  
Article# WI10-059



L  
Article#  
WI10-057



XL  
Article#  
WI10-058

SET OF 08 PCS  
Upper: S, M, L, XL  
Lower: S, M, L, XL  
Article# WI10-060

- Оттисковые ложки
- Відбиткові ложки
- Porte-empainte
- Cubetas para impresiones
- Abdrucklöffel
- صواني الانطباع

**UPPER**



**S**  
**Article#**  
**WI10-061**  
U3



**M**  
**Article#**  
**WI10-062**  
U2



**L**  
**Article#**  
**WI10-063**  
U1

**LOWER**



**S**  
**Article#**  
**WI10-064**  
L3



**M**  
**Article#**  
**WI10-065**  
L2



**L**  
**Article#**  
**WI10-066**  
L1

**SET OF 06 PCS**

Upper: S, M, L

Lower: S, M, L

**Article# WI10-067**

All the above impression trays are available in these 3 sizes

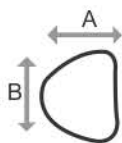

UPPER		U3	U2	U1	LOWER		L3	L2	L1
		S	M	L			S	M	L
	A	57	64	67		A	57	57	60
B	70	71	81	B	76	79	81		

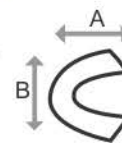

All Dimension are in mm

**UPPER**



**S**  
**Article#**  
**WI10-068**  
U3



**M**  
**Article#**  
**WI10-069**  
U2



**L**  
**Article#**  
**WI10-070**  
U1

**LOWER**



**S**  
**Article#**  
**WI10-071**  
L3



**M**  
**Article#**  
**WI10-072**  
L2



**L**  
**Article#**  
**WI10-073**  
L1

**SET OF 06 PCS**

Upper: S, M, L

Lower: S, M, L

**Article# WI10-074**

Оттисковые ложки  
Porte-empainte  
Abdrucklöffel

Відбиткові ложки  
Cubetas para impresiones  
صواني الانطباع

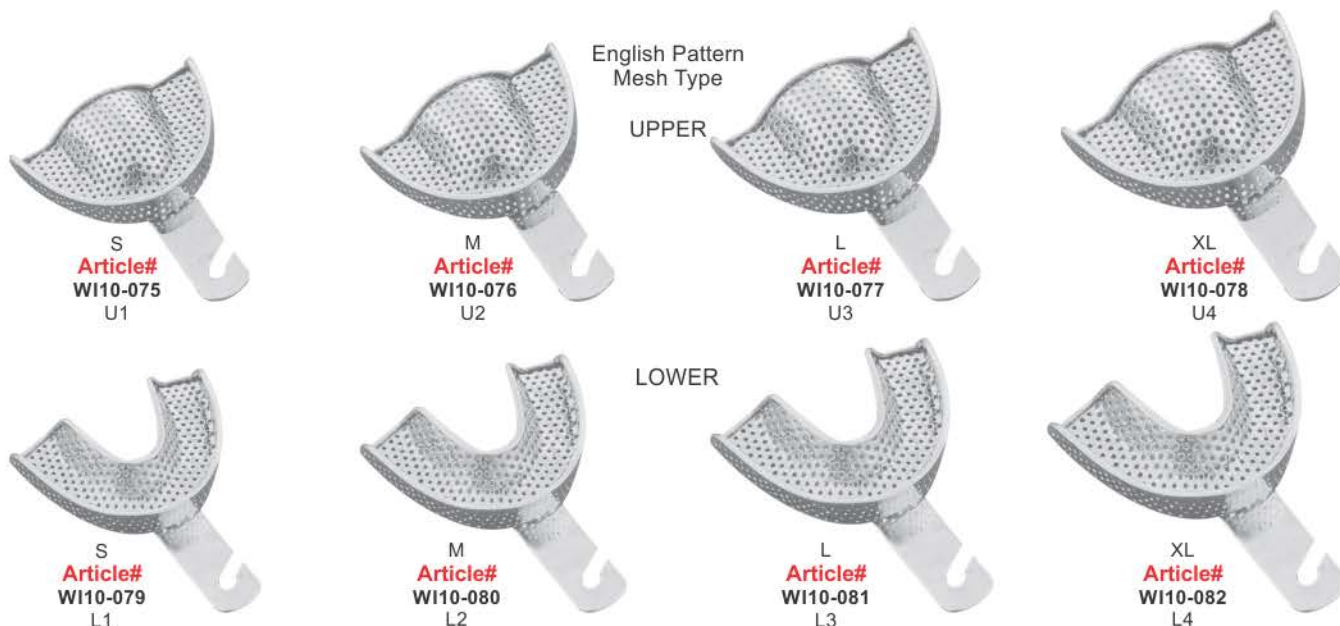

SET OF 06 PCS  
Upper: S, M, L  
Lower: S, M, L  
Article# W110-083

SET OF 08 PCS  
Upper: S, M, L, XL  
Lower: S, M, L, XL  
Article# W110-084

All the above impression trays are available in these 4 sizes

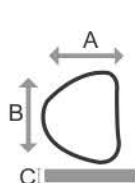

UPPER		U 1	U 2	U 3	U 4
		S	M	L	XL
	A	12	13	15	15
	B	50	51	55	58
	C	67	72	78	80

LOWER		L 1	L 2	L 3	L 4
		S	M	L	XL
	A	14	15	15	17
	B	50	51	55	60
	C	70	77	79	80

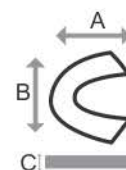

All Dimension are in mm

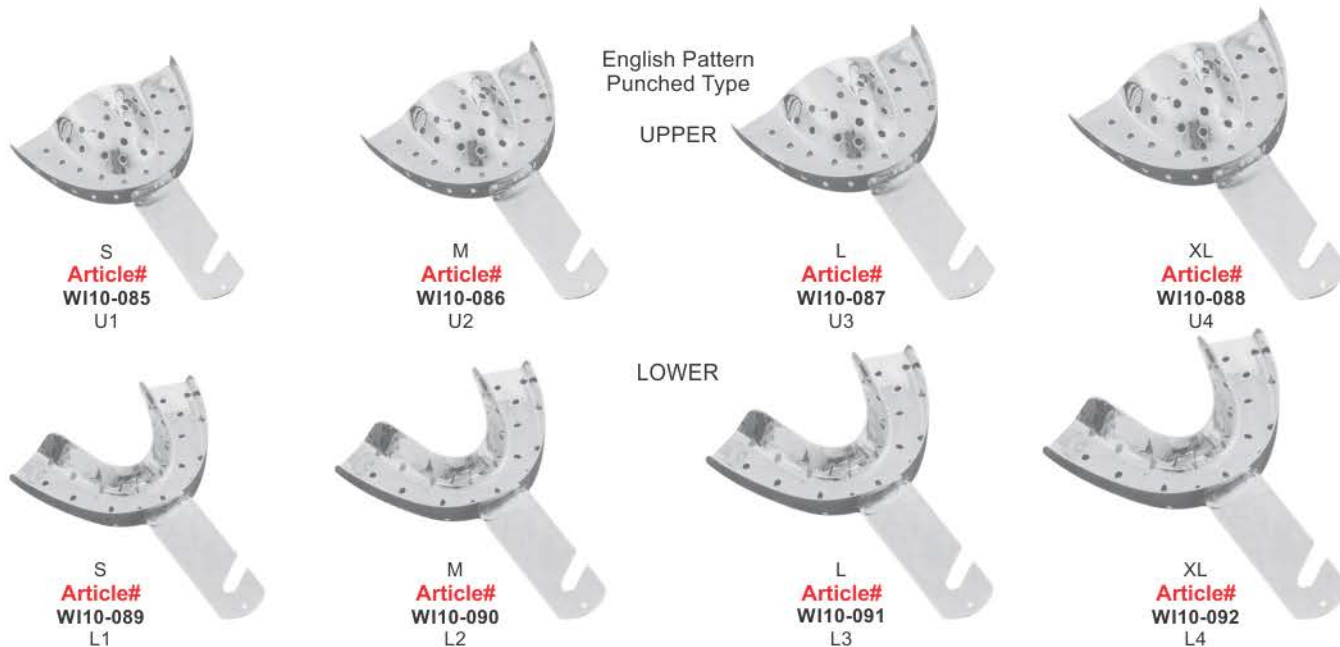

SET OF 06 PCS  
Upper: S, M, L  
Lower: S, M, L  
Article# W110-093

SET OF 08 PCS  
Upper: S, M, L, XL  
Lower: S, M, L, XL  
Article# W110-094

Оттисные ложки  
Porte-empainte  
Abdrucklöffel

Відбиткові ложки  
Cubetas para impresiones  
صواني الانطباع

**SOLID FULL DENTURE**

**UPPER**



S  
Article#  
WI10-095  
U1



M  
Article#  
WI10-096  
U2



L  
Article#  
WI10-097  
U3



XL  
Article#  
WI10-098  
U4

**LOWER**



S  
Article#  
WI10-099  
L1



M  
Article#  
WI10-100  
L2



L  
Article#  
WI10-101  
L3



XL  
Article#  
WI10-102  
L4

**SET OF 06 PCS**  
Upper: S, M, L  
Lower: S, M, L  
Article# WI10-103

**SET OF 08 PCS**  
Upper: S, M, L, XL  
Lower: S, M, L, XL  
Article# WI10-104

**PERFORATED FULL DENTURE**

**UPPER**



S  
Article#  
WI10-105  
U1



M  
Article#  
WI10-106  
U2



L  
Article#  
WI10-107  
U3



XL  
Article#  
WI10-108  
U4

**LOWER**



S  
Article#  
WI10-109  
L1



M  
Article#  
WI10-110  
L2



L  
Article#  
WI10-111  
L3



XL  
Article#  
WI10-112  
L4

**SET OF 06 PCS**  
Upper: S, M, L  
Lower: S, M, L  
Article# WI10-113

**SET OF 08 PCS**  
Upper: S, M, L, XL  
Lower: S, M, L, XL  
Article# WI10-114

- |                    |                            |
|--------------------|----------------------------|
| ■ Оттисковые ложки | ■ Відбиткові ложки         |
| ■ Porte-empainte   | ■ Cubetas para impresiones |
| ■ Abdrucklöffel    | ■ صواني الانطباع           |

**ORTHODONTIAL SOLID**

**UPPER**



S  
Article#  
WI10-115



M  
Article#  
WI10-116



L  
Article#  
WI10-117



XL  
Article#  
WI10-118

**LOWER**



S  
Article#  
WI10-119



M  
Article#  
WI10-120



L  
Article#  
WI10-121



XL  
Article#  
WI10-122

**SET OF 06 PCS**  
Upper: S, M, L  
Lower: S, M, L  
Article# WI10-123

**SET OF 08 PCS**  
Upper: S, M, L, XL  
Lower: S, M, L, XL  
Article# WI10-124

**ORTHODONTIAL PERFORATED**

**UPPER**



S  
Article# WI10-125



M  
Article# WI10-126



L  
Article# WI10-127



XL  
Article# WI10-128

**LOWER**



S  
Article# WI10-129



M  
Article# WI10-130



L  
Article# WI10-131



XL  
Article# WI10-132

**SET OF 06 PCS**  
Upper: S, M, L  
Lower: S, M, L  
Article# WI10-133

**SET OF 08 PCS**  
Upper: S, M, L, XL  
Lower: S, M, L, XL  
Article# WI10-134

- Оттисковые ложки
- Porte-empainte
- Abdrucklöffel
- Відбиткові ложки
- Cubetas para impresiones
- صواني الانطباع

**PERFORATED WITHOUT RIM LOCK**

**UPPER**



XXS  
**Article#**  
WI10-135  
U1

XS  
**Article#**  
WI10-136  
U2

S  
**Article#**  
WI10-137  
U3

M  
**Article#**  
WI10-138  
U4

L  
**Article#**  
WI10-139  
U5

XL  
**Article#**  
WI10-140  
U6

**LOWER**



XXS  
**Article#**  
WI10-141  
L1

XS  
**Article#**  
WI10-142  
L2

S  
**Article#**  
WI10-143  
L3

M  
**Article#**  
WI10-144  
L4

L  
**Article#**  
WI10-145  
L5

XL  
**Article#**  
WI10-146  
L6

**SET OF 06 PCS**  
Upper: S, M, L  
Lower: S, M, L  
**Article# WI10-147**

**SET OF 08 PCS**  
Upper: XS, S, M, L  
Lower: XS, S, M, L  
**Article# WI10-148**

**SET OF 08 PCS**  
Upper: S, M, L, XL  
Lower: S, M, L, XL  
**Article# WI10-149**

**SET OF 10 PCS**  
Upper: XS, S, M, L, XL  
Lower: XS, S, M, L, XL  
**Article# WI10-150**

**SET OF 12 PCS**  
Upper: XXS, XS, S, M, L, XL  
Lower: XXS, XS, S, M, L, XL  
**Article# WI10-151**

**SOLID WITHOUT RIM LOCK**

**UPPER**



XXS  
**Article#**  
WI10-152  
U1

XS  
**Article#**  
WI10-153  
U2

S  
**Article#**  
WI10-154  
U3

M  
**Article#**  
WI10-155  
U4

L  
**Article#**  
WI10-156  
U5

XL  
**Article#**  
WI10-157  
U6

**LOWER**



XXS  
**Article#**  
WI10-158  
L1

XS  
**Article#**  
WI10-159  
L2

S  
**Article#**  
WI10-160  
L3

M  
**Article#**  
WI10-161  
L4

L  
**Article#**  
WI10-162  
L5

XL  
**Article#**  
WI10-163  
L6

**SET OF 06 PCS**  
Upper: S, M, L  
Lower: S, M, L  
**Article# WI10-164**

**SET OF 08 PCS**  
Upper: XS, S, M, L  
Lower: XS, S, M, L  
**Article# WI10-165**

**SET OF 08 PCS**  
Upper: S, M, L, XL  
Lower: S, M, L, XL  
**Article# WI10-166**

**SET OF 10 PCS**  
Upper: XS, S, M, L, XL  
Lower: XS, S, M, L, XL  
**Article# WI10-167**

**SET OF 12 PCS**  
Upper: XXS, XS, S, M, L, XL  
Lower: XXS, XS, S, M, L, XL  
**Article# WI10-168**

All the above impression trays are available in these 6 sizes

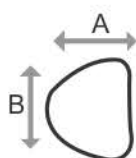

<b>UPPER</b>		U1	U2	U3	U4	U5	U6
		XXS	XS	S	M	L	XL
	A	61	64	66	69	71	73
	B	47	51	53	57	60	62

<b>LOWER</b>		L1	L2	L3	L4	L5	L6
		XXS	XS	S	M	L	XL
	A	55	60	72	74	76	78
	B	47	49	54	57	59	61

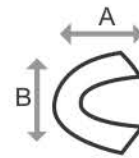

All Dimension are in mm

- |  |  |
|--|--|
|  Оттисные ложки |  Відбиткові ложки         |
|  Porte-empainte |  Cubetas para impresiones |
|  Abdrucklöffel  |  صواني الانطباع           |

**PARTIAL SOLID**



**Article#**  
WI10-169 44mm  
WI10-170 55mm  
WI10-171 60mm  
WI10-172 65mm



**Article#**  
WI10-173



**Article#**  
WI10-174 44mm  
WI10-175 55mm  
WI10-176 60mm  
WI10-177 65mm



**Article#**  
WI10-178



**Article#**  
WI10-179

Set of 5 Pcs **Article#** WI10-180

**PARTIAL PERFORATED**



**Article#**  
WI10-181 44mm  
WI10-182 55mm  
WI10-183 60mm  
WI10-184 65mm



**Article#**  
WI10-185



**Article#**  
WI10-186 44mm  
WI10-187 55mm  
WI10-188 60mm  
WI10-189 65mm



**Article#**  
WI10-190



**Article#**  
WI10-191



**Article#**  
WI10-192



**Article#**  
WI10-193

Set of 7 Pcs. **Article#** WI10-194

Оттисные ложки  
Porte-empreinte  
Abdrucklöffel

Відбиткові ложки  
Cubetas para impresiones  
صواني الانطباع



**XS**  
**Article#**  
W110-195  
U0



**S**  
**Article#**  
W110-196  
U1



**M**  
**Article#**  
W110-197  
U2

UPPER



**L**  
**Article#**  
W110-198  
U3



**XL**  
**Article#**  
W110-199  
U4

	A mm.	B mm.	UPPER
U 0	59	52	
U 1	66	52	
U 2	71	62	
U 3	71	64	
U 4	80	70	

IMPRESSION TRAYS



**XS**  
**Article#**  
W110-200  
L0



**S**  
**Article#**  
W110-201  
L1

LOWER



**M**  
**Article#**  
W110-202  
L2



**L**  
**Article#**  
W110-203  
L3



**XL**  
**Article#**  
W110-204  
L4

	A mm.	B mm.	LOWER
L 0	65	46	
L 1	67	50	
L 2	76	54	
L 3	79	56	
L 4	79	61	

**SET OF 10 PCS**  
Upper: XS, S, M, L, XL  
Lower: XS, S, M, L, XL  
**Article# W110-205**

Оттисные ложки  
Porte-empreinte  
Abdrucklöffel

Відбиткові ложки  
Cubetas para impresiones  
صواني الانطباع



**Article# W110-206**  
Impression Trays Set of 6 Pcs  
01 Impression Tray  
02 Impression Tray  
03 Impression Tray  
04 Impression Tray  
05 Impression Tray  
06 Impression Tray



**Article# W110-207**  
Impression Tray Set of 6 Pcs  
01 Impression Tray  
02 Impression Tray  
03 Impression Tray  
04 Impression Tray  
05 Impression Tray  
06 Impression Tray



**Article# W110-208**  
Impression Tray Set of 6 Pcs  
01 Impression Tray  
02 Impression Tray  
03 Impression Tray  
04 Impression Tray  
05 Impression Tray  
06 Impression Tray



**Article# W110-209**  
Perforated With Rim Lock  
SET OF 06 PCS  
Upper: S, M, L  
Lower: S, M, L



**Article# W110-210**  
Perforated With Rim Lock  
SET OF 10 PCS  
Upper: XS, S, M, L, XL  
Lower: XS, S, M, L, XL



**Article# W110-211**  
Partial Perforated Set of 5 Pcs.

■ Оттисные ложки  
■ Porte-empreinte  
■ Abdrucklöffel

■ Відбиткові ложки  
■ Cubetas para impresiones  
■ صواني الانطباع



Оттисные ложки  
Porte-empreinte  
Abdrucklöffel

Відбиткові ложки  
Cubetas para impresiones  
صواني الانطباع



**Scalers Tray**  
**Article#** WI11-001 200 x 100 mm



**Scalers Trays**  
**Article#**  
WI11-002 205 x 115 x 17 mm  
WI11-003 205 x 152 x 17 mm  
WI11-004 290 x 115 x 17 mm



**Instruments Trays**  
**Article#**  
WI11-005 200 x 110 x 30 mm  
WI11-006 215 x 115 x 35 mm  
WI11-007 220 x 130 x 30 mm  
WI11-008 230 x 125 x 35 mm  
WI11-009 245 x 140 x 40 mm  
WI11-010 285 x 160 x 45 mm  
WI11-011 315 x 175 x 50 mm  
WI11-012 330 x 185 x 50 mm



**Instruments Trays**  
**Article#**  
WI11-013 150 x 100 x 50 mm  
WI11-014 200 x 100 x 50 mm  
WI11-015 220 x 120 x 50 mm  
WI11-016 240 x 140 x 50 mm  
WI11-017 200 x 150 x 50 mm  
WI11-018 250 x 200 x 50 mm  
WI11-019 300 x 250 x 50 mm  
WI11-020 300 x 200 x 50 mm  
WI11-021 350 x 250 x 50 mm  
WI11-022 400 x 300 x 50 mm  
WI11-023 450 x 300 x 50 mm  
WI11-024 450 x 350 x 50 mm



**Instruments Trays With Lid**  
**Article#**  
WI11-025 150 x 100 x 50 mm  
WI11-026 200 x 100 x 50 mm  
WI11-027 220 x 120 x 50 mm  
WI11-028 240 x 140 x 50 mm  
WI11-029 200 x 150 x 50 mm  
WI11-030 250 x 200 x 50 mm  
WI11-031 300 x 250 x 50 mm  
WI11-032 300 x 200 x 50 mm  
WI11-033 350 x 250 x 50 mm  
WI11-034 400 x 300 x 50 mm  
WI11-035 450 x 300 x 50 mm  
WI11-036 450 x 350 x 50 mm



**Mayo Tray Perforated**  
**Article#**  
WI11-037 150 x 100 x 25 mm  
WI11-038 200 x 100 x 25 mm  
WI11-039 220 x 120 x 25 mm  
WI11-040 240 x 140 x 25 mm  
WI11-041 200 x 150 x 25 mm  
WI11-042 250 x 200 x 25 mm  
WI11-043 300 x 250 x 25 mm  
WI11-044 300 x 200 x 25 mm  
WI11-045 350 x 250 x 25 mm  
WI11-046 400 x 300 x 25 mm  
WI11-047 450 x 300 x 25 mm  
WI11-048 450 x 350 x 25 mm



**Scaler Tray**  
**Article#**  
WI11-049 200 x 115 mm  
WI11-050 205 x 150 mm  
WI11-051 290 x 150 mm  
WI11-052 300 x 200 mm



**Instruments Tray Perforated**  
**Article#**  
WI11-053 150 x 100 x 50 mm  
WI11-054 200 x 100 x 50 mm  
WI11-055 220 x 120 x 50 mm  
WI11-056 240 x 140 x 50 mm  
WI11-057 200 x 150 x 50 mm  
WI11-058 250 x 200 x 50 mm  
WI11-059 300 x 250 x 50 mm  
WI11-060 300 x 200 x 50 mm  
WI11-061 350 x 250 x 50 mm  
WI11-062 400 x 300 x 50 mm  
WI11-063 450 x 300 x 50 mm  
WI11-064 450 x 350 x 50 mm

- |                |                          |
|----------------|--------------------------|
| Оттисные ложки | Відбиткові ложки         |
| Porte-empainte | Cubetas para impresiones |
| Abdrucklöffel  | صواني الانطباع           |

### Sterilizing boxes & instruments Trays



**Instruments Box with Hooks**

**Article#**

- WI11-065 170 x 70 x 30 mm
- WI11-066 180 x 80 x 40 mm
- WI11-067 200 x 100 x 40 mm
- WI11-068 200 x 100 x 50 mm
- WI11-069 220 x 120 x 50 mm
- WI11-070 250 x 150 x 50 mm
- WI11-071 250 x 200 x 50 mm
- WI11-072 300 x 150 x 60 mm
- WI11-073 300 x 200 x 50 mm
- WI11-074 350 x 250 x 50 mm
- WI11-075 400 x 200 x 100 mm
- WI11-076 450 x 250 x 50 mm



**Instruments Box**

**Article#**

- WI11-077 170 x 70 x 30 mm
- WI11-078 180 x 80 x 40 mm
- WI11-079 200 x 100 x 40 mm
- WI11-080 200 x 100 x 50 mm
- WI11-081 220 x 120 x 50 mm
- WI11-082 250 x 150 x 50 mm
- WI11-083 250 x 200 x 50 mm
- WI11-084 300 x 150 x 60 mm
- WI11-085 300 x 200 x 50 mm
- WI11-086 350 x 250 x 50 mm
- WI11-087 400 x 200 x 100 mm
- WI11-088 450 x 250 x 50 mm



**Instruments Box Perforated**

**Article#**

- WI11-089 170 x 70 x 30 mm
- WI11-090 180 x 80 x 40 mm
- WI11-091 200 x 100 x 40 mm
- WI11-092 200 x 100 x 50 mm
- WI11-093 220 x 120 x 50 mm
- WI11-094 250 x 150 x 50 mm
- WI11-095 250 x 200 x 50 mm
- WI11-096 300 x 150 x 60 mm
- WI11-097 300 x 200 x 50 mm
- WI11-098 350 x 250 x 50 mm
- WI11-099 400 x 200 x 100 mm
- WI11-100 450 x 250 x 50 mm

HOLLOWARE INSTRUMENTS



**Gloves Box**

**Article#** WI11-101 300 x 150 mm



**Catheters Tray with lid**

**Article#**

- WI11-102 200 x 60 x 40 mm
- WI11-103 200 x 90 x 40 mm
- WI11-104 320 x 95 x 50 mm
- WI11-105 328 x 90 x 50 mm
- WI11-106 365 x 90 x 50 mm
- WI11-107 440 x 115 x 50 mm

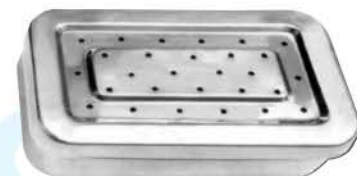

**Box With Filter**

**Article#**

- WI11-108 100 x 50 mm
- WI11-109 250 x 150 mm
- WI11-110 150 x 65 mm
- WI11-111 200 x 100 mm
- WI11-112 300 x 200 mm



**Instruments Trays With Cover**

**Article#**

- WI11-113 210 x 110 x 50 mm
- WI11-114 240 x 160 x 50 mm
- WI11-115 300 x 180 x 50 mm
- WI11-116 360 x 210 x 50 mm
- WI11-117 400 x 230 x 55 mm

**Instruments Trays Without Cover**

**Article#**

- WI11-118 210 x 110 x 50 mm
- WI11-119 240 x 160 x 50 mm
- WI11-120 300 x 180 x 50 mm
- WI11-121 360 x 210 x 50 mm
- WI11-122 400 x 230 x 55 mm



**Instruments Box with lid**

**Article#**

- WI11-123 170 x 70 x 30 mm
- WI11-124 180 x 80 x 40 mm
- WI11-125 200 x 100 x 40 mm
- WI11-126 200 x 100 x 50 mm
- WI11-127 220 x 120 x 50 mm
- WI11-128 250 x 150 x 50 mm
- WI11-129 250 x 200 x 50 mm
- WI11-130 300 x 150 x 60 mm
- WI11-131 300 x 200 x 50 mm
- WI11-132 350 x 250 x 50 mm
- WI11-133 400 x 200 x 100 mm
- WI11-134 450 x 250 x 50 mm

Оттисные ложки  
Porte-empreinte  
Abdrucklöffel

Відбиткові ложки  
Cubetas para impresiones  
صواني الانطباع



Kidney Tray

Article#

WI11-135 160 mm  
WI11-136 200 mm  
WI11-137 250 mm  
WI11-138 280 mm  
WI11-139 300 mm



Kidney Tray Shallow

Article#

WI11-140 170 mm  
WI11-141 220 mm  
WI11-142 240 mm



Kidney Tray With Cover

Article#

WI11-143 160 mm  
WI11-144 200 mm  
WI11-145 250 mm  
WI11-146 280 mm  
WI11-147 300 mm



Kidney Tray

Article#

WI11-148 160 mm  
WI11-149 200 mm  
WI11-150 250 mm  
WI11-151 280 mm  
WI11-152 300 mm



Forceps Jars

Article#

WI11-153 30 x 90 mm  
WI11-154 50 x 100 mm  
WI11-155 50 x 130 mm  
WI11-156 50 x 175 mm  
WI11-157 75 x 100 mm  
WI11-158 75 x 130 mm  
WI11-159 75 x 175 mm  
WI11-160 100 x 175 mm  
WI11-161 100 x 200 mm



Methot Jar Without Lid

Article# WI11-162



Dressing Jar / Cotton Container

Article#

WI11-163 80 x 80 mm  
WI11-164 100 x 60 mm  
WI11-165 100 x 80 mm  
WI11-166 100 x 100 mm  
WI11-167 120 x 80 mm  
WI11-168 120 x 100 mm  
WI11-169 150 x 100 mm  
WI11-170 150 x 150 mm  
WI11-171 180 x 150 mm  
WI11-172 180 x 180 mm  
WI11-173 200 x 200 mm  
WI11-174 240 x 240 mm



Sputum Cup  
WI11-175



Dressing Jar With Lid & Knob

Article#

WI11-176 80 x 80 mm  
WI11-177 90 x 90 mm  
WI11-178 100 x 100 mm  
WI11-179 120 x 120 mm  
WI11-180 100 x 130 mm  
WI11-181 150 x 150 mm  
WI11-182 125 x 170 mm



Round Bowls

Article#

WI11-183 80 x 35 mm  
WI11-184 125 x 60 mm

Оттисковые ложки  
Porte-empreinte  
Abdrucklöffel

Відбиткові ложки  
Cubetas para impresiones  
صواني الانطباع



**Article#**  
**WI11-185**

mm 200 x 90  
Kidney bowls  
Bacinella reniforme

**Article#**  
**WI11-186**

mm 300 x 140  
Kidney bowls  
Bacinella reniforme



**Article#**

**WI11-187 CL**  
mm 200 x 90  
Cover for kidney bowl  
Coperchio per bacinella  
reniforme



**Article#**

**WI11-188 CL**  
mm 200 x 90  
Cover for kidney bowl  
Coperchio per bacinella  
reniforme



**Article#**

**WI11-189**  
ø mm 80 inox



**Article#**

**WI11-190**  
ø mm 60 inox



**Round Bowls With Cover**

**Article#**

**WI11-193** Ø 40 mm ml.30  
**WI11-194** Ø 60 mm ml.50  
**WI11-195** Ø 80 mm ml.150  
**WI11-196** Ø 100 mm ml.250  
**WI11-197** Ø 120 mm ml.450  
**WI11-198** Ø 150 mm ml.750  
**WI11-199** Ø 180 mm ml.1500  
**WI11-200** Ø 200 mm ml.2100  
**WI11-201** Ø 250 mm ml.3500

**Round Bowls With Out Cover**

**Article#**

**WI11-202** Ø 40 mm ml.30  
**WI11-203** Ø 60 mm ml.50  
**WI11-204** Ø 80 mm ml.150  
**WI11-205** Ø 100 mm ml.250  
**WI11-206** Ø 120 mm ml.450  
**WI11-207** Ø 150 mm ml.750  
**WI11-208** Ø 180 mm ml.1500  
**WI11-209** Ø 200 mm ml.2100  
**WI11-210** Ø 250 mm ml.3500



**Article#** **WI11-191**

Aluminium endodontic tray complete with lid.  
Dimensions mm 257 x 116 x 16.  
Vassoio per endodonzia in alluminio anodizzato completo  
di coperchio. Dimensioni mm 284 x 187 x 16.



**Article#**

**WI11-192**  
ø mm 30 inox



**Article#** **WI11-211**

mm 300 x 200 x 50



**Article#** **WI11-212**

mm 200 x 150 x 40



**Article#** **WI11-213**

mm 210 x 160 x 25

**STERILIZATION DRUMS**



**Round Sterilizer Drum**

**Article#**

WI11-214	mm. Ø 80 x 80 H
WI11-215	mm. Ø 125 x 80 H
WI11-216	mm. Ø 125 x 100 H
WI11-217	mm. Ø 125 x 125 H
WI11-218	mm. Ø 150 x 80 H
WI11-219	mm. Ø 150 x 100 H
WI11-220	mm. Ø 150 x 130 H
WI11-221	mm. Ø 150 x 150 H
WI11-222	mm. Ø 150 x 190 H
WI11-223	mm. Ø 190 x 125 H
WI11-224	mm. Ø 190 x 145 H
WI11-225	mm. Ø 190 x 165 H
WI11-226	mm. Ø 190 x 190 H
WI11-227	mm. Ø 190 x 240 H
WI11-228	mm. Ø 190 x 290 H
WI11-229	mm. Ø 240 x 120 H
WI11-230	mm. Ø 240 x 145 H
WI11-231	mm. Ø 240 x 165 H
WI11-232	mm. Ø 240 x 190 H
WI11-233	mm. Ø 240 x 240 H
WI11-234	mm. Ø 240 x 290 H
WI11-235	mm. Ø 240 x 340 H
WI11-236	mm. Ø 240 x 390 H
WI11-237	mm. Ø 290 x 145 H
WI11-238	mm. Ø 290 x 165 H
WI11-239	mm. Ø 290 x 190 H
WI11-240	mm. Ø 290 x 240 H
WI11-241	mm. Ø 290 x 290 H
WI11-242	mm. Ø 290 x 340 H
WI11-243	mm. Ø 290 x 390 H
WI11-244	mm. Ø 340 x 145 H
WI11-245	mm. Ø 340 x 165 H
WI11-246	mm. Ø 340 x 190 H
WI11-247	mm. Ø 340 x 240 H
WI11-248	mm. Ø 340 x 290 H
WI11-249	mm. Ø 340 x 340 H
WI11-250	mm. Ø 340 x 390 H
WI11-251	mm. Ø 390 x 140 H
WI11-252	mm. Ø 390 x 165 H
WI11-253	mm. Ø 390 x 190 H
WI11-254	mm. Ø 390 x 240 H
WI11-255	mm. Ø 390 x 290 H
WI11-256	mm. Ø 390 x 340 H
WI11-257	mm. Ø 390 x 390 H
WI11-258	mm. Ø 390 x 490 H

**Round Sterilizer Drums "Filter"**

**Article#**

WI11-259	mm. Ø 80 x 80 H
WI11-260	mm. Ø 125 x 80 H
WI11-261	mm. Ø 125 x 100 H
WI11-262	mm. Ø 125 x 125 H
WI11-263	mm. Ø 150 x 100 H
WI11-264	mm. Ø 150 x 130 H
WI11-265	mm. Ø 150 x 150 H
WI11-266	mm. Ø 150 x 190 H
WI11-267	mm. Ø 190 x 145 H
WI11-268	mm. Ø 190 x 165 H
WI11-269	mm. Ø 190 x 190 H
WI11-270	mm. Ø 190 x 240 H
WI11-271	mm. Ø 240 x 145 H
WI11-272	mm. Ø 240 x 165 H
WI11-273	mm. Ø 240 x 190 H
WI11-274	mm. Ø 240 x 240 H
WI11-275	mm. Ø 240 x 290 H
WI11-276	mm. Ø 240 x 340 H
WI11-277	mm. Ø 240 x 390 H
WI11-278	mm. Ø 290 x 145 H
WI11-279	mm. Ø 290 x 165 H
WI11-280	mm. Ø 290 x 190 H
WI11-281	mm. Ø 290 x 240 H
WI11-282	mm. Ø 290 x 290 H
WI11-283	mm. Ø 290 x 340 H
WI11-284	mm. Ø 290 x 390 H
WI11-285	mm. Ø 340 x 145 H
WI11-286	mm. Ø 340 x 165 H
WI11-287	mm. Ø 340 x 190 H
WI11-288	mm. Ø 340 x 240 H
WI11-289	mm. Ø 340 x 290 H
WI11-290	mm. Ø 390 x 140 H
WI11-291	mm. Ø 390 x 165 H
WI11-292	mm. Ø 390 x 190 H
WI11-293	mm. Ø 390 x 240 H
WI11-294	mm. Ø 390 x 290 H
WI11-295	mm. Ø 390 x 340 H
WI11-296	mm. Ø 390 x 490 H

**Article#**

**WI11-297/0**  
ø mm 190 x 160  
Inox



**Article#**

**WI11-298/1**  
ø mm 160 x 140  
Inox



**Article#**

**WI11-299/2**  
ø mm 120 x 120  
Inox



**Article#**

**WI11-300/3**  
ø mm 100 x 120  
Inox

Оттисные ложки  
Porte-empainte  
Abdrucklöffel

Відбиткові ложки  
Cubetas para impresiones  
صواني الانطباع



**Article#**  
**WI11-301 C**  
mm 284 x 187 x 29  
Lid  
Coperchio

**Article#**  
**WI11-302 V**  
mm 284 x 187 x 29  
Tray  
Vassoio



**Article#**  
**WI11-303 CF**  
mm 284 x 187 x 29  
Perforated lid  
Coperchio forato

**Article#**  
**WI11-304 VF**  
mm 284 x 187 x 29  
Perforated tray  
Vassoio forato



**Article#**  
**WI11-305 FC MINI**  
mm 187 x 145 x 25  
Perforated lid  
Coperchio forato

**Article#**  
**WI11-306 FV MINI**  
mm 183 x 140 x 17  
Perforated tray  
Vassoio forato



**Article#**  
**WI11-307 C MINI**  
mm 187 x 145 x 25  
Lid  
Coperchio

**Article#**  
**WI11-308 V MINI**  
mm 183 x 140 x 17  
Tray  
Vassoio



**Article#**  
**WI11-309**  
N. 23 pcs  
Stainless steel  
Acciaio inox

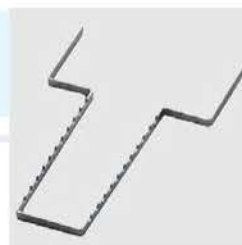

**Article#**  
**WI11-310 A**  
N. 17 pcs  
Aluminium  
Alluminio



**Article#**  
**WI11-313**  
N. 16 pcs  
Stainless steel  
Acciaio inox

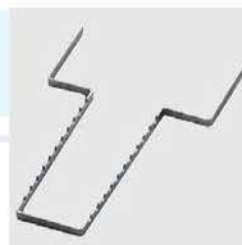

**Article#**  
**WI11-311**  
N. 16 pcs  
Stainless steel  
Acciaio inox



**Article#**  
**WI11-312 A**  
N. 11 pcs  
Aluminium  
Alluminio

**Article#**  
**WI11-314 A**  
Small N. 8 pcs  
Aluminium  
Alluminio



**Article#** **WI11-315 A**  
mm 284 x 187 x 29  
Lid - Normal size  
Coperchio - Standard

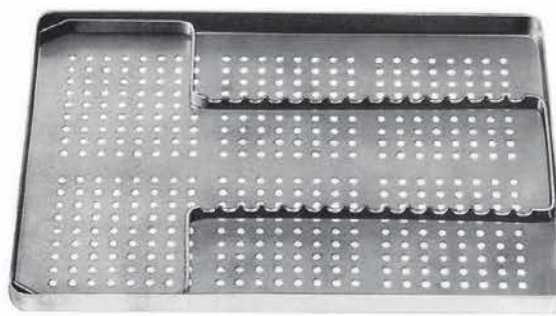

**Article#** **WI11-316 AS MINI**  
mm 187 x 145 x 25  
Lid - Small size  
Coperchio - Midi

**Article#**  
**WI11-317 FA**  
mm 284 x 183 x 17  
Perforated tray  
Assorted colors  
Normal size  
Vassoio forato  
Colori assortiti  
Standard

**Article#**  
**WI11-318 FAS MINI**  
mm 183 x 140 x 17  
Perforated tray  
Assorted colors  
Small size  
Vassoio forato  
Colori assortiti  
Midi

- |  |  |
|--|--|
|  Оттисные ложки |  Відбиткові ложки         |
|  Porte-empainte |  Cubetas para impresiones |
|  Abdrucklöffel  |  صواني الانطباع           |



Spirit Lamp  
Article# WI11-319



Spirit Lamp  
Article# WI11-320



Spirit Lamp  
Article# WI11-321



68 x 60 x 20mm



110 x 75 x 5mm



65 x 30mm



Cotton Holding Jar  
Article# WI11-322



Cotton Holder  
Article# WI11-323



Cotton Wool Dispenser Acc.  
to Methot  
Article# WI11-324



Needle Sterillization Tub  
Article# WI11-325



Round Endodontic Boxes  
complete with lid  
Article# WI11-326 Ø mm. 94 - h. mm. 70



Endodontic Box  
Article# WI11-327

Оттисные ложки  
Porte-empreinte  
Abdrucklöffel

Відбиткові ложки  
Cubetas para impresiones  
صواني الانطباع

Stainless steel trays with locking instruments in silicon, resistant to corrosion. Ssi trays are simple to use and improve the protection and the storage of your valuables instruments. Maximize the efficiency and performance of washing and sterilization.

Stainless Steel Safety Lock



Article# WI11-328  
mm 288 x 182 x 35  
20 instruments

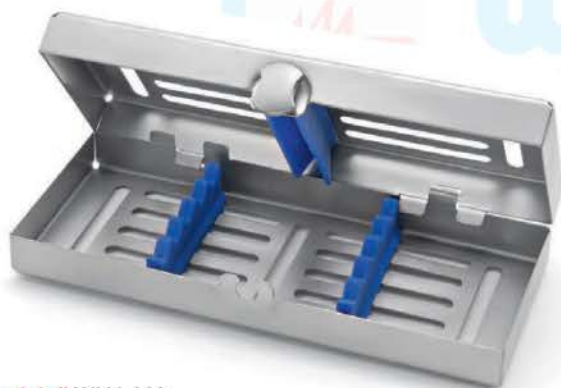

Article# WI11-329  
mm 182 x 72 x 35  
5 instruments



Article# WI11-331  
mm 182 x 145 x 35  
10 instruments



Article# WI11-330  
mm 180 x 85 x 15  
5 instruments

Оттисковые ложки  
Porte-empainte  
Abdrucklöffel

Відбиткові ложки  
Cubetas para impresiones  
صواني الانطباع



Article#  
WI11-332  
For Professional



Article#  
WI11-333  
For Student



Article#  
WI11-334 09 - Holes  
WI11-335 12 - Holes



Article#  
WI11-336  
12 - Holes

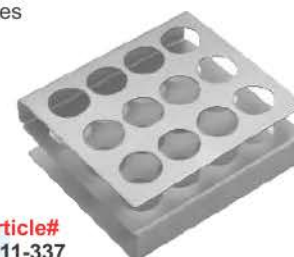

Article#  
WI11-337  
12 - Holes



Article# WI11-338  
170 x 75 x 23mm  
cassette for soft brushing kit



Cassette for 7 - Instruments  
L W H  
Article# 220 125 25  
WI11-339



Cassette for PRF Instruments  
L W H  
Article# 220 200 34  
WI11-340



Goldman fox Scissors TC, 13cm  
1 x 2 teeth 12.5cm

Prf Tweezer 16cm

**HOLLOWARE  
SECTION 11**

■ Оттисные ложки  
■ Porte-empainte  
■ Abdrucklöffel

■ Відбиткові ложки  
■ Cubetas para impresiones  
■ صواني الانطباع

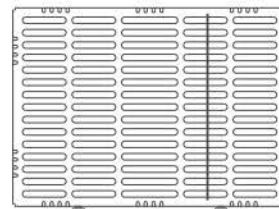
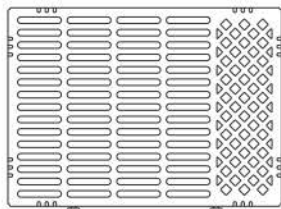

Article#	L	W	H		
WI11-341	202	130	32	05 plus instruments	05 instruments + accessory area
WI11-342	202	140	32	08 plus instruments	08 instruments + accessory area
WI11-343	202	195	32	10 plus instruments	10 instruments + accessory area
WI11-344	267	165	32	12 plus instruments	12 instruments + accessory area
WI11-345	280	202	32	15 plus instruments	15 instruments + accessory area
WI11-346	280	202	32	16 plus instruments	16 instruments + accessory area
WI11-347	370	202	32	14 plus instruments	4 Elevator+10 instruments + accessory area
WI11-348	370	202	32	20 plus instruments	20 instruments + accessory area

Article#	L	W	H		
WI11-349	202	130	32	05 plus instruments	05 instruments + accessory area
WI11-350	202	140	32	08 plus instruments	08 instruments + accessory area
WI11-351	202	195	32	10 plus instruments	10 instruments + accessory area
WI11-352	267	165	32	12 plus instruments	12 instruments + accessory area
WI11-353	280	202	32	15 plus instruments	15 instruments + accessory area
WI11-354	280	202	32	16 plus instruments	16 instruments + accessory area
WI11-355	370	202	32	14 plus instruments	4 Elevator + 10 instruments + accessory area
WI11-356	370	202	32	20 plus instruments	20 instruments + accessory area

**TWIN CASSETTE**

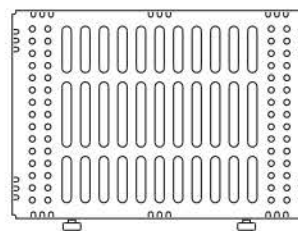
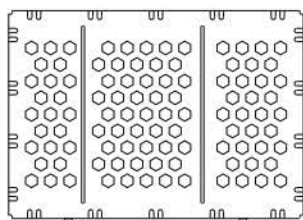
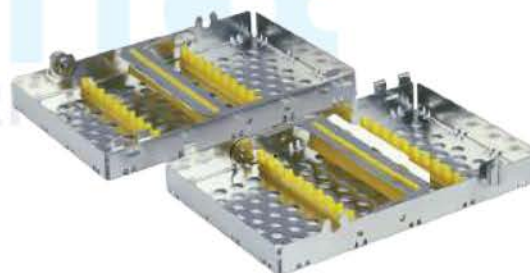

Also available with Hinges

Also available with Detachable

Article#	L	W	H		
WI11-357	200	85	44	10 instruments	Detachable
WI11-358	200	140	44	20 instruments	Detachable

Article#	L	W	H		
WI11-359	200	85	44	10 instruments	Detachable
WI11-360	200	140	44	20 instruments	Detachable



Article#	L	W	H		
WI11-361	200	182	34		For Osteotome Set
WI11-362	200	200	34		For Osteotome Set with hammer



Оттисковые ложки  
Porte-empainte  
Abdrucklöffel

Відбиткові ложки  
Cubetas para impresiones  
صواني الانطباع

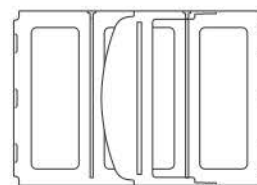
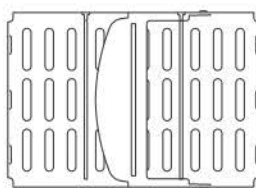
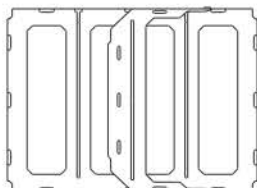
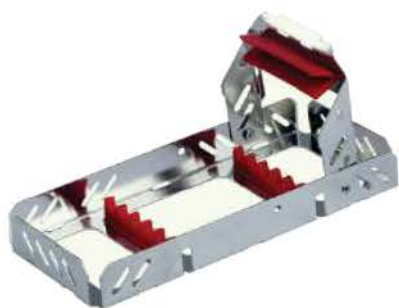

Article#	L	W	H	
WI11-363	180	82	23	05 - instruments
WI11-364	180	105	23	07 - instruments
WI11-365	180	135	23	10 - instruments
WI11-366	265	180	23	20 - instruments

Article#	L	W	H	
WI11-367	190	70	23	05 - instruments
WI11-368	190	96	23	07 - instruments
WI11-369	190	132	23	10 - instruments
WI11-370	265	190	23	20 - instruments

Article#	L	W	H	
WI11-371	190	82	23	05 - instruments
WI11-372	190	105	23	07 - instruments
WI11-373	190	135	23	10 - instruments
WI11-374	265	190	23	20 - instruments

**CASSETTE TRAYS STRIP LOCK**

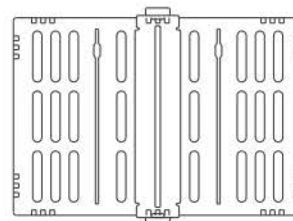
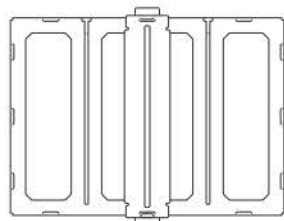

Article#	L	W	H	
WI11-375	180	80	22	05 - instruments
WI11-376	180	105	22	07 - instruments
WI11-377	180	132	22	10 - instruments
WI11-378	260	180	22	20 - instruments

Article#	L	W	H	
WI11-379	180	80	22	05 - instruments
WI11-380	180	105	22	07 - instruments
WI11-381	180	130	22	10 - instruments
WI11-382	260	180	22	20 - instruments

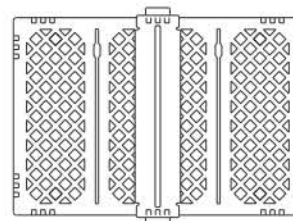
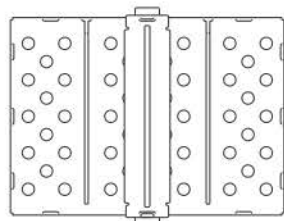

Article#	L	W	H	
WI11-383	180	80	22	05 - instruments
WI11-384	180	105	22	07 - instruments
WI11-385	180	130	22	10 - instruments
WI11-386	260	180	22	20 - instruments

Article#	L	W	H	
WI11-387	180	80	22	05 - instruments
WI11-388	180	105	22	07 - instruments
WI11-389	180	130	22	10 - instruments
WI11-390	260	180	22	20 - instruments

**HOLLOWWARE  
SECTION 11**

- Оттискные ложки
- Porte-empreinte
- Abdrucklöffel
- Відбиткові ложки
- Cubetas para impresiones
- صواني الانطباع

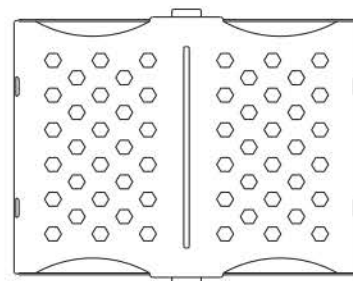
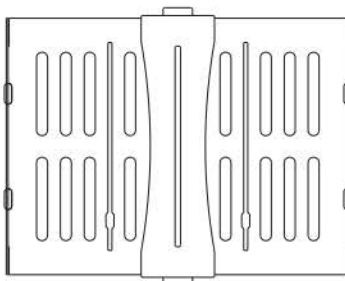
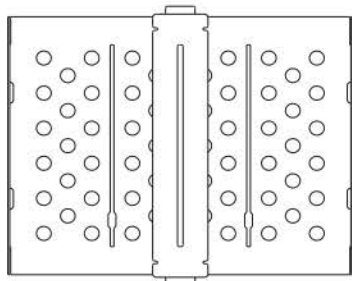

Article#	L	W	H	
WI11-391	185	90	23	05 - instruments
WI11-392	185	112	23	07 - instruments
WI11-393	185	145	23	10 - instruments
WI11-394	265	185	23	20 - instruments

Article#	L	W	H	
WI11-395	185	90	23	05 - instruments
WI11-396	185	112	23	07 - instruments
WI11-397	185	145	23	10 - instruments
WI11-398	265	185	23	20 - instruments

Article#	L	W	H	
WI11-399	185	90	23	05 - instruments
WI11-400	185	112	23	07 - instruments
WI11-401	185	145	23	10 - instruments
WI11-402	265	185	23	20 - instruments

HOLLOWWARE INSTRUMENTS

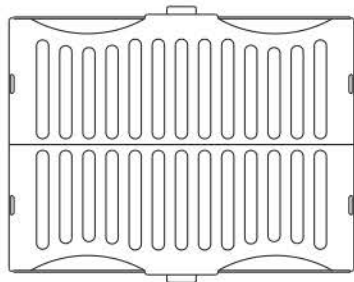

Article#	L	W	H	
WI11-403	185	90	23	05 - instruments
WI11-404	185	112	23	07 - instruments
WI11-405	185	145	23	10 - instruments
WI11-406	265	185	23	20 - instruments

**CASSETTE TRAYS SQUARE**

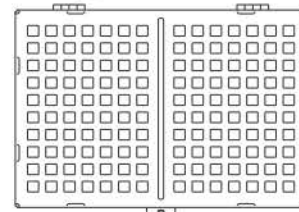

Article#	L	W	H	
WI11-407	180	70	22	05 - instruments
WI11-408	180	95	22	07 - instruments
WI11-409	180	130	22	10 - instruments
WI11-410	260	180	22	20 - instruments

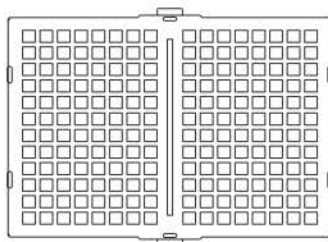

Article#	L	W	H	
WI11-411	185	90	24	05 - instruments
WI11-412	185	112	24	07 - instruments
WI11-413	185	145	24	10 - instruments
WI11-414	265	185	24	20 - instruments

HOLLOWWARE SECTION 11

Оттисные ложки  
Porte-empainte  
Abdrucklöffel

Відбиткові ложки  
Cubetas para impresiones  
صواني الانطباع

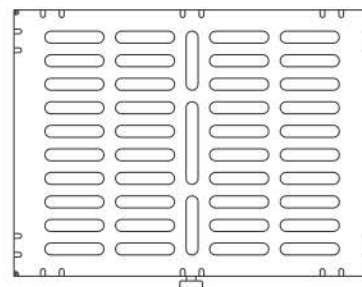

Article#	L	W	H	
WI11-415	190	76	30	05 - instruments
WI11-416	190	102	30	07 - instruments
WI11-417	190	115	30	08 - instruments
WI11-418	190	142	30	10 - instruments
WI11-419	270	190	30	20 - instruments
WI11-420	280	202	30	20 - instruments



WITTEX INTERNATIONAL

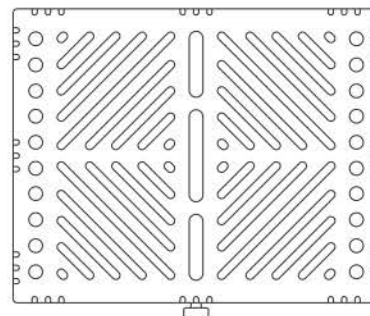

Article#	L	W	H	
WI11-421	200	80	35	05 - instruments
WI11-422	200	105	35	07 - instruments
WI11-423	200	145	35	10 - instruments
WI11-424	200	208	35	15 - instruments
WI11-425	280	200	35	20 - instruments



HOLLOWWARE INSTRUMENTS

**HOLLOWARE  
SECTION 11**

■ Оттисные ложки  
■ Porte-empainte  
■ Abdrucklöffel

■ Відбиткові ложки  
■ Cubetas para impresiones  
■ صواني الانطباع

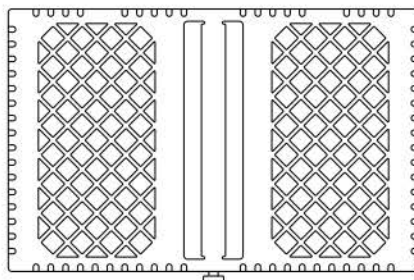

HOLLOWARE INSTRUMENTS



Article#	L	W	H	
WI11-426	222	95	22	05 - instruments
WI11-427	222	110	22	06 - instruments
WI11-428	222	126	22	07 - instruments
WI11-429	222	142	22	08 - instruments
WI11-430	222	174	22	10 - instruments
WI11-431	222	205	22	12 - instruments
WI11-432	268	202	30	12 - instruments Plus
WI11-433	370	230	32	20 - instruments Plus

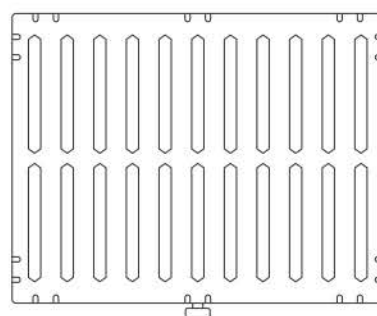

Article#	L	W	H	
WI11-434	182	78	32	05 - instruments
WI11-435	182	102	32	07 - instruments
WI11-436	182	142	32	10 - instruments
WI11-437	270	182	32	20 - instruments



HOLLOWARE SECTION 11

Оттисные ложки  
Porte-empainte  
Abdrucklöffel

Відбиткові ложки  
Cubetas para impresiones  
صواني الانطباع

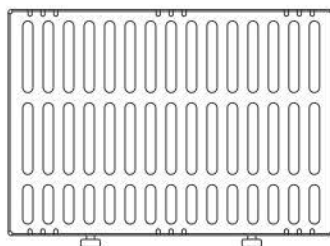

Article#	L	W	H	
WI11-438	203	50	32	03 - instruments
WI11-439	203	76	32	05 - instruments
WI11-440	203	102	32	07 - instruments
WI11-441	203	142	32	08 - instruments + accessory area
WI11-442	203	142	32	10 - instruments
WI11-443	265	165	32	12 - instruments + accessory area
WI11-444	280	202	30	20 - instruments + accessory area



CASSETTE TRAYS ELONGATED

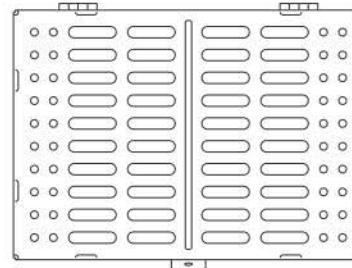
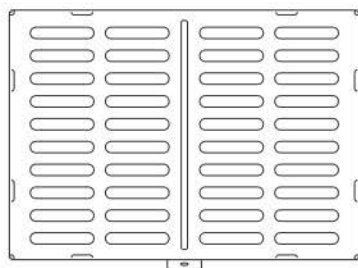

Article#	L	W	H	
WI11-445	180	55	23	03 - instruments
WI11-446	180	70	23	05 - instruments
WI11-447	180	95	23	07 - instruments
WI11-448	180	130	23	10 - instruments
WI11-449	260	180	23	20 - instruments

Article#	L	W	H	
WI11-450	190	55	23	03 - instruments
WI11-451	190	70	23	05 - instruments
WI11-452	190	95	23	07 - instruments
WI11-453	190	130	23	10 - instruments
WI11-454	260	190	23	20 - instruments

HOLLOWARE INSTRUMENTS

■ Оттисные ложки  
■ Porte-empainte  
■ Abdrucklöffel

■ Відбиткові ложки  
■ Cubetas para impresiones  
■ صواني الانطباع



Article#	L	W	H	
WI11-455	185	70	22	05 - instruments
WI11-456	188	95	22	07 - instruments
WI11-457	185	130	22	10 - instruments
WI11-458	260	185	22	20 - instruments



Article#	L	W	H	
WI11-459	185	80	23	05 - instruments
WI11-460	185	100	23	07 - instruments
WI11-461	185	135	23	10 - instruments
WI11-462	275	185	23	20 - instruments

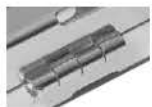

HOLLOWARE INSTRUMENTS

**DOUBLE HINGE CASSETTE TRAYS**

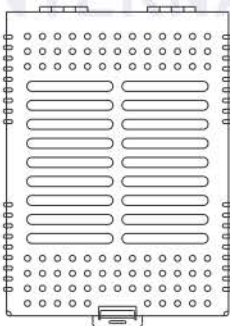

Article#	L	W	H	
WI11-463	202	82	34	05 - instruments
WI11-464	202	90	34	06 - instruments
WI11-465	202	104	34	07 - instruments
WI11-466	202	142	34	10 - instruments
WI11-467	275	202	34	15 - instruments + accessory area
WI11-468	300	202	34	16 - instruments + accessory area



Cassette tray Suitable for  
Photographic Mirrors

Article#	L	W	H
WI11-469	140	80	15
WI11-470	170	70	15
WI11-471	200	80	15



**HOLLOWWARE  
SECTION 11**

■ Оттисные ложки  
■ Porte-empainte  
■ Abdrucklöffel

■ Відбиткові ложки  
■ Cubetas para impresiones  
■ صواني الانطباع



Article#	L	W	H	
WI11-472	195	80	32	05 - instruments
WI11-473	195	105	32	07 - instruments
WI11-474	195	140	32	10 - instruments
WI11-475	280	195	32	20 - instruments

Article#	L	W	H	
WI11-476	190	70	32	05 - instruments
WI11-477	190	102	32	07 - instruments
WI11-478	190	135	32	10 - instruments

HOLLOWWARE INSTRUMENTS

**CASSETTE FOR ORTHODONTIC PLIERS**



Article#	L	W	H	
WI11-479	185	58	78	04 - Orthodontic Pliers & accessories area
WI11-480	185	85	78	06 - Orthodontic Pliers & accessories area
WI11-481	185	130	78	10 - Orthodontic Pliers & accessories area

12-Pcs Extracting Pliers

Article#	L	W	H
WI11-482	380	230	40



04 - Orthodontic Pliers & Instruments

Article#	L	W	H
WI11-483	203	178	24

06 - Orthodontic Pliers & 4 Instruments

Article#	L	W	H
WI11-484	203	240	24

Article#	L	W	H	
WI11-485	187	150	70	for 10 Pliers

# THANK YOU

FOR TAKING THE TIME TO EXPLORE OUR CATALOG

At Wittex International, we are committed to delivering **precision-crafted dental instruments** manufactured to the highest quality standards.

Our dedication to **excellence, durability, and clinical performance** ensures instruments you can trust every day.

We look forward to supporting your practice with **accuracy, reliability, and innovation.**

*Witex International*

 Wazirabad Road, Harar Sialkot 51310 - Pakistan

 +92 52 3574265 | +92 52 3574266

 [witex.export@gmail.com](mailto:witex.export@gmail.com)

 [www.witex.com](http://www.witex.com)